



EUROPEAN COMMISSION  
DIRECTORATE-GENERAL  
TAXATION AND CUSTOMS UNION

Brussels, 26 October 2023

## **GUIDANCE DOCUMENT ON CBAM IMPLEMENTATION FOR INSTALLATION OPERATORS OUTSIDE THE EU**

*This guidance document represents the views of the European Commission Services at the time of publication. It is not legally binding.*

## VERSION HISTORY

Date	Version notes
17 Aug 2023	First Publication
26 Oct 2023	<p>The following corrections were made:</p> <ul style="list-style-type: none"><li>• Some clarification in section 6.7.3 (electricity and CHP)</li><li>• Improvement of worked sector examples, in particular<ul style="list-style-type: none"><li>• cement, section 7.1.3 (minor clarifications)</li><li>• steel (7.2.2.1, in particular calculation of the waste gas deduction)</li><li>• mixed fertilizer (section 7.3.2, minor clarifications)</li><li>• Aluminium (section 7.4.2 minor clarifications)</li><li>• Hydrogen (section 7.5.2 – not all produced H<sub>2</sub> is sold)</li></ul></li><li>• Various typos, references and formats corrected.</li></ul>

## CONTENTS

<b>1</b>	<b>SUMMARY</b>	<b>6</b>
<b>2</b>	<b>INTRODUCTION</b>	<b>7</b>
2.1	About this document	7
2.2	How to use this document	8
2.3	Where to find further information	8
<b>3</b>	<b>QUICK GUIDE FOR OPERATORS</b>	<b>11</b>
<b>4</b>	<b>THE CARBON BORDER ADJUSTMENT MECHANISM</b>	<b>19</b>
4.1	Introduction to the CBAM	19
4.2	Definitions and scope of emissions covered in the CBAM	20
4.3	Transitional period	21
4.3.1	Key reporting roles and responsibilities	22
4.3.2	What needs to be monitored by you (as an operator)	23
4.3.3	Reporting periods for operators and importers	24
4.3.4	Governance of the CBAM	26
4.3.5	Inward processing	27
<b>5</b>	<b>CBAM GOODS AND PRODUCTION ROUTES</b>	<b>29</b>
5.1	Foreword to sector specific sections	29
5.2	Identifying CBAM goods	30
5.2.1	Product specifications	30
5.2.2	Identifying goods in scope for the CBAM Regulation	30
5.3	Cement sector	31
5.3.1	Unit of production and embedded emissions for industry sector	31
5.3.2	Definition and explanation of goods covered	32
5.3.3	Definition and explanation of relevant production processes and routes	33
5.4	Chemicals sector – Hydrogen	37
5.4.1	Unit of production and embedded emissions	38
5.4.2	Definition and explanation of sector CBAM goods covered	38
5.4.3	Definition and explanation of relevant production processes and routes	39
5.5	Fertilizers sector	42
5.5.1	Unit of production and embedded emissions	43
5.5.2	Definition and explanation of sector CBAM goods covered	44
5.5.3	Definition and explanation of relevant production processes and routes	45
5.6	Iron and Steel sector	50
5.6.1	Unit of production and embedded emissions	50
5.6.2	Definition and explanation of sector CBAM goods covered	51

5.6.3	Definition and explanation of relevant production processes and emissions covered	56
5.7	Aluminium sector	69
5.7.1	Unit of production and embedded emissions	69
5.7.2	Definition and explanation of sector goods covered	70
5.7.3	Definition and explanation of relevant production processes and routes	72
6	MONITORING AND REPORTING OBLIGATIONS	79
6.1	Definitions and scope of emissions covered in the CBAM	81
6.1.1	Installation, production process and production routes	81
6.1.2	Activity level, quantity of goods produced	81
6.1.3	Direct and indirect embedded emissions	82
6.1.4	Units for reporting embedded emissions	84
6.2	How to determine embedded emissions	84
6.2.1	The concept	84
6.2.2	From installation's emissions to goods' embedded emissions	85
6.3	Defining production process system boundaries and production routes	96
6.4	Planning your monitoring	100
6.4.1	What documentation is needed to plan your monitoring	100
6.4.2	Monitoring methodology principles and procedures	101
6.4.3	Written procedures	102
6.4.4	Choosing best available data sources	102
6.4.5	Limiting monitoring-related costs	105
6.4.6	Control measures and quality management	106
6.5	Determine installation's direct emissions	107
6.5.1	Calculation based approach	110
6.5.2	Measurement based Methodology – Continuous Emission Measurement Systems (CEMS)	122
6.5.3	Non-EU country specific methods	125
6.5.4	Treatment of biomass emissions	126
6.5.5	Determine PFC (perfluorocarbon) emissions	127
6.5.6	Rules for transfers of CO <sub>2</sub> between installations	128
6.6	Determine installation's indirect emissions	130
6.7	Rules required for attributing emissions to production processes	131
6.7.1	Generic rules for metering of parameters to be attributed to production processes	131
6.7.2	Rules for heat energy and emissions	134
6.7.3	Rules for electrical energy and its emissions	141
6.7.4	Rules for combined heat and power	143
6.7.5	Rules for waste gas energy and emissions	146
6.8	Calculation of embedded emissions of goods	148
6.8.1	Rules for goods produced	148
6.8.2	Rules for monitoring of precursor data	150
6.9	Use of default factors and other estimation methods	152
6.9.1	Default specific embedded emission values	152

6.9.2	Default emission factors for grid electricity	153
6.9.3	Minor data gaps in installation’s monitoring data	153
6.10	Reporting the effective carbon price due	154
6.11	Reporting template	156
6.11.1	For operators	158
6.11.2	For reporting declarants	160
7	SECTOR SPECIFIC MONITORING AND REPORTING	162
7.1	Cement sector	163
7.1.1	Sector-specific requirements for monitoring and reporting	163
7.1.2	Example for splitting a cement installation into separate production processes	167
7.1.3	Worked example for the cement sector	170
7.2	Iron and Steel sector	174
7.2.1	Sector-specific requirements for monitoring and reporting	175
7.2.2	Worked examples for the iron and steel sectors	177
7.3	Fertilizers sector	191
7.3.1	Sector-specific requirements for monitoring and reporting	192
7.3.2	Worked example for the fertilizer sector	195
7.4	Aluminium sector	197
7.4.1	Sector-specific requirements for monitoring and reporting	198
7.4.2	Worked example for the aluminium sector	202
7.5	Chemicals – Hydrogen sector	208
7.5.1	Sector-specific requirements for monitoring and reporting	208
7.5.2	Worked examples for the hydrogen sector	211
7.6	Electricity “as a good” (i.e. imported into the EU)	216
7.6.1	CO <sub>2</sub> emission factor based the reporting declarant’s data	217
7.6.2	CO <sub>2</sub> emission factor based on actual CO <sub>2</sub> emissions of the installation	218
8	EXEMPTIONS FROM THE CBAM	219
ANNEX A	LIST OF ABBREVIATIONS	220
ANNEX B	LIST OF DEFINITIONS	222
ANNEX C	DEFAULT VALUES	230
ANNEX D	– FURTHER INFORMATION ON BIOMASS	241
ANNEX E	– STANDARD VALUES FOR EMISSION CALCULATIONS	249

## 1 SUMMARY

The Carbon Border Adjustment Mechanism (CBAM) is an environmental policy instrument designed to apply the same carbon costs to imported products as would be incurred by installations operating in the European Union (EU). In doing so, the CBAM reduces the risk of the EU's climate objectives being undermined by production relocating to countries with less ambitious decarbonisation policies (so-called 'carbon leakage').

Under the CBAM, in its definitive (post-transitional) period EU authorised declarants representing the importers of certain goods will purchase and surrender CBAM certificates for the embedded emissions of their imported goods. As the price for those certificates will derive from the EU Emission Trading System (EU ETS) allowance price, and since Monitoring, Reporting and Verification (MRV) rules have been designed based on the MRV system of the EU ETS, this will equalise the price of carbon incurred between imported goods and goods produced in installations participating in the EU ETS.

This guidance document is part of a series of guidance documents and electronic templates provided by the European Commission to support the harmonised implementation of the CBAM during **the transitional period (1 October 2023 to 31 December 2025)**. It provides an introduction to the CBAM and the concepts to be used for monitoring and reporting of stationary installations. This guidance does not add to the mandatory requirements of the CBAM, but it is aimed at assisting correct interpretation to facilitate implementation.



*This guidance document represents the views of the European Commission Services at the time of publication. It is not legally binding.*

## 2 INTRODUCTION

### 2.1 About this document

This document has been written to support stakeholders by explaining the requirements of the CBAM Regulation in a non-legislative language. This guidance focuses on the **requirements for operators of installations producing CBAM goods outside of the EU for the transitional period, from 1 October 2023 to 31 December 2025**, during which time the CBAM is applied without a financial obligation for importers and solely for data collection purposes.

- **Section 3** provides a quick guidance for the intended reader of this document, the operator of an installation producing CBAM goods. It gives a roadmap to the most important concepts of CBAM emissions monitoring and where to find more information in this document.
- **Section 4** provides an introduction to the CBAM and an overview of the compliance cycle, roles and responsibilities and milestones and deadlines for operators of installations outside the EU during the transitional period.
- **Section 5** presents an overview of the production processes and value chains for the sectors and goods that are included in the scope of the CBAM.
- **Section 6** sets out the monitoring and reporting obligations and recommendations which are potentially applicable to any affected producer of CBAM goods.
- **Section 7** adds to this with sector specific monitoring and reporting considerations for each CBAM good where this is relevant. The section is supplemented by examples for each sector.
- **Section 8** explains the general exemptions from the CBAM.

A separate guidance document is provided by the European Commission for importers of CBAM goods (“reporting declarants”). The guidance documents are accompanied by an electronic template for information that should be used by installation operators to communicate information to the reporting declarants.



#### **Presentation of numbers in EU documents**

To align with EU legal documents, this guidance document uses the following convention when presenting numbers.

The decimal separator used to separate the integral part of a number from its fractional part is a comma, e.g.: 0,890





Thousands, and powers of  $10^{3n}$  thereafter, are separated by a space, e.g.:

- fifteen thousand is written as 15 000
- fifteen million is written as 15 000 000

## 2.2 How to use this document

Where article numbers are given in this document without further specification, they always refer to the CBAM Regulation<sup>1</sup>. Where the ‘Implementing Regulation’ is cited, it means the Regulation<sup>2</sup> which sets out the detailed MRV rules for the transitional period. For acronyms and definitions used in this document, please see Annex A and Annex B.

A series of icons are used throughout to help guide the reader:

Icon	Description of use
	Points to information of particular importance for operators of installations producing CBAM goods.
<b>Simplified!</b>	Highlights simplified approaches of the general requirements of the CBAM.
	Used where recommended improvements are presented
	Used where other documents, templates or electronic tools are available from other sources
	Points to examples given for the topics discussed in the surrounding text.
	Highlights sections that refer to the definitive period of the CBAM, rather than the transitional period

## 2.3 Where to find further information

The textbox below signposts the key sections of the CBAM Regulation and the Implementing Regulation that are **relevant to operators of installations producing CBAM goods during the transitional period**.

---

### The CBAM Regulation

Regulation (EU) 2023/956 of the European Parliament and of the Council of 10 May 2023 establishing a carbon border adjustment mechanism.

Available from: <http://data.europa.eu/eli/reg/2023/956/oj>

---

<sup>1</sup> Regulation (EU) 2023/956 of the European Parliament and of the Council of 10 May 2023 establishing a carbon border adjustment mechanism; Available from : <http://data.europa.eu/eli/reg/2023/956/oj>

<sup>2</sup> Commission Implementing Regulation (EU) 2023/1773 of 17 August 2023 laying down the rules for the application of Regulation (EU) 2023/956 of the European Parliament and of the Council as regards reporting obligations for the purposes of the carbon border adjustment mechanism during the transitional period; Available from: [http://data.europa.eu/eli/reg\\_impl/2023/1773/oj](http://data.europa.eu/eli/reg_impl/2023/1773/oj)



- 
- **Article 2** – sets out the scope of the CBAM with reference to Annex I.
  - **Article 3 and Annex IV** – provide definitions for common terms used in the CBAM.
  - **Article 10** – sets out requirements for operator registration under the CBAM (*from 31 December 2024*).
  - **Article 30** – requires the European Commission to undertake a review of the scope of the CBAM by 31 December 2024.
  - **Articles 32 to 35** – set out the reporting obligations on EU importers in the transitional period.
  - **Article 36** – sets out the dates from when the other articles start to apply.
  - **Annex I** – provides the list of CBAM goods by industry sector with CN code to identify goods, and the corresponding relevant greenhouse gases.
  - **Annex III** – identifies the non-EU countries and territories that are not covered by the CBAM.
  - **Annex IV** – provides the general methods for calculating the embedded emissions in goods; in section 2 for Simple Goods and in section 3 for Complex Goods.

**Implementing Regulation (pursuant to Article 35(7) of the CBAM Regulation):**

Commission Implementing Regulation (EU) 2023/1773, available from:

[http://data.europa.eu/eli/reg\\_impl/2023/1773/oj](http://data.europa.eu/eli/reg_impl/2023/1773/oj)

- **Article 2 and Annex II** Section 1 – provide definitions for common terms used in the CBAM and the MRV rules.
  - **Article 3** – provides the reporting obligations of the reporting declarants, including the parameters for which data is to be reported.
  - **Articles 4 and 5** – set out the approaches for the calculation of the embedded emissions and conditions for the use of default values.
  - **Article 7** – indicates the information to be reported regarding the carbon price due.
  - **Article 16** – relates to the penalties that shall be applied by Member States if the reporting declarant has not correctly fulfilled its reporting obligations.
  - **Articles 19 and 22** – set out technical elements of the CBAM Transitional Registry.
  - **Annex I:** Table 1 - CBAM Report Structure, Table 2 - Detailed information requirements in the CBAM report.
  - **Annex II:** Section 2, Table 1 – mapping of CN codes to the CBAM aggregated goods categories; and Section 3 – definition of production processes for the CBAM goods categories, including system boundaries of production routes and relevant precursors.
-

- 
- **Annex III:** Rules for monitoring emissions at installation level, for attributing them to production processes, and for determining specific direct and indirect embedded emissions of simple and complex goods. It is structured in sections as follows:
    - A. Principles
    - B. Monitoring of direct emissions at installation level
    - C. Monitoring of heat flows
    - D. Monitoring of electricity
    - E. Monitoring of precursors
    - F. Rules for attributing emissions of an installation to goods
    - G. Calculation of specific embedded emissions of complex goods
    - H. Optional measures to increase quality of data
  - **Annex IV:** Minimum data to be reported by producers of goods (“operators”) to importers (or reporting declarants).
  - **Annexes V to VII:** Tables listing data requirements for other reports, including for inward processing (by importers), EORI and the National Import System.
  - **Annex VIII:** Standard factors that may be used for the monitoring of direct emissions.
  - **Annex IX:** Reference values for efficiency of separate production of heat and electricity, to be used in CHP calculations.
- 

All EU legislation can be found on: [eur-lex.europa.eu/homepage.html](https://eur-lex.europa.eu/homepage.html)

Other guidance and training materials that have been produced by the European Commission to help operators and importers include:

- A separate guidance document is provided by the European Commission for importers of CBAM goods into the EU (“reporting declarants”).
- Guidance developed for importers on how to complete quarterly reports on the CBAM Trader Portal.
- Excel-based template for operators to automatically calculate embedded emissions and communicate this data clearly to importers of goods
- Training videos.

The guidance documents and template are available on **the dedicated website** for the CBAM of the European Commission: [https://taxation-customs.ec.europa.eu/carbon-border-adjustment-mechanism\\_en](https://taxation-customs.ec.europa.eu/carbon-border-adjustment-mechanism_en)



### 3 QUICK GUIDE FOR OPERATORS

In this section we provide a step-by-step overview of important concepts, rules and obligations under the transitional period.

#### **Are you an operator of an installation producing “CBAM goods”?**

CBAM goods are goods currently imported into the EU from the cement, iron and steel, aluminium and some chemical industries (fertilizers and hydrogen), and electricity. To answer this question, you must compare the CN codes<sup>3</sup> of your products against the list of goods given in Annex I to the CBAM Regulation. More information on how to approach this can be found in Section 5.2 of this document, and subsequent sub-sections within section 5 set out further detail for each sector.

If you do not produce such goods, you do not have to read this document. However, it is written to be of help also to all other kinds of interested audiences (academia, CBAM importers, GHG verifiers, competent authorities, consultants, etc.). **If you just want to understand how the CBAM works in general**, you may find an introduction to the CBAM in Section 4.

#### **Are you exporting your goods to customers in EU Member States?**

The CBAM affects you if this is the case.

**Please note** that your products may also be purchased by clients who themselves manufacture CBAM goods, and your products may serve as “precursor” for their CBAM goods, which then may be exported to EU countries. Also, if you sell your products to traders who then sell them to EU customers, your goods fall under the CBAM.

In all those cases where CBAM goods end up in being imported into the EU, at some point the importer will contact you to gather information on the “embedded emissions” of these CBAM goods. Alternatively, the operator using your goods as precursor for producing other CBAM goods will ask the level of embedded emissions. **Therefore, you must be prepared to provide these data** and as soon as possible start to develop a monitoring methodology at your installation, as described in this guidance document.

**What are embedded emissions?** The concept has been developed to reflect as much as possible the way in which emissions are covered by the EU ETS if the CBAM goods were produced in the EU. The EU ETS requires operators to pay a price for their own (“direct”) emissions. However, if they consume electricity, they also experience the CO<sub>2</sub> costs included in the price of electricity they purchase<sup>4</sup> (“indirect emissions”). The same applies to the input materials needed for their production process, and which may be supplied by an EU ETS installation. These so-called precursors therefore contribute to the CO<sub>2</sub> costs the EU ETS installation faces. The “embedded emissions” are defined in parallel to the emissions causing CO<sub>2</sub> costs in the EU ETS: they take into account the direct and indirect<sup>5</sup> emissions of the production process as well as the embedded emissions of precursors. They are similar in concept to a carbon footprint of the goods. The scope of the CBAM is

---

<sup>3</sup> CN (Common Nomenclature) codes are the EU version of the HS (Harmonised System) codes for international trade. CN codes consist usually of 8 digits (the first 6 digits are identical to the HS code). Where Annex I to the CBAM Regulation contains fewer digits, it means that all CN codes starting with those digits are covered.

<sup>4</sup> If the EU installation produces its own electricity, it experiences the CO<sub>2</sub> costs directly.

<sup>5</sup> Indirect emissions have to be reported for *all* CBAM goods during the transitional period. Although at this stage only a smaller number of goods is included in Annex II to the CBAM Regulation, and only those will have to cover indirect emissions in the definitive period.

principally related to the rules of the EU ETS and therefore has differences to other methods for calculating product carbon footprints such as the “GHG Protocol” or ISO14067.

A detailed introduction to the concept and calculation of embedded emissions is given in section 6.2.

**What do you need to monitor?** To answer this question, you need to perform the following steps to develop your “monitoring methodology documentation”, i.e. the handbook you and your personnel use as a basis for performing monitoring tasks in a consistent way during the coming years. The presented steps will ensure that all the data which you need to calculate embedded emissions is covered.

- Step 1: Define the **installation’s boundaries**, production processes and production routes. Production process means the system boundaries which are needed to attribute emissions to specific goods produced<sup>6</sup>. Each “Aggregated good category” (i.e. an aggregation of goods with different CN codes, but suitable to be covered by common monitoring rules) corresponds to one production process. Guidance on system boundaries is found in Section 5.2 and for each sector specific sub section in Section 5.
- Step 2: Define the **reporting period** you are going to use. The default case is the (European) calendar year. However, if your installation is situated in a country with a different calendar, or where there are other reasonable arguments for a different period, this may be used, too, if it covers at least three months. Suitable alternative periods include, in particular, the reporting periods of a carbon pricing scheme or compulsory emissions monitoring scheme in the country of your installation, or the fiscal year used. The main reason for choosing such other periods is that there may be additional scrutiny applied for those purposes, such as stock taking and financial auditing for annual financial accounts, or third-party verification of emissions, which gives a higher level of confidence in the quality of your data when also used for CBAM purposes. Further guidance on reporting periods is given in Section 4.3.3.
- Step 3: Identify all the **parameters you need to monitor**:
  - **Direct emissions** of the installation: you have two options available:
    - a) The “calculation-based” approach, where you need to determine the **quantities of all fuels and relevant materials**<sup>7</sup> consumed, and corresponding “calculation factors” (in particular the so-called “**emission factor**” based on the carbon content of the fuel or material);
    - b) The “measurement-based” approach, where you need to measure online the **concentration of the greenhouse gases** as well as the **flow of the flue gas** for each “emission source” (stack).

Note, however, that **during an introductory phase until 31 July 2024 you may apply other methods allowed for emissions monitoring in your jurisdiction**, if they lead to a similar emission coverage and accuracy. These other methods may include default values made available and published by the European Commission for the transitional period. Other default values can be used on the

---

<sup>6</sup> If you are familiar with the EU ETS, it may help you to understand the concept of “production process” that it is very similar to the “sub-installations” used for benchmarking.

<sup>7</sup> The term “source stream” is used to cover both, fuels and other input or output materials that have an influence on emissions.

condition that the reporting declarant indicates and references in the CBAM reports the methodology followed for establishing such values. For PFC<sup>8</sup> emissions from primary aluminium production a special methodology based on overvoltage measurements should be applied. For N<sub>2</sub>O emissions from nitric acid production, the measurement-based method is compulsory. In all other cases, you may choose which method best fits to the situation of your installation.

Additionally, if your installation has more than one production process, there may be a need to monitor fuel or material streams between the production processes in order to enable correct attribution of emissions to production processes<sup>9</sup>.

The rules for monitoring these direct emissions are found in Annex III, section B of the Implementing Regulation. Section 6.4 of this document gives relevant guidance on details.

- **(Direct) emissions related to heat flows**<sup>10</sup>: Heat consumption (both heat produced in the installation or received from a separate installation) needs to be attributed to each production process, and emissions related to heat exported from production processes need to be deducted from the attributed emissions of each production process from where the heat is produced or recovered. Therefore, rules for **monitoring heat flows** are found in section C of Annex III to the Implementing Regulation. There are also rules on determining the **emission factor of heat**. Detailed guidance is found in Section 6.7.2 of this document.
- **Indirect emissions**: These are emissions occurring during the production of the electricity your installation consumes for its production processes, irrespective of whether this electricity was produced within the installation or imported from outside. You need to monitor the quantities of **electricity consumed** in each production process and multiply it by the relevant emission factor of electricity. For the emissions factor, the following options exist:
  - a) If the electricity comes from the grid, you use the **default emission factor** provided by the European Commission based on IEA<sup>11</sup> data.
  - b) If you produce electricity yourself in your installation (you are an “auto-producer”), you need to monitor the emission of the power plant or CHP

---

<sup>8</sup> Perfluorocarbons.

<sup>9</sup> For example, if a blast furnace produces pig iron, a part of the waste gases is usually used as fuel in other parts of the installation (e.g. a power plant or a hot-rolling mill). In such a case, the quantity and calculation factors need to be determined also for this waste gas, although they are not necessary to calculate the total emissions of the installation.

<sup>10</sup> Note 1: this is only about “**measurable heat**”, i.e. heat that is transported via a heat medium such as steam, hot water, liquid salts, etc. and where its flow rate can be measured in a pipe, duct, etc. Where heat is produced in a burner and directly used e.g. in a kiln or dryer there is no need to monitor the heat flow, instead the emissions are determined from the fuel consumption. On the other hand, measurable heat is often produced centrally or at several points in the installation, which do not directly correspond to the system boundaries of production processes. It is therefore useful to determine the emissions of the heat production separately, and attribute the emissions to production processes via the heat consumed in each production process.

Note 2: In context of carbon footprints, emissions from (imported) heat is often considered “scope 2 emissions” and therefore termed “indirect emissions”. Please be aware that in the CBAM legislation as well as in this document, the expression “indirect emissions” refers only to electricity, not heat.

<sup>11</sup> International Energy Agency.

plant<sup>12</sup> in the same way as you monitor other direct emissions of your installation, and **use specific rules to calculate the emission factor from the fuel mix** and taking into account CHP heat production, if applicable. The relevant rules are found in section D of Annex III to the Implementing Regulation. Section 6.7.2 and section 6.7.4 of this document provide guidance on heat and CHP.

- c) If you receive electricity from a specific installation under a “power purchase agreement”, provided this power plant monitors its emissions in line with the same rules as applicable for auto-produced electricity and communicates that information to you appropriately, you may use the resulting emission factor for this electricity.

Detailed guidance is found in Section 6.7.3 of this document.

- o **Precursors:** As explained under point 3 above, the concept of embedded emissions includes the addition<sup>13</sup> of embedded emissions of certain materials used in the production process, the so-called precursors. **Which precursors are relevant** to each production process is listed in section 3 of Annex II of the Implementing Regulation and is discussed in Section 5 of this document for each affected sector. The following parameters need to be monitored for each precursor material:

- a) **If the precursor is produced within your installation**, all relevant monitoring is already done in line with the above points. You only need to take the precursor’s embedded emissions into account when calculating the embedded emissions of the goods which use the precursor in the production process.
- b) **If you purchase the precursor** from other installations, you need to request data from the relevant producers in the same way as you are asked for data when your goods are imported into the EU. The relevant information includes the following, for each precursor, **separately for each installation of its production**:
  - Identification of the installation where it was produced;
  - The specific<sup>14</sup> direct and indirect embedded emissions of the precursor;
  - The production route, and additional parameters that the importer needs to report when the final good is imported to the EU under the CBAM. These additional parameters are listed in section 2 of Annex IV to the Implementing Regulation and discussed in section 5 and section 7 of this document for each affected sector.
  - The reporting period applied by the producer of the precursor.
  - If applicable, information on a carbon price due in the relevant jurisdiction production of the precursor (see point 5 below).

---

<sup>12</sup> CHP means combined heat and power, also known as “cogeneration”.

<sup>13</sup> Note the difference between precursors and normal input materials: For the determination of direct emissions it is taken into account that the carbon atoms contained in a material may be oxidised to CO<sub>2</sub> and emitted. However, for *precursors*, additionally the emissions which took place already earlier (during their own production), i.e. the precursor’s embedded emissions, need to be added.

<sup>14</sup> Specific (embedded) emissions means emissions related to one tonne of the material under discussion.

- c) In both cases, i.e. for purchased or self-produced precursors, you need to monitor the **quantity of each precursor you used** during the reporting period for each of your production processes.

The rules for monitoring precursor-related data are found in section E of Annex III to the Implementing Regulation. More details are given in Section 6.8.2 of this document.

- Finally, there are some **additional qualifying parameters** that the EU importer needs to report under the CBAM. These depend on the goods produced. For example, for cements imported, the total clinker content needs to be reported, for mixed fertilizers the contents of the different forms of nitrogen, etc. The relevant parameters are listed in section 2 of Annex IV to the Implementing Regulation. You need to ensure that you collect all the parameters necessary for your CBAM goods and communicate them to the importers of your goods. Guidance can be found in Section 5 of this document.
- **Step 4: Determine the methodology to monitor each parameter** you have identified:
  - For **quantities of fuels and materials** (including precursors) used, you may either have measurement instruments available which tell you how much has been consumed during the reporting period (e.g. weighing belts, flow meters, heat meters, etc.) or you may determine the used amounts from purchase records and stock measurements at the end of each period.
  - For the so-called **calculation factors** (e.g. the carbon content of the fuel or material) you can either choose a “standard value” from applicable literature (in particular national GHG inventories submitted under the UNFCCC/ Paris Agreement) or from Annex VIII to the Implementing Regulation, or you can determine them based on laboratory analyses, for which the Implementing Regulation provides further rules in section B.5 of Annex III.
  - For continuous emission measurements, heat flow and electricity measurements you also need to define the **instruments to use**, and applicable calibration and maintenance measures.
  - In some cases, it may be necessary to define **estimation methods**, or **indirect methods** based on known correlations of measurement parameters.
  - As the very last resort, if you have no other methods available for monitoring your goods’ embedded emissions, and in particular if the producer of your precursors used does not provide the required data, you may use the **default values for embedded emissions** of CBAM goods (which include all relevant precursors) which the European Commission makes available for the purpose. A list of the goods for which default values are available is given in Annex C of this document with further guidance on their use in Sections 6.9.

Note that sometimes you may have the choice of different monitoring approaches (e.g. you may have more than one measurement instrument, or you need to choose between continual metering and use of batch-wise delivery records, choose between calculation-based and measurement-based methods, etc.) The Implementing Regulation contains provisions in section A.3 of Annex III on how to select the best available (i.e. most accurate) data source. Details are discussed in Section 6.4 of this document.

**Do you pay a carbon price in your own jurisdiction?** To ensure similar treatment between installations in the EU ETS and in other countries, a carbon price due in the

country where a CBAM good is produced will allow for a reduction in the CBAM obligation in the definitive period from 2026 onwards. This is already a reporting obligation during the transitional period of the CBAM (namely until the end of 2025). You need to ensure that you include information on carbon pricing in your monitoring methodology, so you can convey the relevant information to the importer of your CBAM goods. During the transitional period such reporting on the carbon prices due around the world is important for the European Commission to consider any further improvements of the CBAM legislation in that regard.

If your installation is subject to a carbon price, you will have to collect information on the carbon price due, in such a way that you can attribute it to production processes and CBAM goods categories in a similar way as you attribute emissions to the goods. The *effective* carbon price is to be considered, i.e. taking into account any applicable rebates (in case of an ETS, any free allocation is considered a rebate).

Note that you need to collect **information for each precursor purchased** if a carbon price applies in its country of origin. If the producer of the precursor does not provide the required information, you must assume the carbon price due for the precursor to be zero.

The total effective carbon price needs to be attributed to the CBAM goods in a similar way as the specific embedded emissions, i.e. it needs **to be expressed as euros per tonne of CBAM good**.

The reporting rules of information regarding the carbon price due are found in Article 7 of the Implementing Regulation. Detailed guidance is given in section 6.10 of this document. **Compile the monitoring methodology documentation (MMD)**

At this point you have listed all the monitoring methods for all the materials or emission sources you need to monitor throughout the year. You should put all of this information together into one written documentation (a “CBAM management handbook” of your installation) so that the methodology can be consistently used over the coming years. This should be done in a systematic way (e.g. by listing all measurement instruments, all reading intervals, all data sources for standard values). It is also advisable to use a diagram of the installation where all the necessary instruments, sampling points etc. are indicated.

The guiding principle for setting up this monitoring methodology documentation is that it should be sufficiently clear and transparent so that independent persons, who have some knowledge of GHG monitoring, are enabled to understand the monitoring methodology. It needs to be detailed enough to serve as instructions to the installation’s personnel to perform all necessary tasks for determining the embedded emissions of goods. It must therefore also contain the applicable calculation steps, and all calculation factors which are not determined by analyses.

Guidance on setting up a MMD is given in Section 6.4 of this document. It may also be helpful to check the monitoring methodology against the “communication template” provided by the European Commission (see point 8 below). You may want to use the data requirements of that template for checking the completeness of the MMD.

Furthermore, the MMD needs to contain control measures in the data flow from primary data to final specific embedded emissions. These measures must be commensurate with the risks for errors. Measures should include frequent checking by an independent person, and comparing data from different sources, consistency checking of time series, etc. More guidance is found in section 6.4.6 of this document. **Perform monitoring throughout the reporting period:** While all the steps above are necessary only once to prepare your installation and its staff for the monitoring tasks, this and the following point are to be performed continuously throughout all the following years.



You have to perform the monitoring tasks defined in the MMD. You have to regularly read fuel meters, take stock of materials consumed or produced, take samples of fuels or materials to be analysed, carry out maintenance, control and calibration of measuring instruments, etc. You need to collect the relevant data, perform calculation of emissions, and perform all relevant quality control and assurance measures defined in the MMD.

Furthermore, at least once per reporting period, you should review the MMD and check if it is still accurate and appropriate. For instance, does it still reflect the technologies used in your installation, is the list of produced goods still up to date? Have new fuels or materials become relevant? Can you use better (more accurate) monitoring methods, can you reduce the risk for errors in the data flow? All changes and improvements should be documented in the MMD, and you should ensure that only the latest version of the MMD is used. You may also consider verification by a third-party GHG verifier as a voluntary means to identify weak points in your monitoring methodology and to improve it. Finally, you must **communicate the embedded emissions data of your CBAM goods to the EU importer(s)** who bear(s) the reporting obligation under the CBAM Regulation. As you may sell your goods to a multitude of clients, there may be a large number of EU importers who must request this information from you. In order to perform this communication as efficiently as possible, the European Commission provides a common template that can be used for this purpose.

While the use of this template is voluntary, it needs to be highlighted that the use of a **common template greatly simplifies the communication** on both ends. Your customers may be established in different EU Member States and may speak different languages, and may themselves purchase CBAM goods from many suppliers in different countries. The common template ensures a common reporting format, so that the same type of information can always be found in the same field in the template, and the meaning of each field will also be clear.

Whenever your chosen reporting period ends (e.g. after the end of a calendar year), you must **compile the monitored data of the whole reporting period**, determine the attributed emissions of each production process, and divide them by the corresponding “activity level” (i.e. the total tonnes of goods under the related CBAM category produced within the reporting period) in order to get the **specific embedded emissions of this good**. This is the main parameter the EU importer is interested in (plus the additional qualifying parameters mentioned under point 4 step 3 above). Until you finalise the data compilation of the following reporting period, you should use these embedded emissions data (using the template you have filled for this reporting period) and provide it to all your customers who need them for CBAM purposes.

The template can be found on the European Commission’s dedicated website for the CBAM. It has been designed based on the rules set out in Annex IV to the Implementing Regulation on the content of the recommended communication from operators of installations to reporting declarants. More guidance on compiling relevant information for importers and using the template is given in Section 6.11 of this document and directly within the template.

**What happens after the transitional period.**

From 2026, the definitive period of the CBAM will apply. That means from 1 January 2026 onwards, importers will have to bear a “CBAM obligation” in the form of certificates, which they purchase at the average price of EU ETS allowances, for every CBAM good imported into the EU. There will be a phase-in with increasing coverage of embedded emissions by the CBAM obligation from 2026. The full embedded emissions will only be covered from 2034 onwards<sup>15</sup>.

---

<sup>15</sup> The detailed calculation formula will be developed and published by the European Commission at a later stage.

## 4 THE CARBON BORDER ADJUSTMENT MECHANISM

### 4.1 Introduction to the CBAM

The Carbon Border Adjustment Mechanism (CBAM) is an environmental policy instrument designed to support the EU climate ambitions of achieving a net reduction of greenhouse gas (GHG) emissions of at least 55% by 2030 and of reaching climate neutrality by 2050 at the latest.

The CBAM complements the EU Emission Trading System (EU ETS), which was recently strengthened as part of the EU's "Fit for 55" legislative package. Under the EU ETS, operators of installations producing emission-intensive goods surrender emission allowances for each tonne of CO<sub>2</sub>e emissions. Since an (increasing) amount of these allowances are purchased in auctions or on the secondary market, these operators face a 'carbon price'<sup>16</sup> on their GHG emissions. However, most operators in non-EU countries do not have such an obligation, and this competitive advantage puts European production at risk of carbon leakage i.e. relocation outside the EU.

In order to mitigate the risk of carbon leakage prior to the CBAM, the relevant industry sectors have been receiving a part of their allowances free of charge ("free allocation") under the EU ETS. With the introduction of the CBAM, free allocation is gradually being phased out as the CBAM is gradually phased in. Instead of alleviating the carbon costs for EU operators, the CBAM ensures that importers of goods from non-EU countries bear similar carbon costs for the "embedded emissions" of the imported goods. This general guiding principle of both the EU ETS and the CBAM aims at incentivising emissions reductions on an equivalent basis between EU operators and non-EU operators exporting to the EU.

The CBAM does not target countries but the embedded carbon emissions of products imported into the EU for specific sectors that are within the scope of the EU ETS and the most at risk of carbon leakage. They include namely: cement, iron and steel, aluminium, fertilizers, hydrogen and electricity. It also includes some precursors and some downstream products of the aforementioned sectors (hereinafter referred to as "CBAM goods"). For a complete list of CBAM goods per sector see Section 5 of this document.

The CBAM will be introduced in phases as follows:

- **Transitional period** (1 October 2023 to 31 December 2025):  
Designed as a "learning phase", during which CBAM importers are required to report a set of data, including emissions embedded in their goods, *without paying a financial adjustment* for the embedded emissions. However, penalties may be imposed, for example for failing to submit the required *quarterly CBAM reports*.
- **Definitive period** (starting on 1 January 2026):
  - From 2026 to 2033, the embedded emissions for CBAM goods will gradually be covered by the CBAM obligation, as free allocation under the EU ETS is gradually phased out.

---

<sup>16</sup> More precisely, a price for the CO<sub>2</sub> or other equivalent greenhouse gas emissions.



- From 2034, 100% of embedded emissions of the CBAM goods will be covered by CBAM certificates and no free allocation will be given under the EU ETS for these goods.

The CBAM in the definitive period is designed to mirror the emission cost under the EU ETS:

- EU operators will pay the CO<sub>2</sub> price of their emissions and surrender allowances (EUAs) under the EU ETS; and
- EU importers of CBAM goods into the EU will surrender CBAM certificates that closely reflect the situation of the EU ETS, both in terms of MRV rules and of the price of the certificates.

The CBAM is designed in compliance with World Trade Organization (WTO) rules and other international obligations of the EU and is applied equally to imports from all countries outside the EU.<sup>17</sup>

**This document only deals with the requirements of the transitional period.**

This phase is meant for learning and setting up of the relevant MRV approaches outside the EU, and of institutions and information technology systems within the EU.

## 4.2 Definitions and scope of emissions covered in the CBAM

The textbox below signposts the key sections in the Implementing Regulation defining terms used for the CBAM.

---

*Implementing Regulation references:*

**The CBAM Regulation (EU) 2023/956, Chapter I Article 3 Definitions and Annex IV Definitions**

**Annex II, Section 1 Definitions, sub-section A.1. Definitions.**

A list of abbreviations and definitions used is also provided in annexes in the back of this guidance document.

---

The following terms are frequently used in this guidance document:

- **‘tonne of CO<sub>2</sub>e’** means one metric tonne of carbon dioxide (‘CO<sub>2</sub>’), or an amount of any other greenhouse gas listed in Annex I to the CBAM Regulation adjusted to the equivalent global warming potential of CO<sub>2</sub>.
- **‘Direct emissions’** means emissions from the production processes of goods, including emissions from the production of heating and cooling consumed during the production processes, regardless of the location of the production of the heating and cooling.

---

<sup>17</sup> The only exception are goods from countries that either apply the EU ETS (currently Iceland, Norway and Liechtenstein) or have an ETS fully linked with the EU ETS (currently Switzerland). Producers in these countries therefore face the same carbon price as in the EU.



- **‘Indirect emissions’** means emissions from the production of electricity, which is consumed during the production processes of goods, regardless of the location of the production of the consumed electricity.
- **‘Embedded emissions’** means emissions released during the production of goods, including the embedded emissions of relevant precursor materials consumed in the production process.
- **‘Relevant precursor material’** means a simple or complex good which has embedded emissions not equal zero and which is identified as being within the system boundaries for the calculation of embedded emissions of a complex good.
- **‘Simple goods’** means goods produced in a production process requiring exclusively input materials and fuels having zero embedded emissions.
- **‘Complex goods’** means goods other than simple goods.
- **‘Specific embedded emissions’** means the embedded emissions of one tonne of goods, expressed as tonnes of CO<sub>2</sub>e emissions per tonne of goods.
- **‘Specific embedded emissions’** means the embedded emissions of one tonne of goods, expressed as tonnes of CO<sub>2</sub>e emissions per tonne of goods.
- **‘Production process’** means the parts of an installation in which chemical or physical processes are carried out to produce goods under an aggregated goods category defined in Table 1 of Section 2 of Annex II of the Implementing Regulation, and its specified system boundaries regarding inputs, outputs and corresponding emissions.
- **‘Aggregated goods category’** is *implicitly* defined in the Implementing Regulation by listing the relevant aggregated goods categories and all the goods identified by their CN codes in Table 1 of Section 2 of Annex II.
- **‘Production route’** means a specific technology used in a production process to produce goods under an aggregated goods category. One production process usually relates to one group of CBAM goods produced (the ‘aggregated goods categories’). However, in some case more than one production route exists for producing these goods.

### 4.3 Transitional period

A summary of key elements of the transitional period is presented in Table 4-1.

*Table 4-1: Transitional period – key points*

Duration	1 October 2023 to 31 December 2025.
MRV rules	Implementing Regulation (EU) 2023/1773.
Reporting of indirect emissions	Required for all CBAM goods.

Default values for reporting of embedded emissions	Global values (except electricity). May be used for precursors of complex goods contributing up to 20% of the total for the complex good. Must be used for imports of electricity and for indirect emissions, unless certain criteria are met.
Flexibility regarding MRV rules	The use of rules from other (non-EU) carbon pricing or reporting schemes are allowed for operators of installations until the end of 2024, if they cover the same emissions and provide similar accuracy. Importers may use other (estimation) methods until 31 July 2024.
Frequency of reporting	Quarterly (importers).
Verification of reported data	Not required. Operators and importers should aim to report as accurately and completely as possible. If verification has been undertaken this should be noted in the submission.
Surrender of CBAM certificates	Not required.

#### 4.3.1 Key reporting roles and responsibilities

The “**reporting declarant**”<sup>18</sup> is the entity which is responsible for the reporting of embedded emissions of imported goods. In principle, the reporting declarant is the “**Importer**”. However, in practice there are different options depending on the person lodging the customs declaration. Where different actors are involved in the importation process, it is important to remember that every tonne of imported good is the *responsibility of exactly one reporting declarant*, i.e. that it is neither reported twice nor omitted from reporting.

In line with the options provided under the Union Customs Code (UCC<sup>19</sup>), the reporting declarant can be either<sup>20</sup>:

- The **importer who lodges a customs declaration** for release for free circulation of goods in its own name and on its own behalf;
- The **person, holding an authorisation** to lodge a customs declaration referred to in Article 182(1) of the UCC, who declares the importation of goods; or

<sup>18</sup> The Implementing Regulation uses this term in order to cover both situations, either where an importer or its indirect customs representative are responsible for the CBAM reporting.

<sup>19</sup> Regulation (EU) No 952/2013, consolidated version: <http://data.europa.eu/eli/reg/2013/952/2022-12-12>

<sup>20</sup> Article 2(1) of the Implementing Regulation.

- The **indirect customs representative**, where the customs declaration is lodged by the indirect customs representative appointed in accordance with Article 18 of the UCC, when the importer is established outside the Union or where the indirect customs representative has agreed to the reporting obligations in accordance with Article 32 of the CBAM Regulation.

The reporting declarant must provide a ‘CBAM report’ on a quarterly basis<sup>21</sup>, to the European Commission via the **CBAM Transitional Registry**, no later than one month after the end of that quarter. This is to report the information listed in Annex I of the Implementing Regulation on the goods imported into the EU during that quarter. Note the specific requirements, including on the date of importation, in case of the so-called “inward processing” customs procedure (see section 4.3.5).

The **operator of an installation** producing CBAM goods outside the EU is the second key role for the functioning of the CBAM. Installation operators are the persons who have direct access to information on the emissions of their installations. They are therefore responsible for **monitoring and reporting the embedded emissions of goods** they have produced and are exporting to the EU.

**Third-party verifiers** will play an important role in the definitive period. However, during the transitional period, verification is a fully voluntary measure which operators of installations may choose as a means to improve their data quality, and to prepare for the requirements of the definitive period.

Furthermore, the **competent authority in the EU Member State** where the reporting declarant is established plays an important role. It is in charge of enforcing the certain provisions of the CBAM Regulation, such as reviewing the CBAM reports to ensure that reporting declarants submit complete and correct quarterly CBAM reports, and to impose penalties in line with the Implementing Regulation, if necessary.

The European Commission (in this document also “**the Commission**”) is responsible for running the CBAM Transitional Registry, assessing the overall implementation of the CBAM during the transitional period by checking the information contained in the quarterly CBAM reports, for further developing the legislation with a view to the definitive period, and for co-ordinating the competent authorities in the EU Member States. Furthermore, the European Commission provides a dedicated website for the CBAM, with further guidance documents, templates for reporting, training material, and the portal to the CBAM Transitional Registry (which will be further updated to become the CBAM Registry in the definitive period).

#### **4.3.2 What needs to be monitored by you (as an operator)**

The first element is the monitoring of **direct emissions** of the installation. However, monitoring of an installation’s emissions is only the initial part of determining embedded emissions of a product. Whenever an installation produces several different products, the emissions must also be **appropriately attributed to the individual products**. Due to the specific rules for attributing emissions to goods, there is also a need to determine certain flows of heat (steam, hot water, etc.) to and from the installation, and between relevant

---

<sup>21</sup> Article 35 to the CBAM Regulation

production processes. The same applies to so-called “waste gases” (e.g. blast furnace gas in the steel industry). Both heat and waste gases contribute to the direct emissions.

You must also monitor and report to the reporting declarant(s) the quantities of specific input materials which themselves have embedded emissions (the so-called “precursors”) used in the manufacturing process and determine the **embedded emissions of these precursor materials**. Where you purchase precursors, you need to obtain data on the embedded emissions of precursor materials used in the production of the CBAM goods from the supplier of these precursors.

**Indirect emissions** released from the generation of the electricity consumed during the production of all CBAM goods similarly must be monitored for the purposes of the CBAM<sup>22</sup> and attributed to the goods produced. Again, emissions embedded in precursors must be included, where relevant.

Explanation of how to determine these embedded emissions and to define system boundaries are elaborated upon in Sections 5.2 and 5.

Finally, you must **communicate to the importer(s) the carbon price due in the production of the good within its own jurisdiction, if any**. This includes the carbon price per tonne CO<sub>2</sub>e and the amount of free allocation or any other financial support, compensation or rebate received per tonne of the product relevant for the CBAM. Notably, in case of complex goods, the carbon costs due by the producers of precursor materials should also be taken into account.

### ***4.3.3 Reporting periods for operators and importers***

The **reporting period** is the reference period for determining embedded emissions. Operators and importers have different reporting periods.

#### **Installation operators**

For you (an operator), the default reporting period is twelve months to allow them to collect representative data that reflects an installation’s annual operations.

The twelve-month reporting period may be either a:

- **Calendar year** – which is the default option for reporting; or alternatively a
- **Fiscal year** – if this can be justified on the basis that the data for a fiscal reporting year is more accurate, or to avoid incurring unreasonable cost; for example, where the financial year end coincides with an annual stock take of fuels and materials.

A period of twelve months is considered representative as this reflects seasonal variations in an installation’s operations, as well as any periods of disruption to the process resulting from planned annual shutdowns (e.g. for maintenance) and start-ups. A full year also helps

---

<sup>22</sup> During the transitional period, indirect emissions of *all* CBAM goods are to be monitored and reported, including the embedded indirect emissions of precursors. However, in the definitive period, indirect emissions will be included only for certain products (the goods included in Annex II to the CBAM Regulation).



to mitigate any data gaps e.g. by taking meter reads on either side of any missing periodic data points.

However, you may also choose an alternative reporting period, of a least three months, if the installation participates in an eligible MRV system and the reporting period coincides with the requirements of that MRV system. For example:

- A mandatory carbon pricing scheme (an emission trading system or carbon tax, levy or fee) or GHG reporting scheme with a compliance obligation. In this case that scheme's reporting period may be used, if it covers at least three months; or
- Monitoring and reporting for the purpose of another monitoring scheme (e.g. a GHG emission reduction project, which includes verification by an accredited verifier. In this case the reporting period of the applicable MRV rules may be used if it is at least three months.

In all the above cases, the direct and indirect embedded emissions of goods should be calculated as the **average of the reporting period** chosen.

In order to allow representative data to be reported from the start of the transitional period, operators should aim to share a full year of data for 2023 in January 2024, with importers, for the first quarterly report. In order to do this, you should:

- Collect emissions data and activity data from the start of the transitional period, for as much of 2023 as is available. For the period before actual emissions monitoring starts<sup>23</sup>, you should make estimates based on best available data (e.g. by using production protocols, backward calculation based on known correlations between known data and the relevant emissions, etc.).
- Start to collect data for the last quarter of 2023 in preparation for reporting a full year of data to importers, if possible, as early as possible at the start of January 2024.

In light of the above, you should therefore start preparing your monitoring methodology as soon as possible and aim to start actual monitoring as soon as possible after 1 October 2023. You should share your embedded emissions data with importers as soon as this is possible after the end of each quarter.

## Importers

During the transitional period, the reporting period for importers (“reporting declarants”) is quarterly, with reports due within one month.

- The first quarterly report is for the period October to December 2023, with the report due to be submitted on the CBAM Transitional Registry by 31 January 2024.
- The last quarterly report is for the period October to December 2025, with the report due to be submitted on the CBAM Transitional Registry by 31 January 2026.

The quarterly report should summarise the embedded emissions in goods imported during the previous quarter of the calendar year, splitting out direct and indirect emissions, as well

---

<sup>23</sup> This will be the most frequent case, except where an eligible MRV system is already in place.

as any carbon price due outside the EU. For deciding at what date a good was imported, the “**release to the market**” (i.e. the clearance by the customs authorities) is relevant. This is important in particular for goods put under the “**inward processing**” procedure (see section 4.3.5).

Note that a CBAM report which has already been submitted may still be corrected<sup>24</sup> until two months after the end of the reporting quarter. This may be the case, for example, when more accurate data on embedded emissions becomes available to the importer after the reporting deadline. Acknowledging the difficulty to set up MRV systems in time, the Implementing Regulation allows a longer period for corrections for the first two quarterly reports, which is until the deadline for the third quarterly report. This means that the reports due by 31 January and 30 April 2024 may be subsequently corrected until 31 July 2024.

#### 4.3.4 Governance of the CBAM

Figure 4-1: Overview of the reporting responsibilities in the transitional period of the CBAM.

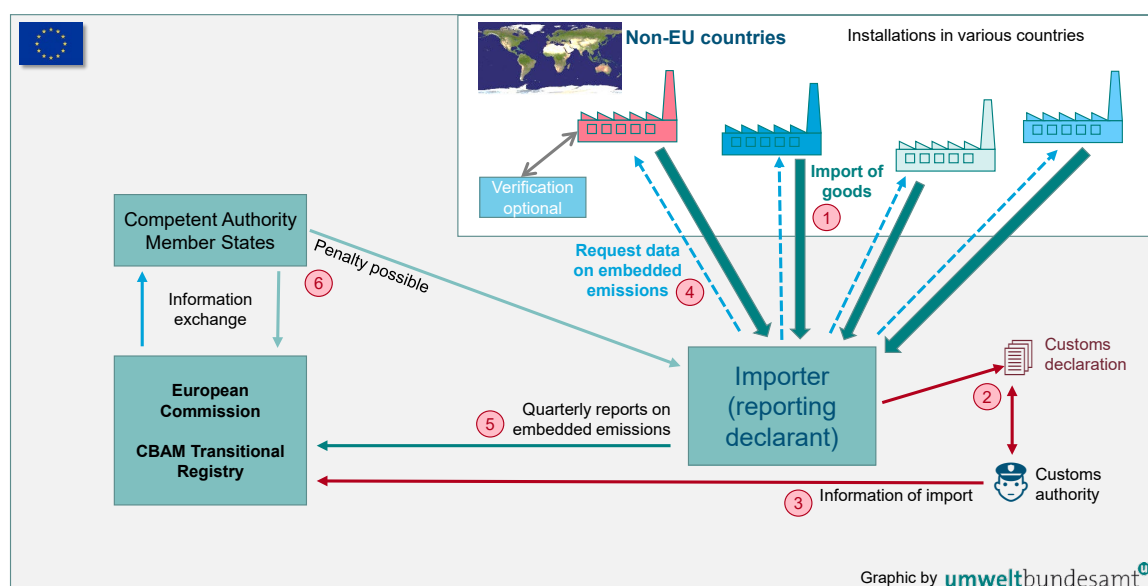

For explanation of the numbers (relating to the workflow), please see main text below.

As shown schematically in Figure 4-1, the governance system and workflows in the transitional period of the CBAM follow the steps below (paragraph numbering follows the red numbers in the figure):

1. The importer (reporting declarant) receives CBAM goods from various installations, possibly from different countries outside the EU.
2. For each import, the importer lodges the usual customs declaration. The customs authority of the relevant EU Member State checks and clears the import, as usual.

<sup>24</sup> Article 9 of the Implementing Regulation

3. The customs authority (or the IT system used) informs the European Commission (using the CBAM Transitional Registry) of this import. This information can then be used to check the completeness and accuracy of quarterly CBAM reports.
4. The reporting declarant requests the relevant data on specific embedded emissions of the imported CBAM goods from the operators (in practice, this may involve intermediary traders, who would have to forward the request to the operator of the installation which produced the CBAM goods). The latter reply by sending the requested data, if possible, using the template provided for this purpose by the Commission. The data may be voluntarily verified by a third-party verifier.
5. The reporting declarant is then able to submit the quarterly CBAM report to the CBAM Transitional Registry.
6. An information exchange between the Commission and the competent authorities in the EU Member States takes place. The Commission informs (based on the customs data), which reporting declarants are expected to submit CBAM reports. Furthermore, the Commission can perform spot checks of actual reports and check their completeness with regards to the customs data. Where irregularities are identified, the Commission informs the competent authority of this. The competent authority will then follow up, usually by getting in contact with the importer and requesting rectification of the irregularity, or submission of the missing CBAM report. If the reporting declarant does not correct the mistakes, the competent authority can ultimately impose a (financial) penalty.
7. (Not shown in the figure and not required by legislation, but in the own interest of the importer): to avoid similar problems in the future, the importer who received a penalty should inform the operator of the problem(s) identified by the Commission or the competent authority in order to address the issue(s) for future submissions.

#### **4.3.5 Inward processing**

The Union Customs Code defines several special procedures. “Inward processing”<sup>25</sup> means that a good is imported into the EU for processing with suspension of import duties and VAT. After the processing operations, the processed products or the original imported goods can then be either re-exported or released for free circulation in the EU. The latter would imply the obligation to pay import duty and taxes, as well as the application of commercial policy measures.

This principle is extended to the CBAM, i.e. no obligation for reporting under the CBAM arises in this case. However, if the CBAM good is released to the EU market after inward processing, either as the original good or modified, a CBAM reporting obligation arises.

For goods actually imported after having been put under inward processing, the period under which they must be included in the CBAM report starts on the date of release to the internal market (discharge from the customs procedures). For this reason, in some cases goods may have to be reported under the CBAM although they were put under inward processing before 1 October 2023.

---

<sup>25</sup> [https://taxation-customs.ec.europa.eu/customs-4/customs-procedures-import-and-export-0/what-importation/inward-processing\\_en](https://taxation-customs.ec.europa.eu/customs-4/customs-procedures-import-and-export-0/what-importation/inward-processing_en)

Article 6 of the Implementing Regulation provides some special reporting requirements for goods released for free circulation after inward processing for the purposes of the quarterly CBAM reports:

- If the good was not modified during the inward processing, the quantities of the good and the embedded emissions of those quantities put under inward processing are to be reported. The report shall also include the country of origin and the installations where the goods were produced, if those are known;
- If the good was modified, the quantities of the original good and the embedded emissions of those quantities put under inward processing are to be reported. The report shall also include the country of origin and the installations where the goods were produced, if those are known;
- Where the origin of the good used for inward processing cannot be defined, the embedded emissions shall be calculated on the basis of the weighted average embedded emissions of the totality of the goods placed under the inward processing procedure for the same aggregated good category.

## 5 CBAM GOODS AND PRODUCTION ROUTES

This section provides guidance on industry sector specific rules that apply for the transitional period, for the cement, hydrogen, fertilizers, iron and steel and aluminium sectors. It deals with the specification of products covered by the CBAM and the relevant production routes. Section 6 explains the monitoring requirements of the CBAM which apply to all sectors. Thereafter, section 7 continues with sector-specific details, in particular by adding sector-specific monitoring and reporting requirements, and by providing elaborated examples for each sector.

While this guidance document is intended primarily for use by operators who produce tangible goods falling under the CBAM, section 7 contains also some information for importers of electricity as a good, under the CBAM (section 7.6).

### 5.1 Foreword to sector specific sections

The following sections provide an overview of the different production routes for the goods listed in Annex I to the CBAM Regulation and provide sector specific guidance.

Additional information on the production processes of the goods can also be found in the BREF<sup>26</sup> reference documents for best available techniques (BAT).

#### **Diagrams used in the following sections.**

**For the system boundary graphics** presented in the sections below, the **following conventions** are applied:

- Production processes (for which monitoring of the direct emissions would take place) are shown as rectangles; Materials are shown in boxes with rounded corners.
- Optional processes (e.g. CCS/CCU) are shown in blue boxes. In particular, CCS/CCU would not be taken into account for developing default values, but where you (as an operator) use them, the related emissions or emission savings should be taken into account for determining actual embedded emissions.
- Materials which are considered to have no embedded emissions are shown in red boxes, materials with embedded emissions (relevant precursor materials and final products, i.e. goods under the CBAM) in green boxes. Simple goods are shown in normal font, complex goods in bold font.
- Input materials are presented without trying to be complete. This means that the focus is on materials which are relevant for demonstrating the differences between different production routes. As a consequence, less important input materials and in particular fuels are usually omitted in order to keep graphs simple.

<sup>26</sup> BAT Reference document (BREF), BAT being “Best Available Techniques” as defined by the IED (Industrial Emissions Directive). Relevant BREF documents are those for: the production of cement; for iron and steel production; large volume inorganic chemicals (which includes fertilizers); for Chlor-alkali; and for non-ferrous metals (which includes both aluminium and ferro-alloys). All BREFs can be found at the European IPPC Bureau, under <https://eippcb.jrc.ec.europa.eu/reference>.

- Note: CCS/CCU processes are indicated in the following Figure 5-1 for the cement value chain as an example. To keep the graphics reasonably simple, this is not shown in other sectors, but is equally applicable.

Electricity as input is shown only in cases where it is the main “precursor” of the process (i.e. in particular for electric arc furnaces and electrolysis processes).

## 5.2 Identifying CBAM goods

This section explains how goods covered by the CBAM are defined and identified in the Regulation. The textbox below signposts the key sections for the definition and reporting of CBAM goods, relevant for the CBAM transitional period.

---

### *Implementing Regulation references:*

**Annex II**, Section 2, Table 1 Mapping of CN codes to Aggregated goods categories.

**Annex III**, Section F Rules for attributing emissions of an installation to goods.

---

### 5.2.1 *Product specifications*

The Combined Nomenclature (CN)<sup>27,28</sup> classification system defines the essential characteristics of goods and is used to identify those sector goods in scope for the CBAM.

The CN ‘product specification’ classification system comprises two parts, firstly a numerical 4, 6 or 8-digit numbering system, reflecting different levels of product disaggregation, and secondly a short text description of each product category giving its essential characteristics. The first 6 digits are identical to the Harmonised System (HS) classification used in international trade and the remaining 2 digits are EU-specific additions.

Both parts of the goods’ product specification are given in Annex I to the CBAM Regulation, but elsewhere in the text this may also be abridged to the numerical code only, for ease of reference.

### 5.2.2 *Identifying goods in scope for the CBAM Regulation*

You (as an operator) should first establish which goods produced by your installation fall under the scope of the CBAM. To this end, you should:

- Draw up a list of all goods and precursors at your installation, both produced at your installation and precursors obtained from outside the installation.

---

<sup>27</sup> Council Regulation (EEC) No 2658/87 of 23 July 1987 on the tariff and statistical nomenclature and on the Common Customs Tariff (OJ L 256, 7.9.1987, p. 1).

<sup>28</sup> For further information on the CN definitions for goods see the Eurostat RAMON database for 2022 at: [https://ec.europa.eu/eurostat/ramon/nomenclatures/index.cfm?TargetUrl=LST\\_NOM\\_DTL&StrNom=CN\\_2022](https://ec.europa.eu/eurostat/ramon/nomenclatures/index.cfm?TargetUrl=LST_NOM_DTL&StrNom=CN_2022)

*Note that it is possible for the same goods category to be applicable to both the good produced and for the precursor used to produce that good. This is relevant for iron and steel, aluminium and fertilizer sector goods.*

- Check and compare the full range of goods produced against the product specifications given in Annex I to the CBAM Regulation.
- From this comparison, establish which of the listed goods produced by the installation are within the scope of the CBAM.

### 5.3 Cement sector

The textbox below signposts sector-specific sections in the Implementing Regulation, relevant for the CBAM transitional period.

---

**Implementing Regulation references:**

- **Annex II**, Section 2, Table 1 Mapping of CN codes to aggregated goods categories.
  - **Annex II**, Section 3 Production routes, system boundaries, and relevant precursors, as specified in sub-sections: 3.2 – Calcined clay, 3.3 – Cement clinker, 3.4 – Cement and 3.5 – Aluminous cement.
- 

#### 5.3.1 Unit of production and embedded emissions for industry sector

The quantity of declared cement goods imported into the EU should be expressed in metric tonnes. You should record the quantity of CBAM good(s) produced by the installation or production process(s), for the purposes of reporting.

<b>Industrial sector</b>	Cement
<b>Production unit of goods</b>	Tonnes (metric), reported separately for each type of CBAM good produced, by the installation or production process in the country of origin.
<b>Associated activities</b>	Producing cement clinkers and calcined clays, grinding and blending cement clinker to produce cement.
<b>Relevant greenhouse gas emissions</b>	Carbon dioxide (CO <sub>2</sub> )
<b>Direct Emissions</b>	Tonnes (metric) of CO <sub>2</sub> e
<b>Indirect Emissions</b>	Quantity of electricity consumed (MWh), source and emissions factor used to calculate the indirect emissions in tonnes (metric) of CO <sub>2</sub> or CO <sub>2</sub> e. <i>To be reported separately during transitional period.</i>
<b>Unit for embedded emissions</b>	Tonnes CO <sub>2</sub> e emissions per tonne of good, reported separately for each type of CBAM good, by the installation or production process in the country of origin.

---

The cement sector has to account for both direct emissions and indirect emissions, in the transitional period. Indirect emissions are to be reported separately. Emissions should be reported in metric tonnes of CO<sub>2</sub> equivalent (tCO<sub>2</sub>e) emissions, per tonne of good output. This figure should be calculated for the specific installation or production process in your country of origin.

Note that a **case study** showing how direct and indirect specific embedded emissions (SEE) values are derived for the **cement production process**, and how the embedded emissions of imports into the EU are calculated, is given in section 7.1.3.

The following sections set out how the system boundaries of cement sector goods should be defined and identify elements of the production processes that should be included for the purposes of monitoring and reporting.

### 5.3.2 Definition and explanation of goods covered

The following Table 5-1 lists the relevant goods in scope for the CBAM transitional period in the cement industry sector. The aggregated goods category in the left hand column defines groups for which joint ‘production processes’ are to be defined for the purpose of monitoring.

Table 5-1: CBAM goods in the cement sector

<b>Aggregated goods category</b>	<b>CN Code</b>	<b>Description</b>
<b>Calcined clay</b>	2507 00 80	Other kaolinic clays
<b>Cement clinker</b>	2523 10 00	Cement clinkers <sup>29</sup>
<b>Cement</b>	2523 21 00	White Portland cement, whether or not artificially coloured
	2523 29 00	Other Portland cement
	2523 90 00	Other hydraulic cements
<b>Aluminous cement</b>	2523 30 00	Aluminous cement <sup>30</sup>

Source: The CBAM Regulation, Annex I; Implementing Regulation, Annex II.

The aggregated goods categories listed in Table 5-1 include both finished cement goods and precursor goods (intermediate products) that are consumed in the production of cement.

Only input materials listed as relevant precursors to the system boundaries of the production process as specified in the Implementing Regulation are to be considered. Table 5-2 lists the precursors by aggregated goods category and production route.

<sup>29</sup> No distinction is made between different types of clinker, i.e. grey and white cement clinker are the same for the purposes of the CBAM.

<sup>30</sup> Also referred to as ‘Calcium Aluminate Cement’.



Table 5-2: Aggregated goods categories, their production routes and relevant precursors

<b>Aggregated Goods Category</b>	<b>Relevant precursors</b>
<i>Production route</i>	
Calcined clay	None
Cement clinker	None
Cement	Cement clinker; calcined clay (if used in the process).
Aluminous cement	None

Precursor goods relevant to the system boundary are ‘cement clinker<sup>31</sup>’ (CN code 2523 10 00), which includes both white clinker (used to make white cement) and grey clinker, and ‘calcined clay’ (CN code 2507 00 80)<sup>32</sup>, which is a clinker substitute and may be used to modify the properties of the cement produced.

These precursors are defined as simple goods, as the raw material constituents and fuels (both fossil fuels and any alternative fuels) used in their manufacture are themselves considered to have zero embedded emissions.

The finished cement goods listed in Table 5-1 comprise both white Portland cement, grey Portland cement, other hydraulic cements and aluminous cement. These goods are defined as complex goods (with the exception of aluminous cement) as they include the embedded emissions from precursor goods.

Other constituents used in cement manufacture, in particular granulated blast furnace slag, fly ash and natural pozzolana that are used in the manufacture of other hydraulic cement goods (including blended or ‘composite’ cements) are not considered to have any embedded emissions and are not in scope for the CBAM.

Cement sector goods are produced by a number of different process routes, outlined below.

### **5.3.3 Definition and explanation of relevant production processes and routes**

The system boundaries of precursors and cement goods are distinct and may, under certain conditions, be added together to include all processes directly or indirectly linked to the production processes for these goods, including input activities to the process and output activities from the process.

The relevant emissions that should be monitored for the cement sector are detailed in section 7.1.1.

<sup>31</sup> No distinction is made between grey and white clinker, the operator should apply the relevant embodied emissions of the relevant clinker precursor used.

<sup>32</sup> The CN code includes non-calcined clays too, which are not subject to the CBAM; in this case, the quantities of non-calcined clay imported are still reported, but with zero embedded emissions and without monitoring requirements for the producer.

### 5.3.3.1 Calcined clay production process

Calcined clay may be used as a clinker substitute. Kaolinic clay that is calcined (metakaolin) can be added to cement in place of clinker in varying proportions in order to modify the properties of the cement mixture.

The Implementing Regulation (section 3 Annex II) defines the system boundaries for direct emissions monitoring of the calcined clay production route, as encompassing:

*“ – All processes directly or indirectly linked to the production processes, such as raw material preparation, mixing, drying, and calcining, and flue gas cleaning.  
– CO<sub>2</sub> emissions from the combustion of fuels as well as from raw materials, where relevant.”*

There are no relevant precursors for this production process. Indirect emissions that result from electricity consumed by the production process should also be monitored.

Note that other clays falling under CN code 2507 00 80 which are not calcined are assigned embedded emissions of zero.

### 5.3.3.2 Cement clinker production process

Cement clinker is produced in clinker plants (kilns) by the thermal decomposition of calcium carbonate to form calcium oxide, followed by the clinkering process in which the calcium oxide reacts at high temperatures with silica, alumina and ferrous oxide to form a clinker. Grey and white clinkers may be produced depending on the temperature of the process and purity of raw materials.

The Implementing Regulation (section 3 Annex II) defines the system boundaries for direct emissions monitoring of the cement clinker production route, as encompassing:

*“ – Calcination of limestone and other carbonates in the raw materials, conventional fossil kiln fuels, alternative fossil-based kiln fuels and raw materials, biomass kiln fuels (such as waste-derived fuels), non-kiln fuels, non-carbonate carbon content of limestone and shales, or alternative raw materials such as fly ash used in the raw meal in the kiln and raw materials used for flue gas scrubbing.”*

There are no relevant precursors for this production process. Indirect emissions that result from electricity consumed by the production process should also be monitored.

In line with the above definition of system boundaries, the following production steps may be regarded as being within the system boundaries of cement clinker installations:

- Raw material preparation – grinding, milling, homogenisation.
- Fuel storage and preparation – for conventional and waste derived fuels.
- Clinker production (‘clinker burning’) – all steps for the integrated kiln system including preheating, kiln processing and clinker cooling.

- Intermediate storage – storage of cement clinker under cover before export off site or cement grinding.
- Emissions control – for treating releases to air, water or ground.

The methods for calculating process emissions from carbonate materials on either an input or output basis are given in section 6.5.1.1 of this guidance document.

An additional rule on the treatment of cement kiln dust (CKD) is given section 7.1.1.2, and a **case study** showing how the specific embedded emissions of cement clinker are derived is given in section 7.1.2.

### 5.3.3.3 *Cement production process*

Cement (apart from aluminous cement) is defined as a complex good as it is produced from relevant precursors cement clinker and possibly calcined clay.

Cement is produced in a grinding plant (cement mill), which may be located at the same installation that produced the cement clinker, or at a separate standalone plant. Cement clinker is ground and blended with certain other constituents to produce the finished cement product. Depending on the mix of different constituents this may be Portland cement, blended cement (containing a mix of Portland cement and other hydraulic constituents) or other hydraulic cements.

The Implementing Regulation (section 3 Annex II) defines the system boundaries for direct emissions monitoring of the cement production route, as encompassing:

*“ – All CO<sub>2</sub> emissions from fuel combustion, where relevant for drying of materials.”*

Relevant precursors are cement clinker and calcined clay (if used in the process). Indirect emissions that result from electricity consumed by the production process should also be monitored.

In line with the above definition of system boundaries, the following production steps may be regarded as being within the system boundaries of cement installations:

- Material preparation – materials (cement clinker, calcined clay and mineral additives) handling and pre-treatment e.g. preheating and drying mineral additives.
- Cement production – all steps, including crushing, grinding, further milling and separation by particle size.
- Cement storage, packaging and dispatch.
- Emissions control – for treating releases to air, water or ground.

Figure 5-1 following shows how the cement clinker and cement production processes relate to each other.

Figure 5-1: System boundaries of cement clinker and cement production processes.

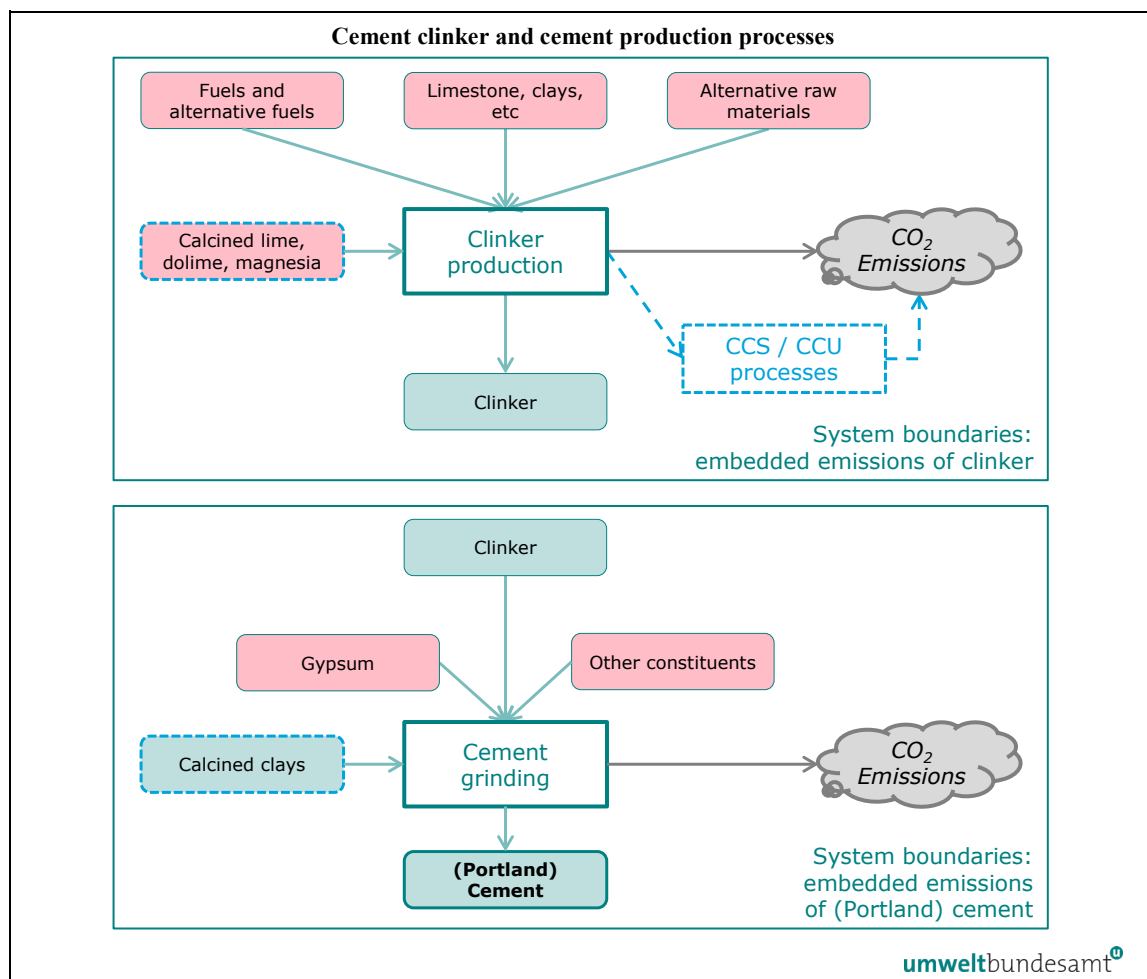

Direct emissions of the cement clinker production process result from the combustion of both kiln and non-kiln fuels and from raw materials used in the process such as limestone. Direct emissions may also result from fuels used for drying materials used to make the final cement product.

A variation on the clinker production process may be with permanent geological storage i.e. carbon capture and sequestration (CCS).

Note that no distinction is made between grey and white cement clinker used in the production of cement goods.

#### 5.3.3.4 Aluminous cement production process

Aluminous cement is regarded as a simple good as it is produced directly from aluminous clinker by a continuous production process, and is ground without the addition of further additives.

The Implementing Regulation (section 3 Annex II) defines the system boundaries for direct emissions monitoring of the aluminous cement production route, as encompassing:

“ – All CO<sub>2</sub> emissions from fuel combustion directly or indirectly linked to the process.

– Process emissions from carbonates in raw materials, if applicable, and flue gas cleaning.”

There are no relevant precursors for this production process. Indirect emissions that result from electricity consumed by the production process should also be monitored.

In line with the above definition of systems boundaries, the integrated production of aluminous cement includes both clinkering and cement grinding production steps, from raw material preparation through to emissions control.

Figure 5-2: System boundaries of the aluminous cement production process

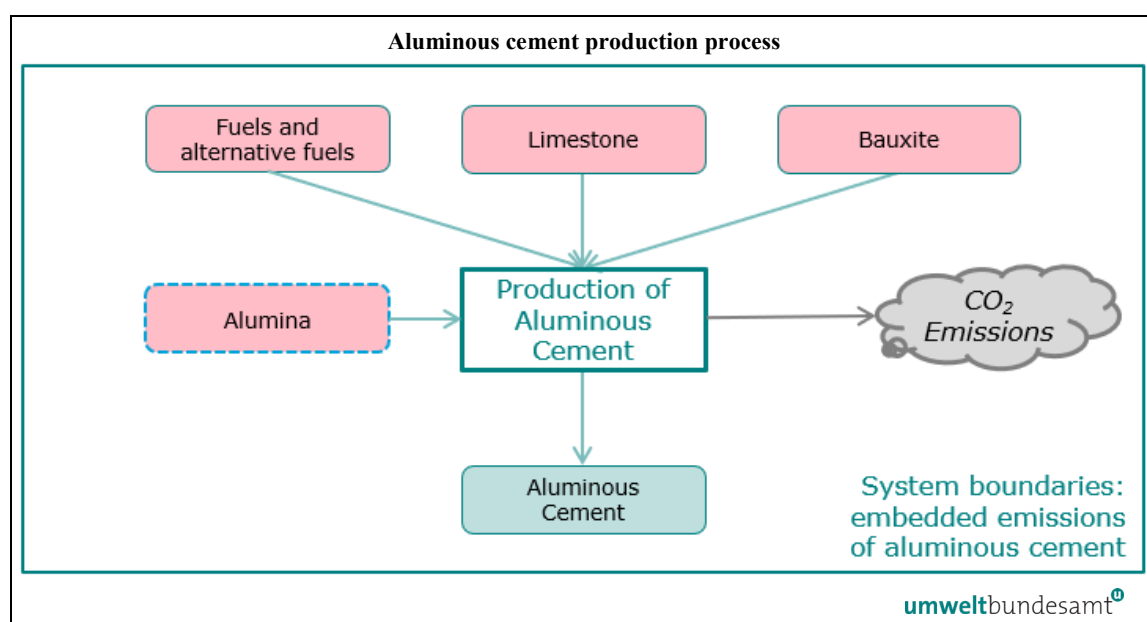

Note that alumina (produced from bauxite) is treated as a raw material and has zero embedded emissions.

## 5.4 Chemicals sector – Hydrogen

The textbox below signposts sector-specific sections in the Implementing Regulation, relevant for the CBAM transitional period.

---

### Implementing Regulation references:

- **Annex II**, Section 2, Table 1 Mapping of CN codes to aggregated goods categories.
  - **Annex II**, Section 3 Production routes, system boundaries, and relevant precursors, as specified in sub-section: 3.6 – Hydrogen, including additional rules for the attribution of emissions in sub-section 3.6.2.2 Electrolysis of water and sub-section 3.6.2.3 Chlor-Alkali electrolysis.
- 



### 5.4.1 Unit of production and embedded emissions

The quantity of hydrogen imported into the EU should be expressed in metric tonnes (as pure hydrogen). As an operator, you should record the quantity of hydrogen produced by installation or production process, for the purposes of reporting.

<b>Industrial sector</b>	<b>Chemicals – Hydrogen</b>
<b>Production unit of goods</b>	Tonnes (metric) pure hydrogen, reported separately by installation or production process in the country of origin
<b>Associated activities</b>	Producing hydrogen by steam reforming or partial oxidation of hydrocarbons, water electrolysis, Chlor-Alkali electrolysis or production of sodium chlorate.
<b>Relevant greenhouse gases</b>	Carbon dioxide (CO <sub>2</sub> )
<b>Direct Emissions</b>	Tonnes (metric) of CO <sub>2</sub> e
<b>Indirect Emissions</b>	Quantity of electricity consumed (MWh), source and emissions factor used to calculate the indirect emissions in Tonnes (metric) of CO <sub>2</sub> or CO <sub>2</sub> e.  <i>To be reported separately during transitional period.</i>
<b>Unit for embedded emissions</b>	Tonnes CO <sub>2</sub> e emissions per tonne of good, reported separately for each type of good, by installation in the country of origin

The hydrogen sector has to account for both direct emissions and indirect emissions in the transitional period. Indirect emissions are to be reported separately<sup>33</sup>. Emissions should be reported in metric tonnes CO<sub>2</sub> equivalent (tCO<sub>2</sub>e) emissions per tonne of output. This figure should be calculated for the specific installation or production process in your country of origin.

Note that several **case studies** showing how direct and indirect specific embedded emissions (SEE) values are derived, for hydrogen produced by the **steam reforming** and **Chlor-Alkali production routes**, and how the embedded emissions of imports into the EU are calculated, is given in section 7.5.2.

The following sections set out how the system boundaries of different hydrogen production routes should be defined, and identify elements of the production process that should be included for the purposes of monitoring and reporting.

### 5.4.2 Definition and explanation of sector CBAM goods covered

The following Table 5-3 lists the relevant goods in scope for the CBAM transitional period in the hydrogen industry sector. The aggregated goods category in the left hand column

<sup>33</sup> Note that for this sector indirect emissions are only reported during the transitional period (and not during the definitive period).

defines groups for which joint ‘production processes’ are to be defined for the purpose of monitoring.

Table 5-3: CBAM goods in the chemicals sector – hydrogen

Aggregated goods category	Product CN Code	Description
Hydrogen	2804 10 000	Hydrogen

Source: The CBAM Regulation, Annex I; Implementing Regulation, Annex II.

Hydrogen is defined as simple good, as the raw materials and fuels used in its manufacture are considered to have zero embedded emissions.

There are **no relevant precursors** for hydrogen. However, hydrogen may itself be a relevant precursor for other processes, where it is separately produced for use as a chemical feedstock to produce ammonia, or to produce pig iron or direct reduced iron (DRI).

The production of hydrogen is by a number of different process routes, outlined below.

### 5.4.3 Definition and explanation of relevant production processes and routes

Hydrogen can be produced from various feedstocks including plastic wastes, but currently it is derived mostly from fossil fuels. Hydrogen production units are typically integrated into larger industrial processes e.g. as for an installation producing ammonia.

Figure 5-3: System boundaries of different production routes for hydrogen – overview

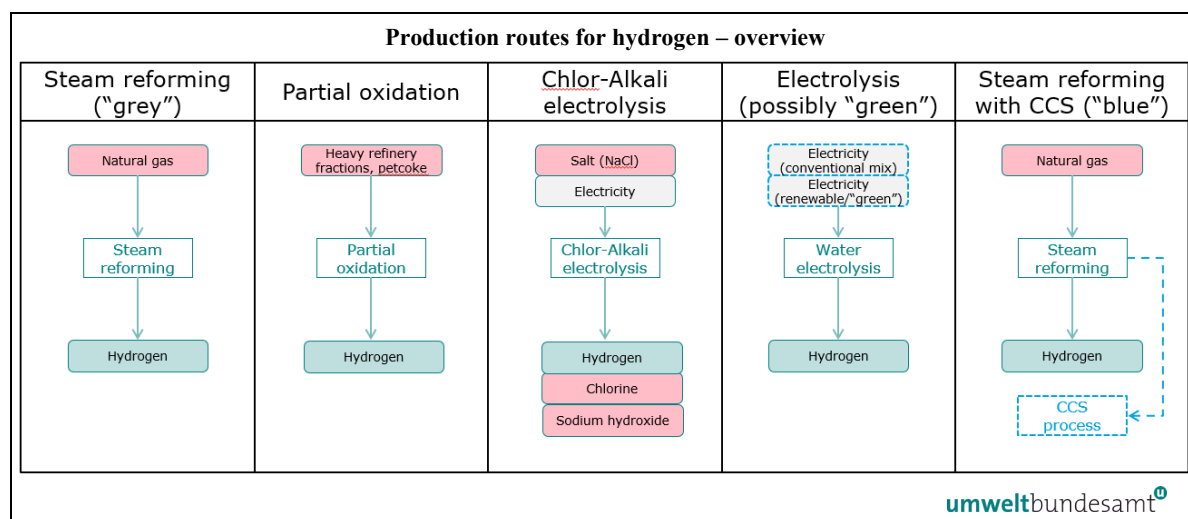

The system boundaries for direct emissions monitoring for hydrogen include all processes directly or indirectly linked to hydrogen production, and all fuels used in the production of hydrogen.

The relevant emissions that should be monitored for the hydrogen sector are detailed in section 7.5.1.1.

Note that only the production of pure hydrogen or mixtures of hydrogen with nitrogen usable in ammonia production shall be considered. Not covered are the production of

synthesis gas or of hydrogen within refineries or organic chemical installations, where the hydrogen is exclusively used within those plants and not used for the production of goods under the CBAM Regulation.

#### 5.4.3.1 *Hydrogen – Steam reforming production route*

The natural gas feedstock for this process is converted to carbon dioxide and hydrogen through primary and secondary steam reformation. The overall reaction is highly endothermic and process heat is supplied by the combustion of natural gas or other gaseous fuel. Carbon monoxide produced is almost all converted to carbon dioxide by the process.

The Implementing Regulation (section 3 Annex II) defines the system boundaries for direct emissions monitoring for the steam reforming (or partial oxidation) production routes, as encompassing:

*“ – All processes directly or indirectly linked to hydrogen production, and flue gas cleaning.*

*– All fuels used in the hydrogen production process irrespective of their energetic or non-energetic use, and fuels used for other combustion processes including for the purpose of producing hot water or steam.”*

There are no relevant precursors for this production process. Indirect emissions that result from electricity consumed by the production process should also be monitored.

In line with the above definition of systems boundaries, the following production steps may be regarded as being within the system boundaries of a hydrogen (steam reformation) installation:

- Raw material pre-treatment – natural gas desulphurisation
- Steam reformation – primary and secondary, H<sub>2</sub>/CO generation
- Shift conversion – carbon monoxide to carbon dioxide and hydrogen
- Separation & purification – CO<sub>2</sub> removal, separation processes as present including cryogenic, adsorption, absorption, membrane, hydrogenation (methanation)
- Emissions control – for treating releases to air, water or ground

The stream of carbon dioxide produced by the steam reforming process is very pure and is separated and captured for further use, e.g. for urea production. A variation on this process may be with permanent geological storage i.e. carbon capture and sequestration (CCS).

A worked example for the calculation of specific embedded emissions for hydrogen produced by the steam reforming production route is given in section 7.5.2.1.

#### 5.4.3.2 *Hydrogen – Partial oxidation of hydrocarbons (gasification) production route*

Hydrogen is produced by the partial oxidation (gasification) of hydrocarbons, typically from heavy feedstocks such as residual heavy oils or coal and even waste plastics. Carbon monoxide produced by the process is almost all converted to carbon dioxide.



The Implementing Regulation (section 3 Annex II) defines the system boundaries for direct emissions monitoring for the partial oxidation (or steam reforming) production routes, as encompassing:

*“ – All processes directly or indirectly linked to hydrogen production, and flue gas cleaning.*

*– All fuels used in the hydrogen production process irrespective of their energetic or non-energetic use, and fuels used for other combustion processes including for the purpose of producing hot water or steam.”*

There are no relevant precursors for this production process. Indirect emissions that result from electricity consumed by the production process should also be monitored.

In line with the above definition of systems boundaries, the following production steps may be regarded as being within the system boundaries of a hydrogen (partial oxidation) installation:

- Air separation unit – to produce the oxygen for the partial oxidation step.
- Gasification – H<sub>2</sub>/CO generation.
- Synthesis gas clean up – soot and sulphur removal.
- Shift conversion – carbon monoxide to carbon dioxide.
- Separation & purification – CO<sub>2</sub> removal, separation processes including cryogenic separation (liquid nitrogen).
- Emissions control – for treating releases to air, water or ground.

The stream of carbon dioxide produced from the process is of high purity and may be separated and captured for further use.

#### 5.4.3.3 *Hydrogen – Electrolysis of water production route*

Water electrolysis is a standalone, non-integrated production process that produces a very pure stream of hydrogen gas. Direct emissions from this process are minimal. Indirect emissions result from electricity consumed by the process. Hydrogen produced by renewable electricity may become relevant in the future.

The Implementing Regulation (section 3 Annex II) defines the system boundaries for direct emissions monitoring the electrolysis of water production route, as encompassing if relevant:

*“ – All emissions from fuel use directly or indirectly linked to the hydrogen production process and from flue gas cleaning.”*

There are no relevant precursors for this production process.

Indirect emissions that result from electricity consumed by the production process also need to be monitored. Note that where the produced hydrogen has been certified to comply with Commission Delegated Regulations (EU) 2023/1184 (1), an emission factor of zero

for the electricity may be used. In all other cases, the rules on indirect embedded emissions (Section D of Annex III) shall apply).

An additional rule giving the method for attributing emissions to hydrogen produced by the electrolysis of water is provided in section 7.5.1.2.

#### 5.4.3.4 *Hydrogen – Chlor-alkali electrolysis (and production of chlorates) production routes*

Hydrogen is produced as a by-product of the electrolysis of brine, alongside the simultaneous production of chlorine and sodium hydroxide. There are three basic chlor-alkali process techniques: mercury cell, diaphragm cell and the membrane cell. All three cell techniques produce hydrogen, which is formed at the cell cathode and which leaves the cell at very high purity. The hydrogen gas produced is cooled, dried and purified to remove water vapour, and other impurities, which may in some cases include oxygen, and is then compressed and stored or exported off site.

The Implementing Regulation (section 3 Annex II) defines the system boundaries for direct emissions monitoring for the chlor-alkali and production of chlorates production routes, as encompassing if relevant:

*“ – All emissions from fuel use directly or indirectly linked to the hydrogen production process and from flue gas cleaning.”*

There are no relevant precursors for this production process.

Indirect emissions that result from electricity consumed by the production process also need to be monitored. Note that where the produced hydrogen has been certified to comply with Commission Delegated Regulations (EU) 2023/1184 (1), an emission factor of zero for the electricity may be used. In all other cases, the rules on indirect embedded emissions (Section D of Annex III) shall apply).

In line with the above definition of systems boundaries, the following production steps may be regarded as being within the system boundaries of a hydrogen (chlor-alkali) installation:

- Electrolysis of brine – brine preparation, electrolysis, generation of hydrogen as a by-product and collection.
- Gas cooling, drying and purification – removal of water vapour, sodium hydroxide, salt, chlorine and oxygen from hydrogen gas.

An additional rule for the method for attributing emissions to hydrogen produced by the chlor-alkali process is provided in section 7.5.1.2 and a worked example is given in section 7.5.2.2.

## 5.5 Fertilizers sector

The textbox below signposts sector-specific sections in the Implementing Regulation, relevant for the CBAM transitional period.

---

**Implementing Regulation references:**

- **Annex II** Section 2, Table 1 Mapping of CN codes to aggregated goods categories.
  - **Annex II:** Section 3 Production routes, system boundaries, and relevant precursors, as specified in sub-sections: 3.7 – Ammonia; 3.8 – Nitric acid; 3.9 – Urea; 3.10 – Mixed fertilizers.
- 

**5.5.1 Unit of production and embedded emissions**

The quantity of declared nitrogen containing fertilizer sector goods imported into the EU should be expressed in metric tonnes. As an operator, you should record the quantity of CBAM goods produced by installation or production process, for the purposes of reporting.

---

<b>Industrial sector</b>	<b>Fertilizers</b>
<b>Production unit of goods</b>	Tonnes (metric) <sup>34</sup> , reported separately for each type of sector goods, by installation or production process in the country of origin
<b>Associated activities</b>	Producing chemical precursors for nitrogenous fertilizer production, producing nitrogenous fertilizers by physical mixing or chemical reaction, and processing into their final form.
<b>Relevant greenhouse gas emissions</b>	Carbon dioxide (CO <sub>2</sub> ) and nitrous oxide (N <sub>2</sub> O)
<b>Direct Emissions</b>	Tonnes (metric) of CO <sub>2</sub> e
<b>Indirect emissions</b>	Quantity of electricity consumed (MWh), source and emissions factor used to calculate the indirect emissions in Tonnes (metric) of CO <sub>2</sub> or CO <sub>2</sub> e.  <i>To be reported separately during transitional period.</i>
<b>Unit for embedded emissions</b>	Tonnes CO <sub>2</sub> e emissions per tonne of goods, reported separately for each type of goods, by installation in the country of origin

---

The fertilizer industry sector has to account for both direct emissions and indirect emissions in the transitional period. Indirect emissions are to be reported separately. Emissions should be reported in metric tonnes CO<sub>2</sub> equivalent (tCO<sub>2</sub>e) emissions per tonne of output. This figure should be calculated for the specific installation or production process in your country of origin.

---

<sup>34</sup> For certain goods, the imported quantities need to be converted to standardised tonnes that are subsequently used for calculating the CBAM obligation. For example, for nitric acid, hydrous solutions of ammonia and nitrogen-containing fertilizers, there will be a need to explicitly state the reference concentration / nitrogen content (and form of nitrogen).

Note that a **case study** showing how direct and indirect specific embedded emissions (SEE) values are derived for the **mixed fertilizer production process**, and how the embedded emissions of imports into the EU are calculated, is given in section 7.3.2.

The following sections set out how the system boundaries of fertilizer sector goods should be defined, and identify elements of the production process that should be included for the purposes of monitoring and reporting.

### 5.5.2 Definition and explanation of sector CBAM goods covered

The following Table 5-4 lists the relevant goods in scope for the CBAM transitional period in the fertilizer industry sector. The aggregated goods category in the left hand column defines groups for which joint ‘production processes’ are to be defined for the purpose of monitoring.

Table 5-4: CBAM goods in the fertilizer sector

Aggregated goods category	Product CN Code	Description
Nitric acid	2808 00 00	Nitric acid; sulphonitric acids
Urea	3102 10	Urea, whether or not in aqueous solution
Ammonia	2814	Ammonia, anhydrous or in aqueous solution
Mixed fertilizers	2834 21 00, 3102, 3105 - Except 3102 10 (Urea) and 3105 60 00	2834 21 00 – Nitrates of potassium 3102 – Mineral or chemical fertilizers, nitrogenous - Except 3102 10 (Urea) 3105 – Mineral or chemical fertilizers containing two or three of the fertilising elements nitrogen, phosphorus, and potassium; other fertilizers - Except: 3105 60 00 – Mineral or chemical fertilizers containing the two fertilising elements phosphorus and potassium <sup>35</sup>

Source: The CBAM Regulation, Annex I; Implementing Regulation, Annex II.

The aggregated goods categories listed in Table 5-4 include both the finished nitrogenous fertilizer goods and chemical precursor goods (intermediate products) that are consumed in the production of fertilizer.

Only input materials listed as relevant precursors to the system boundaries of the production process as specified in the Implementing Regulation, that are produced for use

<sup>35</sup> Only nitrogen (N) containing fertilizers have significant embedded emissions, therefore their precursors are included in the CBAM.

in chemical fertilizer production, are to be considered<sup>36</sup>. Table 5-5 below lists the possible precursors by aggregated goods category and production route.

*Table 5-5: Aggregated goods categories, their production routes and possibly relevant precursors*

<b>Aggregated Goods Category</b>	<b>Relevant precursors</b>
<i>Production route</i>	
Ammonia <i>Haber Bosch with steam reforming</i> <i>Haber Bosch with gasification</i>	Hydrogen, if separately produced for use in the process <sup>37</sup> .
Nitric Acid	Ammonia (as 100% ammonia).
Urea	Ammonia (as 100% ammonia).
Mixed fertilizer	If used in the process: ammonia (as 100% ammonia), nitric acid (as 100% nitric acid), urea, mixed fertilizers (in particular salts containing ammonium or nitrate).

For the production of mixed fertilizer, not all precursors will apply in every case. Note in particular that in some instances an aggregated goods category (mixed fertilizer itself) may be used as a precursor for its own category, depending on the final formulation of the mixed fertilizer product required.

The final nitrogenous chemical fertilizer goods produced from the relevant precursors (in bulk in integrated plants) are defined as complex goods as they include the embedded emissions from relevant precursor goods.

The production of fertilizer sector goods is by a number of different process routes, outlined below.

### **5.5.3 Definition and explanation of relevant production processes and routes**

The system boundaries of chemical precursors and fertilizers are distinct and may, under certain conditions, be added together to include all processes directly or indirectly linked to the production processes for these goods, including input activities to the process, and output activities from the process.

The following Figure 5-4 provides an overview of the different processes and process routes for the production of nitrogenous fertilizer and its relevant precursors.

<sup>36</sup> Around 80% of all ammonia production is used as a chemical precursor for fertilizer production and circa 97% of nitrogen fertilizers are derived from ammonia.

<sup>37</sup> Where hydrogen from other production routes is added to the process, it shall be treated as a precursor with its own embedded emissions.

Figure 5-4: System boundaries and value chain for the production of nitrogenous fertilizer and its precursors – overview

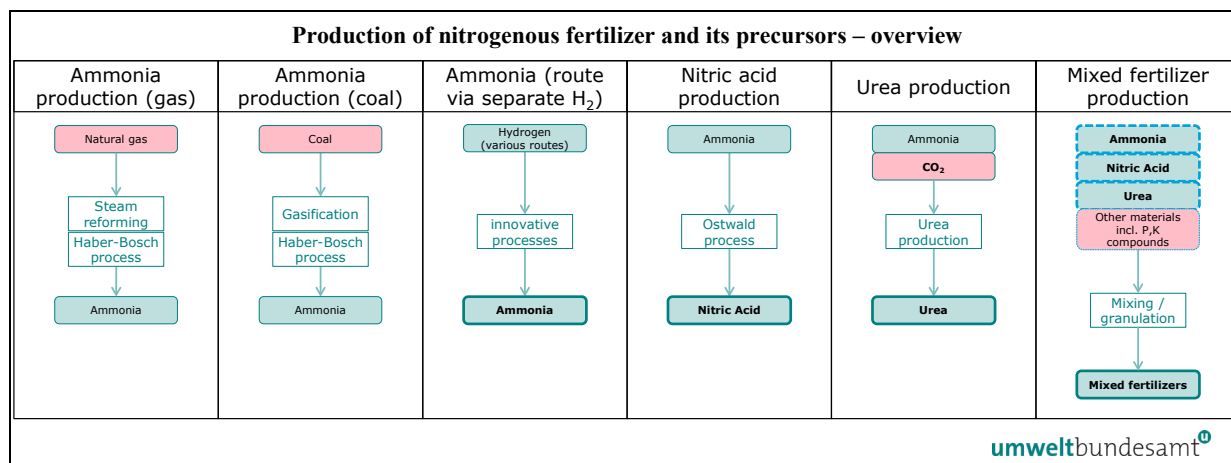

Urea is used as a precursor in mixed fertilizer production but may also be used as a convenient fertilizer on its own due to its high nitrogen content.

Mixed fertilizers comprise all kinds of nitrogen (N) containing fertilizers, including ammonium nitrate, calcium ammonium nitrate, ammonium sulphate, ammonium phosphates, urea ammonium nitrate solutions, as well as nitrogen-phosphorus (NP), nitrogen-potassium (NK) and nitrogen-phosphorus-potassium (NPK) fertilizers.

The relevant emissions that should be monitored for the fertilizers sector are detailed in section 7.3.1.1.

#### 5.5.3.1 Ammonia – Haber-Bosch with steam reforming production route

Ammonia is synthesised from nitrogen and hydrogen via the Haber-Bosch process. Hydrogen for the process is obtained in this production route by steam reforming natural gas (or biogas) whilst nitrogen is obtained from the air. The overall reaction is highly endothermic and process heat is supplied by the combustion of natural gas or other gaseous fuel. Any carbon monoxide produced is almost all converted to carbon dioxide.

The Implementing Regulation (section 3 Annex II) defines the system boundaries for direct emissions monitoring for the Haber-Bosch process with steam reforming production route, as encompassing:

- “ – All fuels directly or indirectly linked to ammonia production, and materials used for flue gas cleaning.
- All fuels shall be monitored, irrespective of whether used as energetic or non-energetic input.
- Where biogas is used, the provisions of Section B.3.3 of Annex III shall be applied.
- Where hydrogen from other production routes is added to the process, it shall be treated as a precursor with its own embedded emissions.”

A relevant precursor is separately produced hydrogen, if used in the process. Indirect emissions that result from electricity consumed by the production process should also be monitored.

In line with the above definition of system boundaries, the following production steps may be regarded as being within the system boundaries of the Haber-Bosch with steam reforming process:

- Production of hydrogen by steam reforming natural gas or biogas<sup>38</sup>.
- Synthesis of ammonia – from hydrogen and nitrogen, at high temperature and pressure in the presence of a catalyst; ammonia condensation, purification and storage (if applicable).
- Emissions control – for treating releases to air, water or ground.

The stream of carbon dioxide from the production of ammonia is of high purity and can be separated, captured and transferred elsewhere for other uses e.g. for urea production.

Note that the ammonia produced is reported as 100% ammonia, whether in hydrous or anhydrous form.

#### 5.5.3.2 Ammonia – Haber-Bosch with gasification production route

With this production route, hydrogen is obtained by the gasification of hydrocarbons, typically from heavy feedstocks such as coal, heavy refinery fuels or other fossil feedstock. A synthesis gas containing hydrogen is produced, which has to be purified before it can be used for the next production step. Ammonia is then synthesised from the hydrogen produced and from nitrogen obtained from the air, at high temperature and pressure in the presence of a catalyst. Any carbon monoxide produced is almost all converted to carbon dioxide.

The Implementing Regulation (section 3 Annex II) defines the system boundaries for direct emissions monitoring for the Haber-Bosch process with gasification production route, as encompassing:

*“ – All fuels directly or indirectly linked to ammonia production, and materials used for flue gas cleaning.*

*– Each fuel input shall be monitored as one fuel stream, irrespective of whether it is used as energetic or non-energetic input.*

*– Where hydrogen from other production routes is added to the process, it shall be treated as a precursor with its own embedded emissions.”*

A relevant precursor is separately produced hydrogen, if used in the process. Indirect emissions that result from electricity consumed by the production process should also be monitored.

---

<sup>38</sup> For process steps see hydrogen sector section 5.4.3.1 above.

In line with the above definition of system boundaries, the following production steps may be regarded as being within the system boundaries of the Haber-Bosch with gasification process:

- Production of hydrogen by gasification (partial oxidation)<sup>39</sup>.
- Synthesis of ammonia – from hydrogen and nitrogen, at high temperature and pressure in the presence of a catalyst; ammonia condensation, purification and storage (if applicable).
- Emissions control – for treating releases to air, water or ground.

Note that the ammonia produced is reported as 100% ammonia, whether in hydrous or anhydrous form.

#### 5.5.3.3 Nitric acid (and sulphonitric acids) production process

Nitric acid is mostly produced via the oxidation of ammonia by Ostwald process. Ammonia is first oxidised in the presence of a catalyst to form nitrogen oxide, which is then further oxidised to nitrogen dioxide, followed by absorption in water in an absorption tower to form nitric acid. The reaction is exothermic and heat and power may be recovered to the process.

The Implementing Regulation (section 3 Annex II) defines the system boundaries for direct emissions monitoring for the nitric acid production route, as encompassing:

*“ – CO<sub>2</sub> from all fuels directly or indirectly linked to nitric acid production, and materials used for flue gas cleaning.*

*– N<sub>2</sub>O emissions from all sources emitting N<sub>2</sub>O from the production process, including unabated and abated emissions. Any N<sub>2</sub>O emissions from the combustion of fuels are excluded from monitoring.”*

A relevant precursor is ammonia (as 100% ammonia). Indirect emissions that result from electricity consumed by the production process should also be monitored.

In line with the above definition of systems boundaries, the following production steps may be regarded as being within the system boundaries of the nitric acid process production:

- Raw material preparation – evaporation and filtration of ammonia and process air.
- Oxidation of ammonia – to nitrogen oxide, all process steps.
- Further oxidation and absorption – to nitrogen dioxide and absorption in water to form nitric acid, all process steps.
- Emissions control – for treating releases to air, water or ground.

Note that nitric acid produced is reported as 100% nitric acid.

---

<sup>39</sup> For process steps see hydrogen sector section 5.4.3.2 above.



#### 5.5.3.4 Urea production process

Urea is synthesised by reacting ammonia and carbon dioxide together at high pressure, to form ammonium carbamate, which is then dehydrated to form urea.

The Implementing Regulation (section 3 Annex II) defines the system boundaries for direct emissions monitoring for the urea production route, as encompassing:

- “ – CO<sub>2</sub> from all fuels directly or indirectly linked to urea production, and materials used for flue gas cleaning.*
- Where CO<sub>2</sub> is received from another installation as process input, the CO<sub>2</sub> received and not bound in urea shall be considered an emission, if not already counted as emission of the installation where the CO<sub>2</sub> was produced, under an eligible monitoring, reporting and verification system.”*

A relevant precursor is ammonia (as 100% ammonia). Indirect emissions that result from electricity consumed by the production process should also be monitored.

In line with the above definition of systems boundaries, the following production steps may be regarded as being within the system boundaries of the urea production process:

- Raw material preparation – evaporation and filtration of ammonia, CO<sub>2</sub>.
- Production of urea – all process steps, from synthesis to particle formation.
- Emissions control – for treating releases to air, water or ground.

The ammonia and CO<sub>2</sub> consumed by this production process are usually delivered from other production processes on the same site.

#### 5.5.3.5 Mixed fertilizers production process

A wide range of operations are included in the production of all kinds of nitrogen containing mixed fertilizers (especially ammonium salts and NP, NK and NPK), such as mixing, neutralisation<sup>40</sup>, particle formation (such as by granulation or prilling), irrespective of whether only physical mixing or chemical reactions take place.

The Implementing Regulation (section 3 Annex II) defines the system boundaries for direct emissions monitoring for the mixed fertilizer production route, as encompassing:

- “ – CO<sub>2</sub> from all fuels directly or indirectly linked to fertilizer production, such as fuels used in driers and for heating input materials, and materials used for flue gas cleaning.”*

Relevant precursors (if used in the process) are: ammonia (as 100% ammonia); nitric Acid (as 100% nitric acid); urea; mixed fertilizers (in particular salts containing ammonium or nitrate). Indirect emissions that result from electricity consumed by the production process should also be monitored.

---

<sup>40</sup> Nitrogen containing chemical fertilizers are produced by the neutralisation of an acid with ammonia to form the corresponding ammonium salt. Fertilizers produced in this way include ammonium nitrate, calcium ammonium nitrate, ammonium sulphate, ammonium phosphates, urea ammonium nitrate.

In line with the above definition of systems boundaries, the following production steps may be regarded as being within the system boundaries of the mixed fertilizer production process:

- Raw material preparation.
- Production of mixed fertilizer – all process steps.
- Emissions control – for treating releases to air, water or ground.

A **case study** showing how direct and indirect specific embedded emissions (SEE) values are derived for **mixed fertilizer production process**, and how the embedded emissions of imports into the EU are calculated, is given in section 7.3.2.

## 5.6 Iron and Steel sector

The textbox below signposts sector-specific sections in the Implementing Regulation, relevant for the CBAM transitional period.

---

### Implementing Regulation references:

- **Annex II**, Section 2, Table 1 Mapping of CN codes to aggregated goods categories.
  - **Annex II**, Section 3 Production routes, system boundaries, and relevant precursors, as specified in sub-sections: 3.11 – Sintered ore; 3.12 – Ferro-manganese, Ferro-chromium, Ferro-nickel; 3.13 – Pig iron; 3.14 – DRI; 3.15 – Crude steel; and 3.16 – Iron or steel products.
- 

### 5.6.1 Unit of production and embedded emissions

The quantity of declared iron and steel sector goods imported into the EU should be expressed in metric tonnes. As an operator, you should record the quantity of CBAM goods produced by your installation in each production process, for the purposes of reporting.

<b>Industrial sector</b>	<b>Iron and steel</b>
<b>Production unit of goods</b>	Tonnes (metric), reported separately for each type of sector goods, by installation or production process in the country of origin
<b>Associated activities</b>	Producing, melting or refining iron or steel or ferrous alloys; manufacture of semi-finished and basic steel products.
<b>Relevant greenhouse gas</b>	Carbon dioxide (CO <sub>2</sub> )
<b>Direct Emissions</b>	Tonnes (metric) of CO <sub>2</sub> e
<b>Indirect Emissions</b>	Quantity of electricity consumed (MWh), source and emissions factor used to calculate the indirect emissions in Tonnes (metric) of CO <sub>2</sub> or CO <sub>2</sub> e.  <i>To be reported separately during transitional period.</i>

---

<b>Unit for embedded emissions</b>	Tonnes CO <sub>2</sub> e emissions per tonne of goods, reported separately for each type of goods, by installation in the country of origin
------------------------------------	---

The iron and steel sector has to account for both direct emissions and indirect emissions in the transitional period. Indirect emissions are to be reported separately<sup>41</sup>. Emissions should be reported in metric tonnes CO<sub>2</sub> equivalent (t CO<sub>2</sub>e) emissions per tonne of output. This figure should be calculated for the specific installation or production process in your country of origin.

Note that several **case studies** showing how direct and indirect specific embedded emissions (SEE) values are derived for **iron to steel products**, using the mass balance method, and how the embedded emissions of imports into the EU are calculated, are given in section 7.2.2.

The following sections set out how the system boundaries of iron and steel sector goods should be defined, and identify elements of the production process that should be included for the purposes of monitoring and reporting.

### 5.6.2 Definition and explanation of sector CBAM goods covered

The following Table 5-6 lists the relevant goods in scope for the CBAM transitional period in the iron and steel industry sector. The aggregated goods category in the left hand column defines groups for which joint ‘production processes’ are to be defined for the purpose of monitoring.

Table 5-6: CBAM goods in the iron and steel sector

<b>Aggregated goods category</b>	<b>Product CN Code</b>	<b>Description</b>
<b>Sintered Ore<sup>42</sup></b>	2601 12 00	Agglomerated iron ores and concentrates, other than roasted iron pyrites
<b>Pig iron</b>	7201	Pig iron and spiegeleisen <sup>43</sup> in pigs, blocks or other primary forms
	7205 <sup>44</sup>	Some products under 7205 (Granules and powders, of pig iron, spiegeleisen, iron, or steel) may be covered here

<sup>41</sup> Note that for this sector indirect emissions are only reported during the transitional period (and not during the definitive period).

<sup>42</sup> This aggregated goods category includes all kinds of iron ore pellet production (for sale of pellets as well as for direct use in the same installation) and sinter production.

<sup>43</sup> Pig iron containing alloy ferro-manganese.

<sup>44</sup> Only some products of this CN code will qualify as “pig iron”, while other goods of this code are classified as “iron or steel products”

<b>Aggregated goods category</b>	<b>Product CN Code</b>	<b>Description</b>
<b>Ferro-alloy: FeMn</b>	7202 1	Ferro-manganese (FeMn)
<b>Ferro-alloy: FeCr</b>	7202 4	Ferro-chromium (FeCr)
<b>Ferro-alloy: FeNi</b>	7202 6	Ferro-nickel (FeNi)
<b>DRI</b>	7203	Ferrous products obtained by direct reduction of iron ore and other spongy ferrous products
<b>Crude steel</b>	7206, 7207, 7218 and 7224	7206 – Iron and non-alloy steel in ingots or other primary forms (excluding iron of heading 7203) 7207 – Semi-finished products of iron or non-alloy steel 7218 – Stainless steel in ingots or other primary forms; semi-finished products of stainless steel 7224 – Other alloy steel in ingots or other primary forms; semi-finished products of other alloy steel
<b>Iron or steel products<sup>45</sup></b>	Includes: 7205, 7208-7217, 7219-7223, 7225-7229, 7301-7311, 7318 and 7326	7205 – Granules and powders, of pig iron, spiegeleisen, iron or steel (if not covered under category pig iron) 7208 – Flat-rolled products of iron or non-alloy steel, of a width of 600 mm or more, hot-rolled, not clad, plated or coated 7209 – Flat-rolled products of iron or non-alloy steel, of a width of 600 mm or more, cold-rolled (cold-reduced), not clad, plated or coated 7210 – Flat-rolled products of iron or non-alloy steel, of a width of 600 mm or more, clad, plated or coated 7211 – Flat-rolled products of iron or non-alloy steel, of a width of less than 600 mm, not clad, plated or coated 7212 – Flat-rolled products of iron or non-alloy steel, of a width of less than 600 mm, clad, plated or coated 7213 – Bars and rods, hot-rolled, in irregularly wound coils, of iron or non-alloy steel

<sup>45</sup> This aggregated goods category includes semi-finished and finished products.

Aggregated goods category	Product CN Code	Description
		7214 – Other bars and rods of iron or non-alloy steel, not further worked than forged, hot-rolled, hot-drawn or hot-extruded, but including those twisted after rolling
		7215 – Other bars and rods of iron or non-alloy steel
		7216 – Angles, shapes and sections of iron or non-alloy steel
		7217 – Wire of iron or non-alloy steel
		7219 – Flat-rolled products of stainless steel, of a width of 600 mm or more
		7220 – Flat-rolled products of stainless steel, of a width of less than 600 mm
		7221 – Bars and rods, hot-rolled, in irregularly wound coils, of stainless steel
		7222 – Other bars and rods of stainless steel; angles, shapes and sections of stainless steel
		7223 – Wire of stainless steel
		7225 – Flat-rolled products of other alloy steel, of a width of 600 mm or more
		7226 – Flat-rolled products of other alloy steel, of a width of less than 600 mm
		7227 – Bars and rods, hot-rolled, in irregularly wound coils, of other alloy steel
		7228 – Other bars and rods of other alloy steel; angles, shapes and sections, of other alloy steel; hollow drill bars and rods, of alloy or non-alloy steel
		7229 – Wire of other alloy steel
		7301 – Sheet piling of iron or steel, whether or not drilled, punched or made from assembled elements; welded angles, shapes and sections, of iron or steel
		7302 – Railway or tramway track construction material of iron or steel, the following: rails, check-rails and rack rails, switch blades, crossing frogs, point rods and other crossing pieces, sleepers (cross-ties), fish-plates, chairs, chair wedges, sole plates (base plates), rail clips, bedplates, ties and other material specialised for jointing or fixing rails
		7303 – Tubes, pipes and hollow profiles, of cast iron
		7304 – Tubes, pipes and hollow profiles, seamless, of iron (other than cast iron) or steel

Aggregated goods category	Product CN Code	Description
		7305 – Other tubes and pipes (for example, welded, riveted or similarly closed), having circular cross-sections, the external diameter of which exceeds 406,4 mm, of iron or steel
		7306 – Other tubes, pipes and hollow profiles (for example, open seam or welded, riveted or similarly closed), of iron or steel
		7307 – Tube or pipe fittings (for example, couplings, elbows, sleeves), of iron or steel
		7308 – Structures (excluding prefabricated buildings of heading 9406) and parts of structures (for example, bridges and bridge-sections, lock-gates, towers, lattice masts, roofs, roofing frameworks, doors and windows and their frames and thresholds for doors, shutters, balustrades, pillars and columns), of iron or steel; plates, rods, angles, shapes, sections, tubes and the like, prepared for use in structures, of iron or steel
		7309 – Reservoirs, tanks, vats and similar containers for any material (other than compressed or liquefied gas), of iron or steel, of a capacity exceeding 300 l, whether or not lined or heat-insulated, but not fitted with mechanical or thermal equipment
		7310 – Tanks, casks, drums, cans, boxes and similar containers, for any material (other than compressed or liquefied gas), of iron or steel, of a capacity not exceeding 300 l, whether or not lined or heat-insulated, but not fitted with mechanical or thermal equipment
		7311 – Containers for compressed or liquefied gas, of iron or steel
		7318 – Screws, bolts, nuts, coach screws, screw hooks, rivets, cotters, cotter pins, washers (including spring washers) and similar articles, of iron or steel
		7326 – Other articles of iron or steel

Source: The CBAM Regulation, Annex I; Implementing Regulation, Annex II.

The aggregated goods categories listed in Table 5-6 include both finished goods and precursor goods (intermediate products) that are consumed in the production of iron or steel products. Only input materials listed as relevant precursors to the system boundaries of the production process as specified in the Implementing Regulation are to be considered. Table 5-7 below lists the possible precursors by aggregated goods category and production route.

Table 5-7: Aggregated goods categories, their production routes and possibly relevant precursors

Aggregated Goods Category	Relevant precursors
<i>Production route</i>	
Sintered Ore	None
Ferro alloys (FeMn, FeCr, FeNi)	Sintered ore, if used in the process.
Pig iron <i>Blast furnace route</i> <i>Smelting reduction</i>	Hydrogen, sintered ore, ferro alloys, pig iron/DRI (the latter if obtained from other installations or production processes and used in the process).
Direct Reduced Iron (DRI)	Hydrogen, sintered ore, ferro alloys, pig iron/DRI (the latter if obtained from other installations or production processes and used in the process).
Crude steel <i>Basic oxygen steelmaking</i> <i>Electric arc furnace</i>	Ferro alloys, pig iron, DRI, crude steel (the latter if obtained from other installations or production processes and used in the process).
Iron or steel products	Ferro alloys, pig iron, DRI, crude steel, iron or steel products (if used in the process).

Not all precursors will apply in every case. For example, hydrogen may only become relevant in the future.

Note in particular that in some cases an aggregated goods category may be precursor for its own category. This is best explained by an example:

**Example:** If an installation produces screws and nuts from steel rods, then the rods are the precursor, but both rods and screws and nuts are included in the same aggregated goods category.

The embedded emissions of the screws and nuts will be composed of the emissions of the production process (heat applied for making the rods workable, and for annealing of the final product) plus the embedded emissions of the steel rods. Note that this is important because the mass of the precursor rods and the mass of the final product screws and nuts will not be the same – if e.g. 20% of the original mass are cut away (and disposed of as scrap), 100 t precursor are required for 80 t of final product.

Some types of iron or steel product have been excluded from the scope of the CBAM. In particular, these include certain other types of ferro alloys under CN 7202 and CN 7204 – ferro scrap.

The production of iron and steel sector goods is by a number of different process routes, outlined below.

### 5.6.3 Definition and explanation of relevant production processes and emissions covered

The system boundaries of precursors and basic iron and steel finished goods are distinct and may, under certain conditions, be added together to include all processes directly or indirectly linked to the production processes for these goods, including input activities to the process, and output activities from the process (see section 6.3).

The following diagram illustrates the different routes by which iron or steel products may be produced.

Figure 5-5: System boundaries and value chain for the production of iron or steel products.

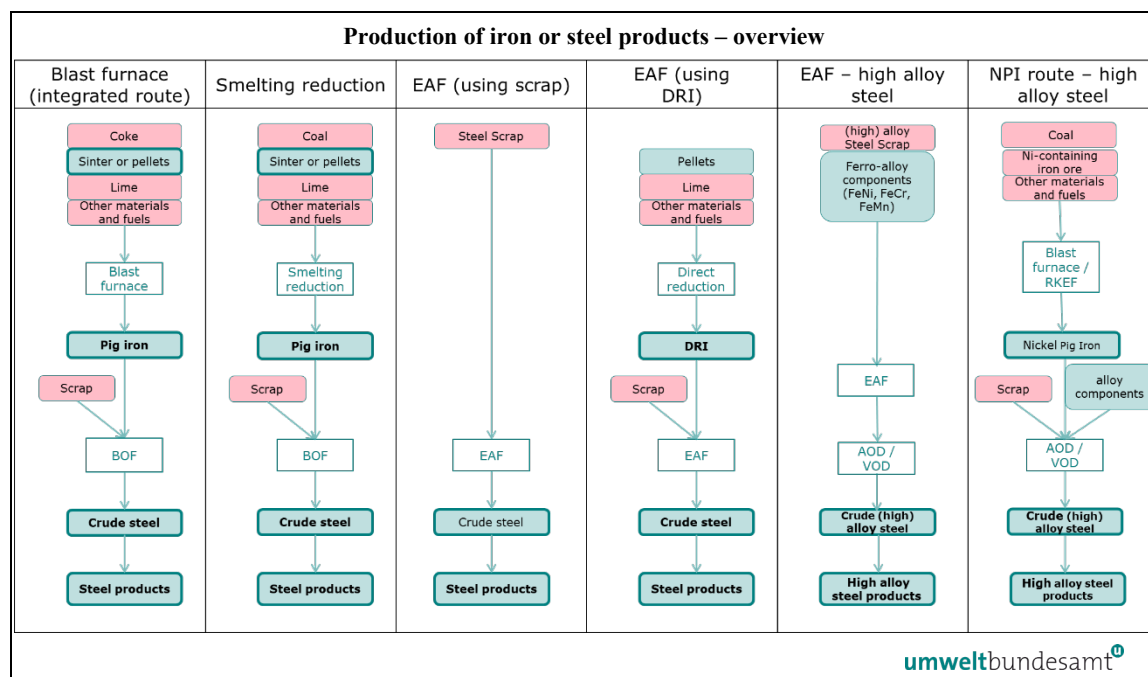

The production of precursor and finished goods is by a number of different process routes, outlined in the following sections. The relevant emissions that should be monitored for the iron and steel sector are detailed in section 7.2.1.1.

#### 5.6.3.1 Sintered ore production process

This aggregated goods category includes all kinds of iron ore pellet production (for sale of pellets as well as for direct use in the same installation) and sinter production. Pelletisation and sintering are complementary process routes for preparing and agglomerating iron oxide raw materials for use in iron and steel making. In pelletisation, iron oxide raw materials are ground and combined with additives to form pellets, which are then thermally treated. In sintered ore production, iron oxide raw materials are mixed with coke breeze and other additives before the mixture is sintered together in a kiln, forming a porous material similar to clinker, called ‘sinter’. Sinter is typically produced and used at the steelworks. Pellets may be produced at the steelworks or at a distance at mine sites.

Note that ferro-alloy pellets and sinter produced from iron ores may also be covered by this production process (for CN code 2601 12 00).



The Implementing Regulation (section 3 Annex II) defines the system boundaries for direct emissions monitoring for the sintered ore production route, as encompassing:

“ – CO<sub>2</sub> from process materials such as limestone and other carbonates or carbonatic ores.

– CO<sub>2</sub> from all fuels including coke, waste gases such as coke oven gas, blast furnace gas or converter gas; directly or indirectly linked to the production process, and materials used for flue gas cleaning.”

There are no relevant precursors for this production process. Indirect emissions that result from electricity consumed by the production process should also be monitored.

In line with the above definition of systems boundaries, the following production steps may be regarded as being within the system boundaries of iron ore pellet and sinter production:

- Raw material handling and pre-treatment – drying and grinding of iron ore raw materials.
- Blending and mixing of raw materials – preparation of raw mixture for pellets and for sinter. Storage of raw mix in bunkers or hoppers at the start of the process.
- Iron ore pellets only – forming into pellets and thermal treatment, screening.
- Sintered ore only – raw material preparation, sintering in a furnace, followed by crushing, screening, conveying and cooling.
- Emissions control – in particular waste gas treatment.

The following *Figure 5-6* shows the system boundaries of the sinter (or iron ore pellets) production process.

*Figure 5-6: System boundaries of the sintered ore production process*

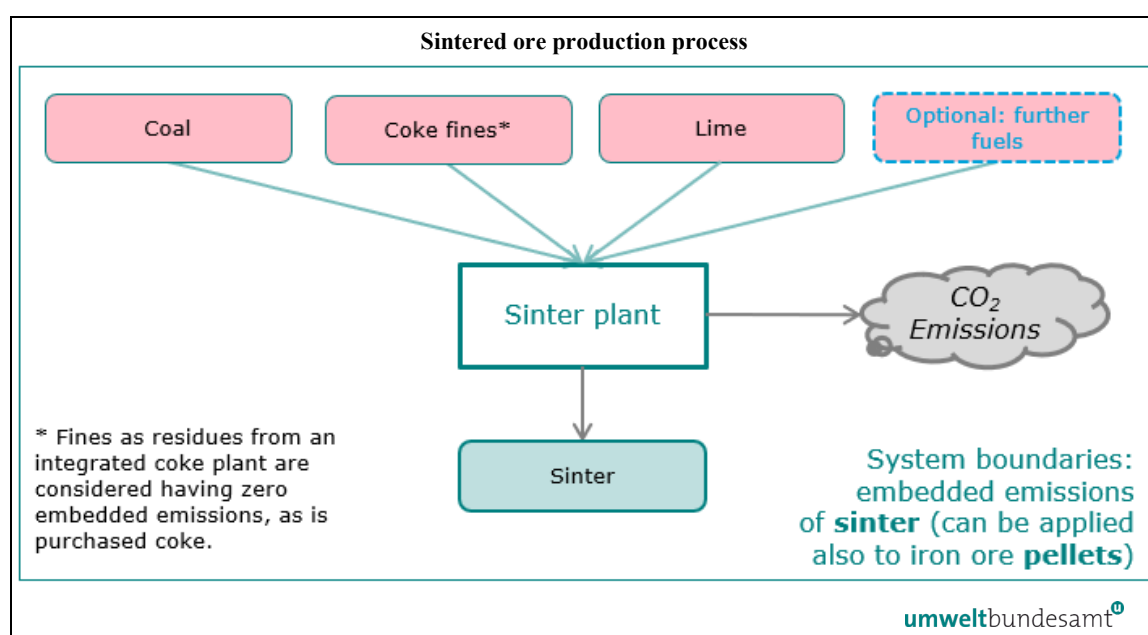

### 5.6.3.2 Ferro-alloy FeMn, FeCr, and FeNi production processes

This process covers the production of the alloys ferro-manganese (FeMn), ferro-chromium (FeCr), ferro-nickel (FeNi), identified under CN codes 7202 1, 7202 4 and 7202 6. Other iron materials with significant alloy content such as spiegeleisen are not covered here (see section 5.6.3.3). However, nickel pig iron (NPI) is included if the nickel content is greater than 10%; otherwise, if less than 10% NPI is covered by the pig iron – blast furnace production route.

The different ferro-alloys are produced by reductive smelting with the addition of a reducing agent such as coke to the EAF, along with other additives. Different types of EAF may be used, depending on the ferro-alloy production process; Ferro-nickel has an additional calcination and pre-reduction production step prior to smelting. Following EAF smelting, liquid metal alloy is tapped and cast in moulds and the solidified metal is then crushed or granulated, depending on customer requirements.

The Implementing Regulation (section 3 Annex II) defines the system boundaries for direct emissions monitoring for ferro-alloys FeMn, FeCr and FeNi pig iron production processes, as encompassing:

- “ – CO<sub>2</sub> emissions caused by fuel inputs, irrespective of whether they are used for energetic or non-energetic use.*
- CO<sub>2</sub> emissions from process inputs such as limestone and from flue gas cleaning.*
- CO<sub>2</sub> emissions from the consumption of electrodes or electrode pastes.*
- Carbon remaining in the product or in slags or wastes is taken into account by using a mass balance method in accordance with Section B.3.2 of Annex III.”*

A relevant precursor is sintered ore (if used in the process). Indirect emissions that result from electricity consumed by the production process should also be monitored.

In line with the above definition of systems boundaries, the following production steps may be regarded as being within the system boundaries of ferro-alloy installations:

- Raw material handling and pre-treatment – pellets and sinter for FeMn and FeCr, calcination and pre-reduction in a rotary kiln for FeNi.
- EAF process – all steps for the EAF process, including charging, melting, primary refining and tapping of the primary furnace.
- Decarburisation and secondary metallurgy – if required to produce ferro-alloys with different carbon contents.
- Casting plant – including casting and cutting, casting ingots pre-heating stands.
- Crushing and granulation.
- Emissions control – for treating releases to air, water or ground, including dedusting units, post-combustion unit, slag handling.

The following *Figure 5-7* shows the system boundaries of the relevant ferro-alloy production processes.

Figure 5-7: System boundaries of Ferro-alloy production processes.

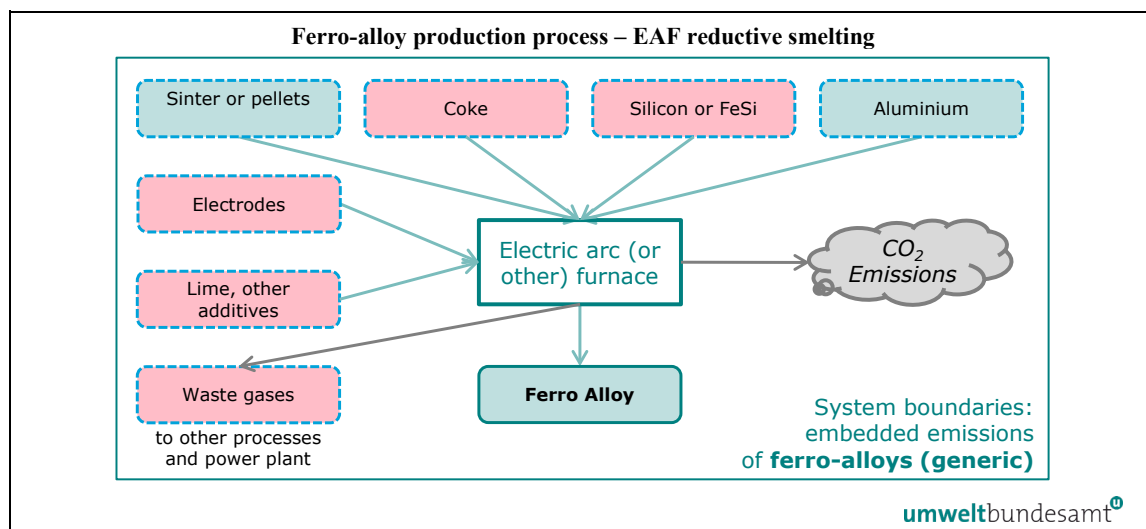

Note that raw material inputs for ferro-alloys may include pellets and sinter that are produced under the separate production process (for CN code 2601 12 00) for sintered iron ore.

The mass balance method is used to give a complete balance of the amount of carbon entering or leaving (carbon remaining in steel, in wastes or in slag) the EAF production process. A **case study** showing how the mass balance method is applied is given in section 7.2.2.2.

### 5.6.3.3 Pig iron – Blast furnace production route

The blast furnace production route produces liquid pig iron (“hot metal”) that may be alloyed (e.g. spiegeleisen and nickel pig iron or NPI<sup>46</sup>) or non-alloyed. The main production unit for this production process is the blast furnace. Inputs into the blast furnace include iron ore pellets or sintered ore, fuels and other raw materials including those used as reducing agents. Inside the blast furnace iron oxide is reduced to iron metal. The hot metal produced is then tapped and is either cast, or is directly converted to crude steel in a sequential step by the basic oxygen converter. This step is covered under a different production process, the crude steel – basic oxygen steelmaking production route.

The Implementing Regulation (section 3 Annex II) defines the system boundaries for direct emissions monitoring for the pig iron – Blast furnace production route, as encompassing:

“ – CO<sub>2</sub> from fuels and reducing agents such as coke, coke dust, coal, fuel oils, plastic wastes, natural gas, wood wastes, charcoal, as well as from waste gases such as coke oven gas, blast furnace gas or converter gas.

– Where biomass is used, the provisions of Section B.3.3 of Annex III shall be taken into account.

<sup>46</sup> NPI is covered by this production process if the nickel content is lower than 10%, otherwise if more than 10% it is covered under the ferro-alloy production process.

–  $CO_2$  from process materials such as limestone, magnesite, and other carbonates, carbonatic ores; materials for flue gas cleaning.

– Carbon remaining in the product or in slags or wastes is taken into account by using a mass balance method in accordance with Section B.3.2 of Annex III.”

Relevant precursors (if used in the process) are: sintered ore; pig iron or DRI from other installations or production processes; ferro-alloys FeMn, FeCr, FeNi; and hydrogen, if used. Indirect emissions that result from electricity consumed by the production process should also be monitored.

In line with the above definition of systems boundaries, the following production steps may be regarded as being within the system boundaries of blast furnace installations:

- Raw material handling and pre-treatment.
- Fuel storage and preparation – e.g. coal drying and preparation for pulverized coal injection (PCI), vessels preheating stands.
- Hot metal production – all steps for the blast furnace process resulting in liquid pig iron, the main unit being the Blast furnace, along with hot metal treatment units, blast furnace blowers, blast furnace hot stoves, compressed air production, steam injection in the blast furnace unit, steam generation plant, etc.
- Emissions control – for treating releases to air, water or ground, including slag treatment, waste gas treatment, dedusting units, dust briquetting.
- Miscellaneous not covered above.

The following *Figure 5-8* shows the system boundary for the blast furnace production route.

If all the liquid pig iron from the blast furnace was used by the oxygen steelmaking process to produce crude steel, then there would be no need to monitor emissions from the blast furnace production route separately. Instead, a joint production process for crude steel making may be defined.

The mass balance method is used to give a complete balance of the amount of carbon entering or leaving (carbon remaining in the product, or in wastes or slags) the production process. A **case study** showing how the mass balance method is applied is given in section 7.2.2.1.

Figure 5-8: System boundaries of the Pig iron – Blast furnace production route.

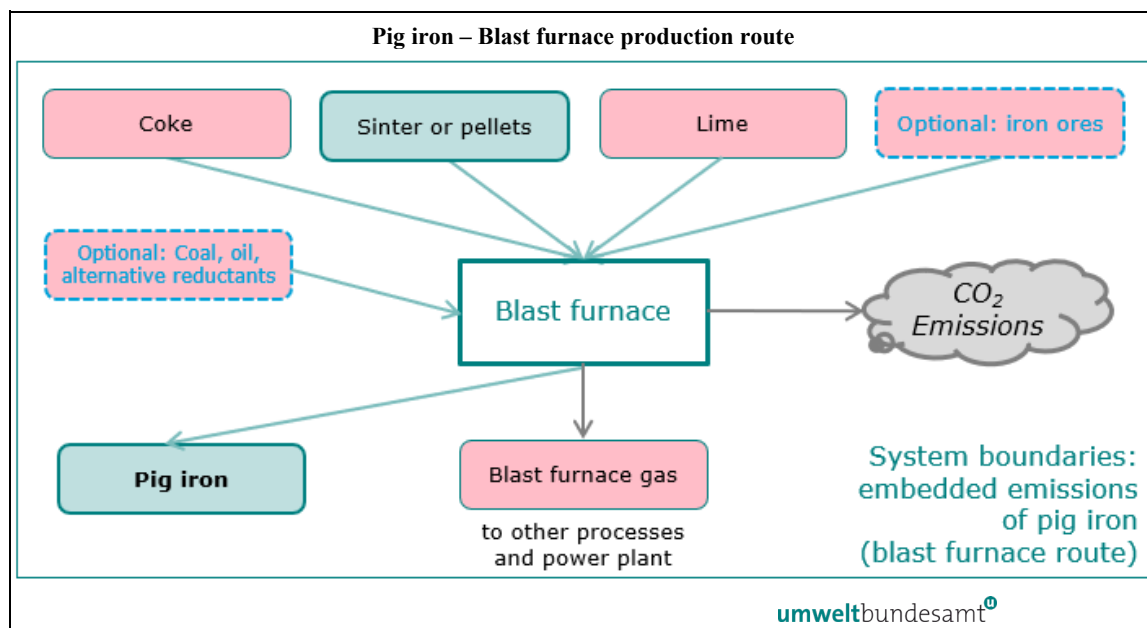

#### 5.6.3.4 Pig iron – Smelting reduction production route

Smelting reduction produces pig iron from precursor sintered ore, iron ore pellets, or ironmaking residues, using different fuels and reducing agents. The process comprises two steps, the reduction of iron ore followed by melting to produce liquid pig iron / hot metal.

The Implementing Regulation (section 3 Annex II) defines the system boundaries for direct emissions monitoring for the pig iron – smelting reduction production route, as encompassing:

“ – CO<sub>2</sub> from fuels and reducing agents such as coke, coke dust, coal, fuel oils, plastic wastes, natural gas, wood wastes, charcoal, waste gases from the process or converter gas, etc.

– Where biomass is used, the provisions of Section B.3.3 of Annex III shall be taken into account.

– CO<sub>2</sub> from process materials such as limestone, magnesite, and other carbonates, carbonatic ores; materials for flue gas cleaning.

– Carbon remaining in the product or in slags or wastes is taken into account by using a mass balance method in accordance with Section B.3.2 of Annex III.”

Relevant precursors (if used in the process) are: sintered ore; pig iron or DRI from other installations or production processes; ferro-alloys FeMn, FeCr, FeNi; and hydrogen, if used. Indirect emissions that result from electricity consumed by the production process should also be monitored.

In line with the above definition of systems boundaries, the following production steps may be regarded as being within the system boundaries of smelting reduction installations:

- Raw material handling and pre-treatment.
- Fuel storage and preparation.
- Smelting reduction process – all steps for the smelting process, resulting in hot metal.
- Casting plant.
- Emissions control – in particular flue gas cleaning.

The following *Figure 5-9* shows the system boundaries of the smelting reduction process for producing pig iron.

*Figure 5-9: System boundaries of the Pig iron – smelting reduction production route.*

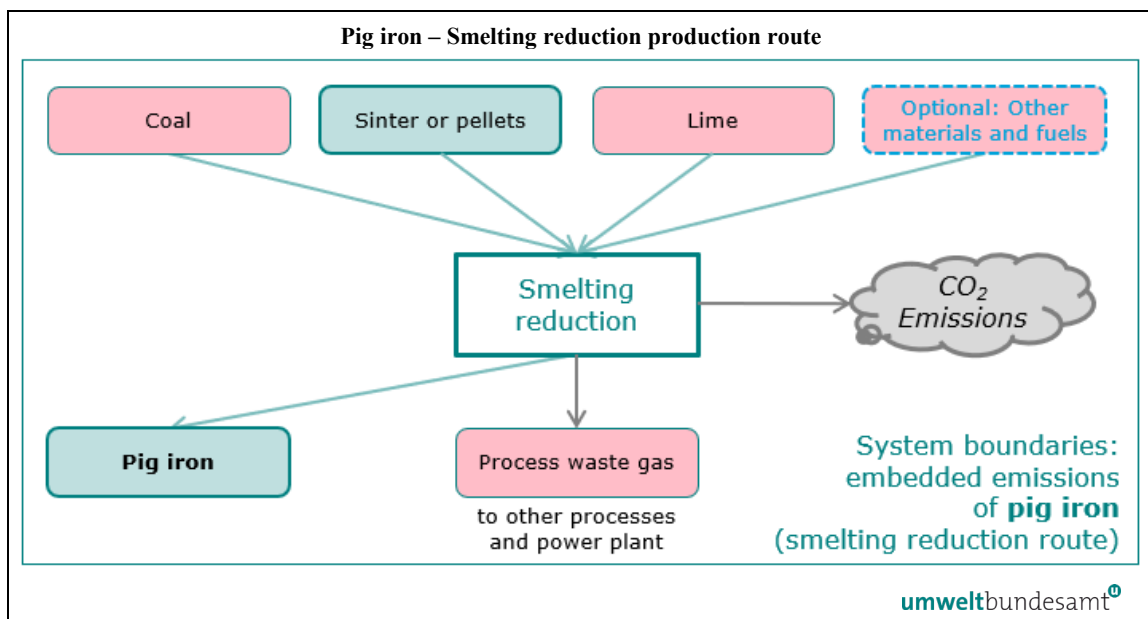

The mass balance method is used to give a complete balance of the amount of carbon entering or leaving (as carbon remaining in the product, or in wastes or slags) the production process. A **case study** showing how the mass balance method is applied is given in section 7.2.2.1.

#### 5.6.3.5 Direct Reduced Iron (DRI) production process

Direct reduction involves the production of solid primary iron from high grade iron ores (pellets, sinter or concentrates). There are different technologies that may use different qualities of ores (which may require pelletisation or sintering) and different fuels and reducing agents (natural gas, diverse fossil fuels or biomass, hydrogen). The solid product is called direct reduced iron (DRI). Different types of DRI are produced, for example ‘iron sponge’ and hot briquetted iron (HBI). Some DRI is used directly as a feedstock in EAFs or for other downstream processes. It is expected that production routes using hydrogen will play a major role in decarbonising the steel industry in coming years.

The Implementing Regulation (section 3 Annex II) defines the system boundaries for direct emissions monitoring for the DRI production route, as encompassing:

*“ – CO<sub>2</sub> from fuels and reducing agents such as natural gas, fuel oils, waste gases from the process or converter gas, etc.*

*– Where biogas or other forms of biomass are used, the provisions of Section B.3.3 of Annex III shall be taken into account.*

*– CO<sub>2</sub> from process materials such as limestone, magnesite, and other carbonates, carbonatic ores; materials for flue gas cleaning.*

*– Carbon remaining in the product or in slags or wastes is taken into account by using a mass balance method in accordance with Section B.3.2 of Annex III.”*

Relevant precursors (if used in the process) are: sintered ore; hydrogen; pig iron or DRI from other installations or production processes; and ferro-alloys FeMn, FeCr, FeNi, if used. Indirect emissions that result from electricity consumed by the production process should also be monitored.

In line with the above definition of systems boundaries, the following production steps may be regarded as being within the system boundaries of DRI installations:

- Raw material handling and pre-treatment.
- Fuel storage and preparation – coal, natural gas or hydrogen etc.
- Direct reduction process for iron production – all steps for the DRI process, forming into hot briquetted iron (HBI) if applicable.
- Emissions control – in particular flue gas cleaning.

The following *Figure 5-10* shows the system boundaries of the relevant processes for DRI production. Although there are several different processes used in practice, the high-level system boundaries are very similar and can therefore be represented on a single diagram.

Note that where an installation does not sell or transfer DRI produced to other installations, there is no need to monitor emissions from the DRI production process separately. A common production process including steelmaking may be used.

The mass balance method is used to give a complete balance of the amount of carbon entering or leaving (as carbon remaining in the product, or in wastes or slags) the production process. A **case study** showing how the mass balance method is applied is given in section 7.2.2.1.

Figure 5-10: System boundaries of the DRI production process

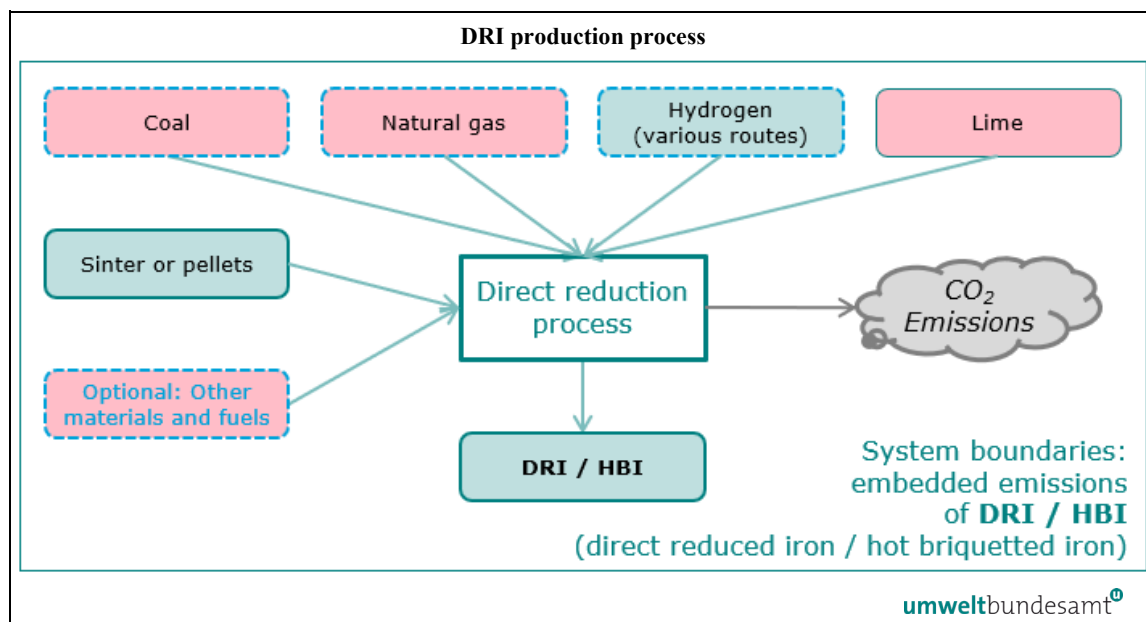

#### 5.6.3.6 Crude steel – Basic oxygen steelmaking production route

If the basic oxygen steelmaking production route starts with hot metal (liquid pig iron); the hot metal is directly converted to crude steel by the basic oxygen converter or furnace (BOF) as part of a continuous process. Following the converter, a steel decarburisation process by argon oxygen decarburisation (AOD) or vacuum oxygen decarburisation (VOD) may be performed, followed by various secondary metallurgical processes such as vacuum degassing to remove dissolved gases. Crude steel is then cast into its primary forms by continuous casting or ingot casting, which may be followed by hot-rolling or forging to obtain the semi-finished crude steel products (under CN codes 7207, 7218 and 7224).

The Implementing Regulation (section 3 Annex II) defines the system boundaries for direct emissions monitoring for the Crude steel – basic oxygen production route, as encompassing:

“ – CO<sub>2</sub> from fuels such as coal, natural gas, fuel oils, waste gases such as blast furnace gas, coke oven gas or converter gas, etc.

– CO<sub>2</sub> from process materials such as limestone, magnesite, and other carbonates, carbonatic ores; materials for flue gas cleaning.”

– Carbon entering the process in scrap, alloys, graphite etc. and carbon remaining in the product or in slags or wastes is taken into account by using a mass balance method in accordance with Section B.3.2 of Annex III.”

Relevant precursors (if used in the process) are: pig iron, DRI; ferro-alloys FeMn, FeCr, FeNi; and crude steel from other installations or production processes, if used. Indirect emissions that result from electricity consumed by the production process should also be monitored.



In line with the above definition of systems boundaries, the following production steps may be regarded as being within the system boundaries of basic oxygen steelmaking installations:

- Basic oxygen converter or furnace (BOF).
- Decarburisation – AOD or VOD processes, where relevant.
- Secondary metallurgy and vacuum degassing.
- Casting plant – continuous casting or ingot casting, preheating equipment.
- Hot rolling or forging – where relevant, only primary hot-rolling and rough shaping by forging to obtain the semi-finished products.
- All necessary auxiliary activities – such as transfers, re-heating.
- Emissions control – in particular flue gas cleaning, dedusting units, slag handling.

Note that only primary hot-rolling and rough shaping by forging to obtain the semi-finished products under CN codes 7207, 7218 and 7224 are included in this aggregated goods category. All other rolling and forging processes are included in the aggregated goods category “iron or steel products”.

Figure 5-11: System boundaries of basic oxygen steelmaking and related processes.

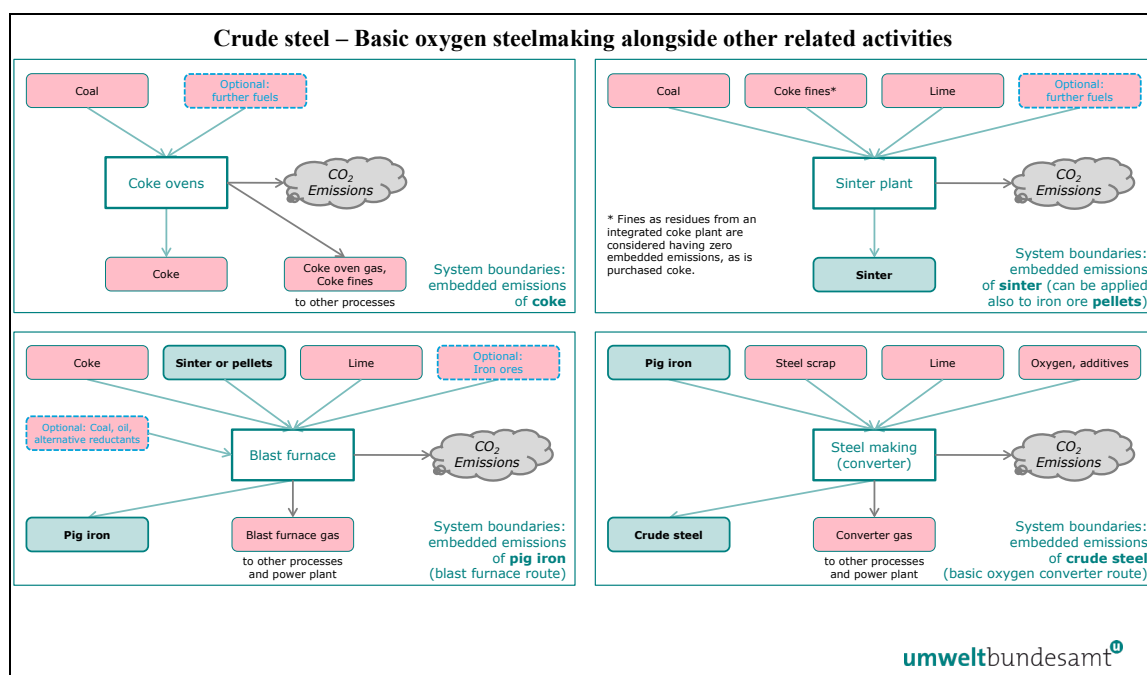

In integrated steel plants, liquid pig iron that is directly charged to the oxygen converter is the product which separates the production process for pig iron (bottom left in Figure 5-11 above) from the production process of crude steel (bottom right, above).

The integrated blast furnace / basic oxygen furnace (BF/BOF) steelmaking process is by far the most complex steel making process and is characterised by networks of interdependent material and energy flows between the various production units. Note that coke (top left) is treated as a raw material with no embedded emissions.

When all the liquid pig iron from the blast furnace is used by the oxygen steelmaking process to produce crude steel, there is no need to monitor emissions from the blast furnace production route separately. Instead, a joint production process for crude steel making may be defined.

The mass balance method is used to give a complete balance of the amount of carbon entering or leaving (carbon remaining in steel product, or in wastes and slags) the production process.

A **case study** of how the mass balance method is applied for this production route is given in section 7.2.2.1.

#### 5.6.3.7 Crude steel – EAF steelmaking production route

The direct smelting of materials which contain iron is usually performed in an electric arc furnace (EAF). Feedstocks for EAF routes are metallic iron; in particular ferrous scrap<sup>47</sup> and/or Direct Reduced Iron (DRI). Where significant amounts of DRI are used, one of the various EAF-DRI routes applies. Following EAF smelting, a steel decarburisation process by argon oxygen decarburisation (AOD) or vacuum oxygen decarburisation (VOD) may be performed, followed by various secondary metallurgical processes such as desulphurisation and vacuum degassing to remove dissolved gases. Electricity is the main energy input to the EAF.

The Implementing Regulation (section 3 Annex II) defines the system boundaries for direct emissions monitoring for the Crude steel – EAF production route, as encompassing:

*“ – CO<sub>2</sub> from fuels such as coal, natural gas, fuel oils, as well as from waste gases such as blast furnace gas, coke oven gas or converter gas.*

*– CO<sub>2</sub> from the consumption of electrodes and electrode pastes.*

*– CO<sub>2</sub> from process materials such as limestone, magnesite, and other carbonates, carbonatic ores; materials for flue gas cleaning.*

*– Carbon entering the process, e.g. in the form of scrap, alloys and graphite, and carbon remaining in the product or in slags or wastes is taken into account by using a mass balance method in accordance with Section B.3.2 of Annex III.”*

Relevant precursors (if used in the process) are: pig iron, DRI; ferro-alloys FeMn, FeCr, FeNi; and crude steel from other installations or production processes, if used. Indirect emissions that result from electricity consumed by the production process are also to be monitored.

In line with the above definition of systems boundaries, the following production steps may be regarded as being within the system boundaries of EAF steelmaking installations – all relevant activities and production units, such as:

- Raw material handling and pre-treatment– scrap drying and pre-heating of raw materials.

---

<sup>47</sup> Where only post-consumer scrap is used, it is assumed to have zero embedded emissions

- EAF process – all steps for the EAF process, including charging, melting, primary refining and steel and slag tapping of the primary furnace.
- Decarburisation – AOD or VOD processes, where relevant.
- Secondary metallurgy and vacuum degassing.
- Casting plant – continuous casting or ingot casting, preheating equipment.
- Hot rolling or forging – where relevant, only primary hot-rolling and rough shaping by forging to obtain the semi-finished products.
- All necessary auxiliary activities – such as transfers, heating of equipment, re-heating.
- Emissions control – in particular flue gas cleaning, dedusting units, slag handling.

Note that only primary hot-rolling and rough shaping by forging to obtain the semi-finished products under CN codes 7207, 7218 and 7224 are included in this aggregated goods category. All other rolling and forging processes are included in the aggregated goods category “iron or steel products”.

Figure 5-12: System boundaries of the Crude steel – EAF steelmaking production route.

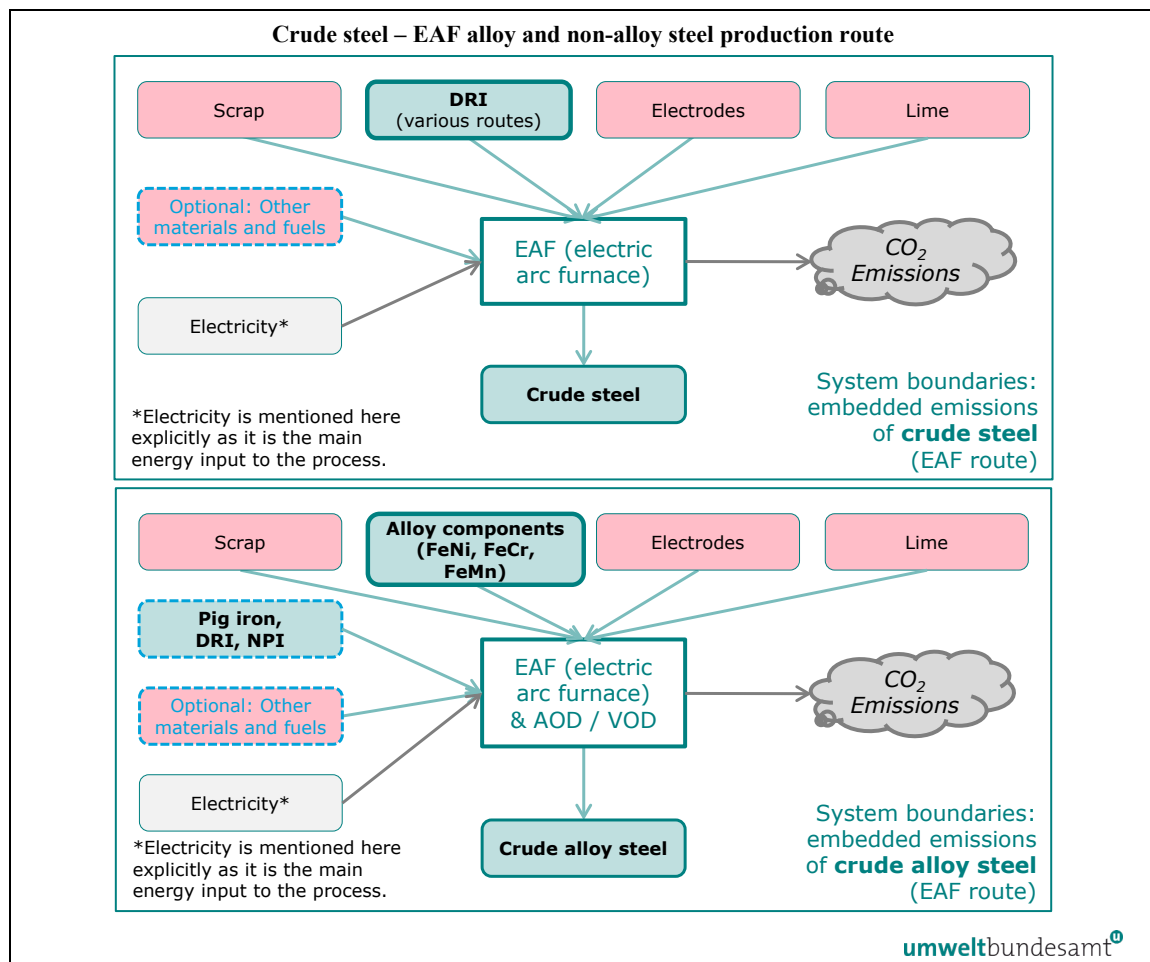

There are several different EAF production routes, for crude steel and crude alloy steel, which are broadly similar and are shown jointly in Figure 5-12.

The mass balance method is used to give a complete balance of the amount of carbon entering or leaving (carbon remaining in steel, in wastes and in slag) the EAF production process.

A **case study** showing how the mass balance method is applied for this production route is given in section 7.2.2.2.

#### 5.6.3.8 *Iron or steel products production process*

Iron or steel products are produced from the further processing of crude steel, semi-finished products, as well as other final steel products by all kinds of forming and finishing steps, including: re-heating, re-melting, casting, hot rolling, cold rolling, forging, pickling, annealing, plating, coating, galvanizing, wire drawing, cutting, welding, finishing.

The Implementing Regulation (section 3 Annex II) defines the system boundaries for direct emissions monitoring for the iron or steel products production route, as encompassing:

*“ – All CO<sub>2</sub> emissions from combustion of fuels and process emissions from flue gas treatment, related to production steps applied at the installation, including, but not limited to: re-heating, re-melting, casting, hot rolling, cold rolling, forging, pickling, annealing, plating, coating, galvanizing, wire drawing, cutting, welding and finishing of iron or steel products.”*

Relevant precursors (if used in the process) are: crude steel; pig iron, DRI; ferro-alloys FeMn, FeCr, FeNi; and other iron or steel products. Indirect emissions that result from electricity consumed by the production process should also be monitored.

In line with the above definition of systems boundaries, the following production steps may be regarded as being within the system boundaries of basic steel products:

- Raw material preparation – including pre-heating, re-melting and alloying
- Forming processes for basic steel products – all forming process steps, including casting, hot and cold rolling, shaping by forging, wire drawing
- Finishing activities – all finishing steps including surface treatment (such as pickling, annealing, plating, coating, galvanizing) and further fabrication (cutting, welding, finishing)
- Emissions control – for treating releases to air, water or ground.

The following *Figure 5-13* shows the system boundaries from crude steel to basic steel products.

Figure 5-13: System boundaries of steel products production process

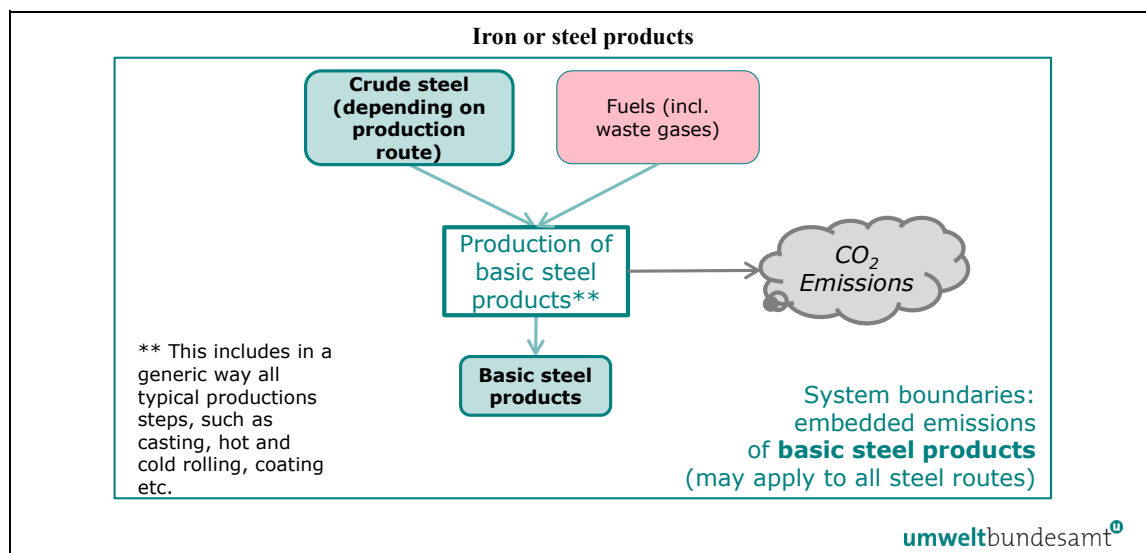

Note that for final iron or steel products that contain more than 5% by mass of other materials, e.g. insulation materials in CN code 7309 00 30 (reservoirs, tanks, vats and similar containers for any material (other than compressed or liquefied gas), of iron or steel, of a capacity exceeding 300 l, lined or heat-insulated), **only the mass of iron or steel shall be reported** as the mass of the goods produced.

Several **case studies** showing how direct and indirect specific embedded emissions (SEE) values are derived for **iron to steel products**, using the mass balance method, and how the embedded emissions of imports into the EU are calculated, are given in section 7.2.2.

## 5.7 Aluminium sector

The textbox below signposts the sector-specific sections in the Implementing Regulation, relevant for the CBAM transitional period.

### Implementing Regulation references:

- **Annex II**, Section 2, Table 1 Mapping of CN codes to aggregated goods categories.
- **Annex II**, Section 3 Production routes, system boundaries, and relevant precursors, as specified in sub-sections: 3.17 – Unwrought aluminium and 3.18 – Aluminium products.

### 5.7.1 Unit of production and embedded emissions

The quantity of declared aluminium goods imported into the EU should be expressed in metric tonnes. As an operator, you should record the quantity of CBAM good(s) produced by the installation or production process, for the purposes of reporting.

<b>Industrial sector</b>	<b>Aluminium</b>
<b>Production unit of goods</b>	Tonnes (metric), reported separately for each type of sector goods, by installation or production process in the country of origin.
<b>Associated activities</b>	Producing unwrought aluminium from alumina, or secondary raw materials (aluminium scrap), by metallurgical, chemical or electrolytic means; manufacture of semi-processed and finished aluminium products.
<b>Relevant greenhouse gases</b>	Carbon dioxide (CO <sub>2</sub> ) and perfluorocarbons (CF <sub>4</sub> and C <sub>2</sub> F <sub>6</sub> )
<b>Direct Emissions</b>	Tonnes (metric) of CO <sub>2</sub> e
<b>Indirect Emissions</b>	Quantity of electricity consumed (MWh), source and emissions factor used to calculate the indirect emissions in Tonnes (metric) of CO <sub>2</sub> or CO <sub>2</sub> e.  <i>To be reported separately during transitional period.</i>
<b>Unit for embedded emissions</b>	Tonnes CO <sub>2</sub> e emissions per tonne of goods, reported separately for each type of good, by installation in the country of origin.

The aluminum sector should account for both direct emissions and indirect emissions in the transitional period. Indirect emissions are to be reported separately<sup>48</sup>. Emissions should be reported in metric tonnes CO<sub>2</sub> equivalent (tCO<sub>2</sub>e) emissions per tonne of output. This figure should be calculated for the specific installation or production process in your country of origin.

Note that a **case study** showing how direct and indirect specific embedded emissions (SEE) values are derived for **aluminium products**, and how the embedded emissions of imports into the EU are calculated, is given in section 7.4.2.

The following sections set out how the system boundaries of aluminium sector goods should be defined, and identify elements of the production process that should be included for the purposes of monitoring and reporting.

### **5.7.2 Definition and explanation of sector goods covered**

The following Table 5-8 lists the relevant goods in scope for the CBAM transitional period in the aluminium industry sector. The aggregated goods category in the left hand column defines groups for which joint ‘production processes’ are to be defined for the purpose of monitoring.

<sup>48</sup> Note that for this sector indirect emissions are only reported during the transitional period (and not during the definitive period).

Table 5-8: CBAM goods in the aluminium sector

<b>Aggregated goods category</b>	<b>Product CN Code</b>	<b>Description</b>
<b>Unwrought aluminium</b>	7601	Unwrought aluminium
<b>Aluminium products</b>	7603 – 7608, 7609 00 00, 7610, 7611 00 00, 7612, 7613 00 00, 7614, 7616	<p>7603 – Aluminium powders and flakes</p> <p>7604 – Aluminium bars, rods and profiles</p> <p>7605 – Aluminium wire</p> <p>7606 – Aluminium plates, sheets and strip, of a thickness exceeding 0,2 mm</p> <p>7607 – Aluminium foil (whether or not printed or backed with paper, paper-board, plastics or similar backing materials) of a thickness (excluding any backing) not exceeding 0,2 mm</p> <p>7608 – Aluminium tubes and pipes</p> <p>7609 00 00 – Aluminium tube or pipe fittings (for example, couplings, elbows, sleeves)</p> <p>7610 – Aluminium structures (excluding prefabricated buildings of heading 9406) and parts of structures (for example, bridges and bridge-sections, towers, lattice masts, roofs, roofing frameworks, doors and windows and their frames and thresholds for doors, balustrades, pillars and columns); aluminium plates, rods, profiles, tubes and the like, prepared for use in structures</p> <p>7611 00 00 – Aluminium reservoirs, tanks, vats and similar containers, for any material (other than compressed or liquefied gas), of a capacity exceeding 300 litres, whether or not lined or heat-insulated, but not fitted with mechanical or thermal equipment</p> <p>7612 – Aluminium casks, drums, cans, boxes and similar containers (including rigid or collapsible tubular containers), for any material (other than compressed or liquefied gas), of a capacity not exceeding 300 litres, whether or not lined or heat-insulated, but not fitted with mechanical or thermal equipment</p> <p>7613 00 00 – Aluminium containers for compressed or liquefied gas</p> <p>7614 – Stranded wire, cables, plaited bands and the like, of aluminium, not electrically insulated</p> <p>7616 – Other articles of aluminium</p>

Source: The CBAM Regulation, Annex I; Implementing Regulation, Annex II.

The aggregated goods categories listed in Table 5-8 include both finished aluminium products and a precursor ‘unwrought aluminium’ that is itself consumed in the production of aluminium goods.

Only input materials listed as relevant precursors to the system boundaries of the production process as specified in the Implementing Regulation are to be considered. Table 5-9 lists the possible precursors by aggregated goods category and production route below.

*Table 5-9: Aggregated goods categories, their production routes and possibly relevant precursors*

<b>Aggregated Goods Category</b>	<b>Relevant precursors</b>
<i>Production route</i>	
Unwrought aluminium	None for primary aluminium
<i>Primary aluminium</i>	For secondary aluminium – unwrought aluminium from other sources, if used in the process <sup>49</sup>
<i>Secondary aluminium</i>	
Aluminium products	Unwrought aluminium (differentiated between primary and secondary aluminium, if known), other aluminium products (if used in the production process).

Unwrought aluminium is produced by several production routes (‘primary aluminium’ for electrolytic smelting, ‘secondary aluminium’ for melting/recycling of scrap) as metal ingots, blocks, billets, slabs or similar. It is defined as a ‘simple good’, as the raw materials (carbon anodes and alumina for primary aluminium, scrap for secondary aluminium) and fuels used in its manufacture are themselves considered to have zero embedded emissions.

The aluminium goods listed above include most types of aluminium product manufactured<sup>50</sup>. Aluminium products are defined as complex goods as they include the embedded emissions from the precursor unwrought aluminium.

The production of aluminium sector goods is by a number of different process routes, outlined below.

### **5.7.3 Definition and explanation of relevant production processes and routes**

The system boundaries of the precursor unwrought aluminium and of aluminium products are distinct and may, under certain conditions, be added together to include all processes directly or indirectly linked to the production processes for these goods, including input activities to, and output activities from the process (see section 6.3).

<sup>49</sup> Note that if the product from secondary aluminium production route contains more than 5% alloying elements, the embedded emissions of the product shall be calculated as if the mass of alloying elements were unwrought aluminium from primary smelting.

<sup>50</sup> Excludes categories CN 7615 for certain household articles and CN 7602 00 aluminium scrap.



Figure 5-14: System boundaries and value chain of aluminium products

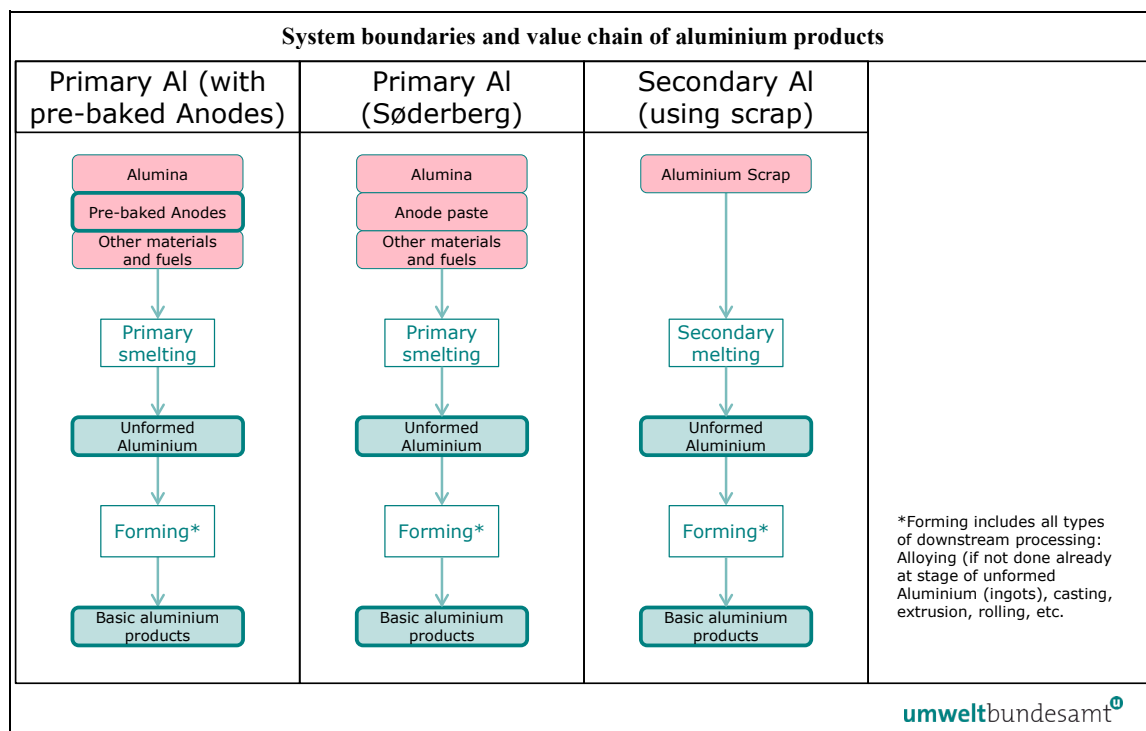

The difference in primary aluminium smelting route in the above diagram is due to the different electrode materials used, i.e. pre-baked or Söderberg anodes.

The relevant emissions that should be monitored for the aluminium sector are detailed in section 7.4.1.1.

#### 5.7.3.1 Unwrought aluminium – Primary (electrolytic) smelting production route

Primary aluminium is produced by the electrolysis of alumina<sup>51</sup> in electrolytic cells. During electrolysis, aluminium is reduced and oxygen from the alumina is liberated and combines with the carbon anode to form carbon dioxide and carbon monoxide – the carbon anodes in the primary aluminium process are therefore continuously consumed during the process.

Primary aluminium cell systems vary according to the type of anode used. The ‘Pre-baked’ electrolytic cell uses multiple pre-baked carbon anodes that must be regularly replaced. The ‘Söderberg’ electrolytic cell uses a single continuous carbon anode, which is self-baked in situ within the cell by means of the heat released during the electrolytic process within the smelter; ‘green’ anode paste briquettes are added at the top while the anode is consumed at the bottom. Molten aluminium is deposited at the cathode and collects at the bottom of the cell, where it is periodically withdrawn by vacuum siphons into crucibles before being transported to the casting plant. At the casting plant molten aluminium is held in holding furnaces for further processing prior to casting metal ingots, blocks, billets, slabs or similar; small quantities of clean commercial scrap may also be added at this stage.

<sup>51</sup> Alumina is purified aluminium oxide produced by beneficiation of bauxite ore via the Bayer process. Production of alumina usually takes place at a different site to primary aluminium production for logistical and power supply reasons

The Implementing Regulation (section 3 Annex II) defines the system boundaries for direct emissions monitoring for the primary (electrolytic) smelting production route, as encompassing:

- “ – CO<sub>2</sub> emissions from the consumption of electrodes or electrode pastes.*
- CO<sub>2</sub> emissions from any fuels used (e.g. for drying and pre-heating of raw materials, heating of electrolysis cells, heating required for casting).*
- CO<sub>2</sub> emissions from any flue gas treatment, from soda ash or limestone if relevant.*
- Perfluorocarbon emissions caused by anode effects monitored in accordance with Section B.7 of Annex III.”*

There are no relevant precursors for this production process. Indirect emissions that result from electricity consumed by the production process should also be monitored.

In line with the above definition of systems boundaries, the following production steps may be regarded as being within the system boundaries of primary aluminium installations:

- Raw material preparation – including storage of various additive constituents.
- Electrolytic cell system for aluminium production process – all steps.
- Casting plant – all steps including holding furnaces, conveying systems, further metal processing (metal treatment, alloying and homogenisation) and casting.
- Emissions control – for treating releases to air, water or ground
- The process materials consumed by the primary aluminium production route – alumina, pre-baked carbon anodes, ‘green’ anode paste briquettes, cryolite and other additives – are treated as raw materials and so have zero embedded emissions.
- Details on the special rules for the aluminium sector for determining emissions from PFCs are given in section 6.5.5 and section 7.4.1.2 of this guidance document, and a **case study** showing how the specific embedded emissions for aluminium sector goods are derived is given in section 7.4.2.

Figure 5-15: System boundaries of the unwrought aluminium – primary smelting production route

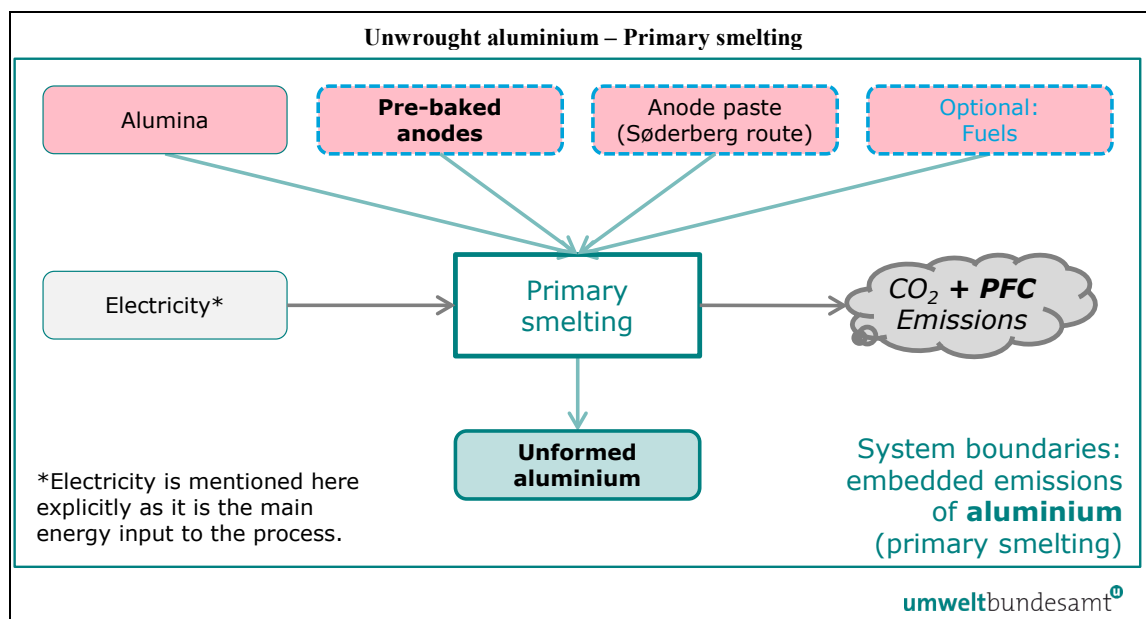

### 5.7.3.2 Unwrought aluminium – Secondary melting (recycling) production route

Secondary aluminium is produced mainly from post-consumer aluminium scrap collected for recycling (although unwrought aluminium may also be separately added). Scrap is sorted according to type (cast or wrought alloy) and the sort of pre-treatment measures required (e.g. de-coating, de-oiling), and is then re-melted in the appropriate type of furnace (typically rotary or reverberatory, but induction furnaces may also be used) before further processing including: alloying, melt treatment (addition of salt or chlorination) and finally casting metal ingots, blocks, billets, slabs or similar. Typical fuels used are natural gas, LPG or fuel oil.

The Implementing Regulation (section 3 Annex II) defines the system boundaries for direct emissions monitoring for the secondary melting (recycling) production route, as encompassing:

- “ – CO<sub>2</sub> emissions from any fuels used for drying and pre-heating of raw materials, used in melting furnaces, in pre-treatment of scrap such as de-coating and de-oiling, and combustion of the related residues, and fuels required for casting of ingots, billets or slabs.
- CO<sub>2</sub> emissions from any fuels used in associated activities such as treatment of skimmings and slag recovery.
- CO<sub>2</sub> emissions from any flue gas treatment, from soda ash or limestone if relevant.”

A relevant precursor is unwrought aluminium from other sources, if used in the process. Indirect emissions that result from electricity consumed by the production process should also be monitored.

In line with the above definition of systems boundaries, the following production steps should be regarded as being within the system boundaries of secondary aluminium:

- Raw material preparation – including sorting, pre-treatment (de-coating, de-oiling), drying and pre-heating of scrap.
- Furnace system for aluminium production process – all steps, including furnace charging, melting and holding furnaces.
- Casting plant – all steps including holding furnaces, conveying systems, further metal processing (metal treatment, alloying and homogenisation) and casting.
- Emissions control – for treating releases to air, water or ground.

The following *Figure 5-16* shows the system boundaries of the relevant processes for secondary aluminium production.

*Figure 5-16: System boundaries of the Unwrought aluminium – secondary melting production route*

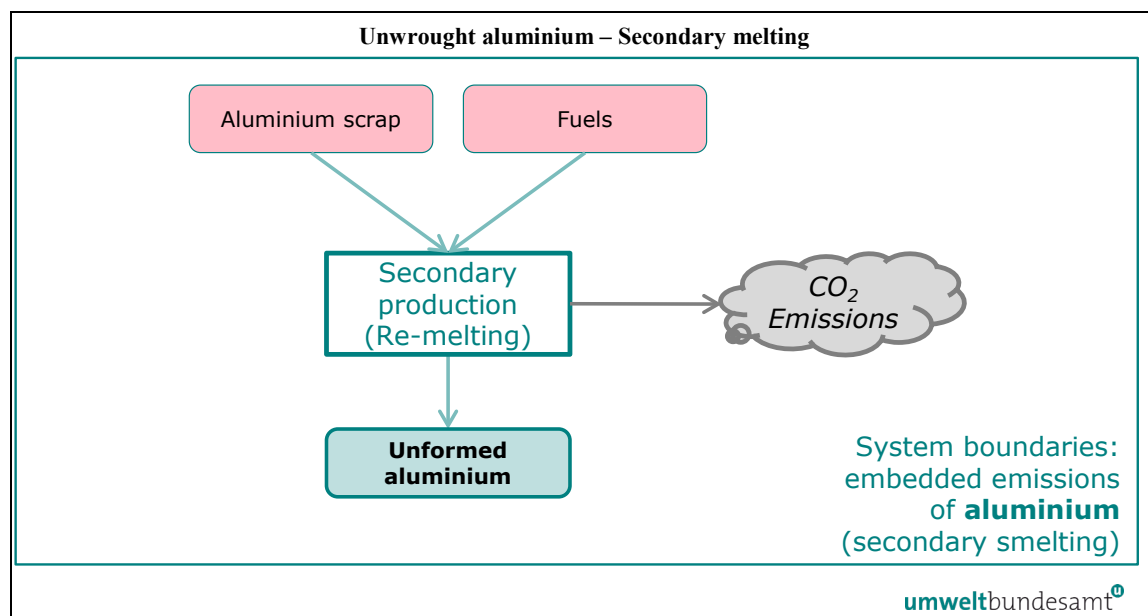

There are no PFC emissions from the secondary aluminium process.

Aluminium scrap is the main material input to the secondary melting production route. Scrap (whether pre-consumer or post-consumer) is treated as a raw material and so has zero embedded emissions.

Note that where the product of this process contains more than 5% alloying elements, the embedded emissions of the product shall be calculated as if the mass of alloying elements were unwrought aluminium from primary smelting.

### 5.7.3.3 Aluminium products production process

Aluminium products are produced by the further processing of precursor unwrought aluminium (alloyed or un-alloyed). Aluminium products are produced by a variety of forming processes including extrusion, casting, hot and cold rolling, forging and drawing. Extrusion is a common process used to produce aluminium profiles. Hot and cold rolling may be used to produce plate, sheet and foil. Casting may be used to produce complex forms.

The Implementing Regulation (section 3 Annex II) defines the system boundaries for direct emissions monitoring for the aluminium products production route, as encompassing:

*“ – All CO<sub>2</sub> emissions from fuel consumption in processes forming aluminium products, and flue gas cleaning.”*

Relevant precursors are unwrought aluminium, if used in the production process (primary and secondary aluminium should be treated separately, if data is known, as each has different embedded emissions), and aluminium products, if used in the production process. Indirect emissions that result from electricity consumed by the production process should also be monitored.

In line with the above definition of systems boundaries, the following production steps should be regarded as being within the system boundaries of basic aluminium products installations:

- Raw material preparation – including pre-heating, re-melting and alloying.
- Forming processes – all forming process steps for basic aluminium products, including (but not limited to): extrusion, casting, hot and cold rolling, forging, drawing.
- Finishing activities – including sizing, annealing, surface preparation and treatment and further fabrication.
- Emissions control – for treating releases to air, water or ground.

The following *Figure 5-17* shows the system boundaries of the relevant processes for aluminium products.

Figure 5-17: System boundaries of Aluminium products production process

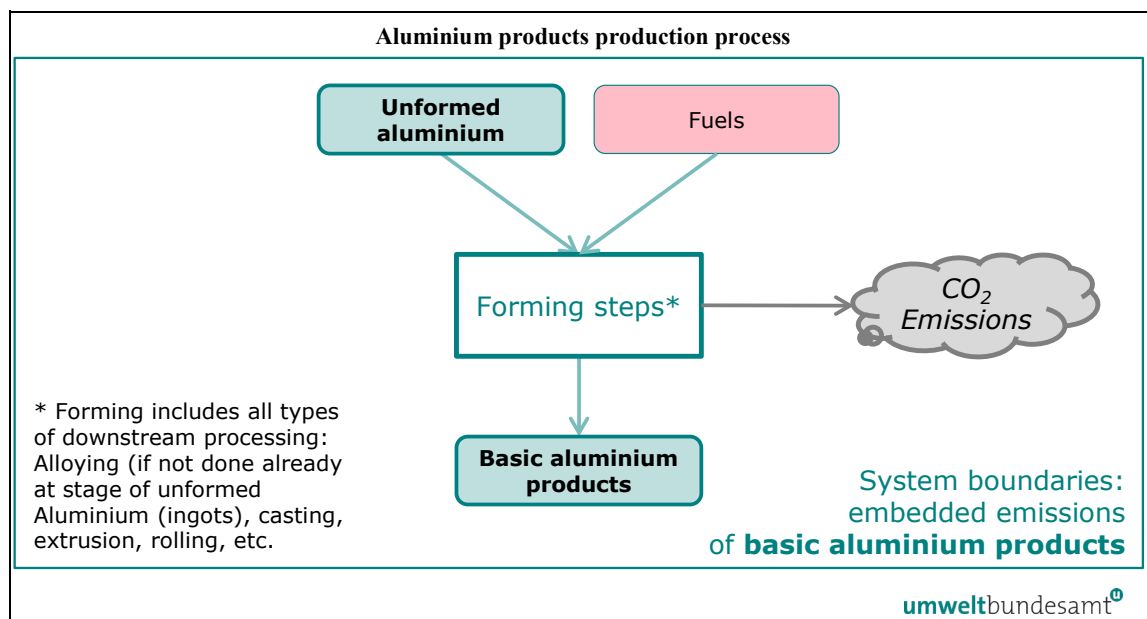

There are no PFC emissions resulting from aluminium products forming processes.

Note that where the product of this process contains more than 5% alloying elements, the embedded emissions of the product should be calculated as if the mass of alloying elements were unwrought aluminium from primary smelting.

Also note that for products that contain more than 5 % by mass of other materials, e.g. insulation materials in CN code 7611 00 00 only the mass of aluminium shall be reported as the mass of the goods produced.

A **case study** showing how the specific embedded emissions for aluminium sector goods are derived is given in section 7.4.2.

## 6 MONITORING AND REPORTING OBLIGATIONS

This section contains all of the rules necessary for monitoring and calculating embedded emissions during the transitional period. It is structured as follows:

- Section 6.1 contains **definitions** and principles.
- Section 6.2 explains the **concept of embedded emissions** (6.2.1), before it provides the **calculation rules** (6.2.2) in three steps:
  - **Installation-level** monitoring (6.2.2.1).
  - **Attributing the emissions data to production processes** within the installation (6.2.2.2).
  - **Calculation of specific embedded emissions** from the attributed emissions of the processes, the embedded emissions of the precursor, and the activity level of the production process.
- **How to define the production processes** of the installation and their **system boundaries** is the topic of section 6.3.
- Section 6.4 deals with the planning of the monitoring methodology. This includes setting up the MMD (**monitoring methodology documentation**), how to select the **best available data sources** and the possibilities to **limit monitoring costs**. The section also provides advice on setting up a **control system** for ensuring correct data.
- Section 6.5 is a central part of this guidance. It gives guidance on the **eligible monitoring approaches** to monitor direct emissions at installation level, with the following sub-structure, reflecting the “building-block” character of allowed approaches:
  - Section 6.5.1: **Calculation-based methodology**
    - Calculation formulae and parameters are explained in 6.5.1.1 (standard method) and 6.5.1.2 (mass balance).
    - Rules for determining **activity data** (i.e. quantities of fuels and materials used) are given in section 6.5.1.3.
    - The rules for determining ‘**calculation factors**’ (i.e. information on properties and composition of the fuels and materials used) are subject of 6.5.1.4. These methods include the selection of appropriate standard values, are the use of **laboratory analyses**, for which basic requirements are discussed.
  - In section 6.5.2, the measurement-based methodology is described, i.e. how to use CEMS (**continuous emissions monitoring systems**). This is in particular necessary for **N<sub>2</sub>O emissions**.
  - The conditions to use **other methods, in particular from other carbon pricing schemes**, are explained in section 6.5.3.
  - Requirements for **accounting biomass** emissions as zero in all the above methods are outlined in section 6.5.4, which is supplemented by additional information in Annex E.
  - The monitoring of **PFCs** (perfluorocarbon emissions) is explained in section 6.5.5.

- As the last element of installation-level monitoring, section 6.5.6 outlines basic elements of ‘transferred CO<sub>2</sub>’ monitoring, which is the link to future **CCS and CCU rules**.
- **Indirect emissions** of an installation and their monitoring requirements are explained in section 6.6.
- The rules for **attributing emissions to production processes** are the subject of section 6.7 containing the following detailed rules:
  - General rules for monitoring: 6.7.1,
  - **Flows of (measurable) heat** and the related emissions: 6.7.2,
  - **Electricity** and respective emissions: 6.7.3,
  - Rules for the combined production of heat and electricity (**cogeneration, CHP**) to supplement the two previous sections are explained in section 6.7.4.
  - **Waste gases** and their emission attribution rules: 6.7.5,
- **Calculation of embedded emissions from attributed emissions**: Relevant guidance is found in section 6.8 with the following sub-sections:
  - **Rules on goods produced** (quality and activity levels) are found in 6.8.1.
  - The rules for monitoring quality and quantity of **precursor materials** are discussed in section 6.8.2.
- The monitoring rules are concluded by explaining what can be done if the monitoring fails, i.e. data gaps occur, or if some information could not be obtained within the required time frame (section 6.9):
  - **Use of default values** of specific embedded emissions provided by the European Commission is discussed in section 6.9.1.
  - For indirect emissions, i.e. **default values for the emission factor of electricity**, is described in section 6.9.2.
  - Guidance on **closing of minor data gaps** in everyday monitoring activities is given in section 6.9.3.
- Collecting data on a **carbon price** due in the country of origin (as possible rebate from the CBAM obligation) is the topic of section 6.10.
- Finally, section 6.11 explains the **reporting template**, i.e. the template which the European Commission provides for the communication between operators of installations producing CBAM goods and the EU importers in order to provide the data the latter require for producing the ‘quarterly CBAM reports’, i.e. for complying with the CBAM Regulation. That template is also proposed for communication between operators producing complex goods and their suppliers of precursor materials.



## 6.1 Definitions and scope of emissions covered in the CBAM

In order to complete the relevant calculations, it is important to understand the precise meanings of terms used in these calculations. In addition to the general definitions introduced in Section 4.2, this section presents additional terms used in the following sections of this guide.

### 6.1.1 Installation, production process and production routes

The following hierarchical approach of definitions applies:

- **‘Installation’** means a stationary technical unit where a production process is carried out.
- **‘Production process’** means the parts of an installation in which chemical or physical processes are carried out to produce goods under an aggregated goods category defined in Table 1 of Section 2 of Annex II to the Implementing Regulation, and its specified system boundaries regarding inputs, outputs and corresponding emissions.
- **‘Aggregated goods category’** is *implicitly* defined in the Implementing Regulation by listing the relevant aggregated goods categories and all the goods identified by their CN codes in Table 1 of Section 2 of Annex II.
- **‘Production route’** means a specific technology used in a production process to produce goods under an aggregated goods category.

From these definitions it can be deduced that an installation may consist of one or more production processes. For the purpose of the CBAM only those production processes are relevant that are listed in Annex II Section 2 of the Implementing Regulation. If your installation carries out other production processes, it is your choice to include them in your monitoring methodology or not. In both cases the rules for attributing the emissions to the CBAM-relevant processes will work.

One production process usually relates to one group of CBAM goods produced (the ‘aggregated goods categories’). However, in some case more than one production route exists for producing these goods. If more production routes co-exist at your installation for the same aggregated goods category, they may be jointly monitored using one production process and its respective system boundaries.

From the above, the short summary is: An installation can consist of more than one production process, and production processes can consist of more than one production route. The “attributed emissions” are always calculated at the production process level. Note that some **further rules** exist for defining production processes and their system boundaries, as discussed in Section 6.3.

### 6.1.2 Activity level, quantity of goods produced

In a given reporting period, **‘activity level’** is the total quantity of goods produced within a production process meeting a particular CN product specification for that good, expressed in tonnes or MWh for electricity. For the purpose of determining the activity level of a production process, the quantity of all goods under all CN codes which represent an ‘aggregated goods category’ are added up.

The activity level for an installation or production process should take into account **saleable product**<sup>52</sup>, including any product used directly as **precursor** in **another production process** for producing other products (termed ‘relevant precursor material’).

In order to **avoid any double counting** of production, you should only consider the final products leaving the system boundaries of the production process. Product that is returned to the same process (where the production of precursors is included in the same production process) as well as any waste or scrap is excluded from the total.

In reporting the activity level for goods, you should also take into account any special provisions given in Annex II, Section 3 of the Implementing Regulation for specific production processes or production routes. These are also referred to for each sector as relevant in section 7.

### 6.1.3 *Direct and indirect embedded emissions*

During the transitional period you need to account for both ‘direct emissions’<sup>53</sup> and ‘indirect emissions’<sup>54</sup>, in reporting the embedded emissions of the goods produced at your installations. In this context:

- **Direct emissions** include combustion and process emissions for your installation, but also emissions produced during the production of heat consumed in your installation, in case the installation receives heat from adjacent installations or from a district heating network.
- **Direct attributed emissions** are the emissions attributed to the relevant production process producing goods at your installation, based on your installation’s direct emissions, emissions from relevant heat flows, material flows, waste gases (if relevant).
- **Direct embedded emissions** of the goods produced are calculated from the direct attributed emissions of the production process by adding the embedded emissions of any relevant precursor materials used in this production process.
- **Specific direct embedded emissions:** These are the direct embedded emissions of the goods produced, divided by the activity level of the production process. The result is expressed as tonne CO<sub>2e</sub> per tonne of product.
- **Indirect emissions** include emissions related to the **electricity consumed** at your installation. Note that if your installation produces itself electricity, the fuels consumed in the electricity production count as *direct* emissions of the installation. But electricity production is considered a separate production process, i.e. those direct emissions are *not attributed* to direct attributed emissions of any goods produced in this installation.

---

<sup>52</sup> I.e. products that meet the product specification for an aggregated CN goods category listed in the Implementing Regulation.

<sup>53</sup> ‘Direct emissions’ mean emissions from the production processes of goods including emissions from the production of heating and cooling consumed during the production processes, regardless of the location of the production of the heating and cooling;

<sup>54</sup> ‘Indirect emissions’ mean emissions from the production of electricity, which is consumed during the production processes of goods, regardless of the location of the production of the consumed electricity.

- **Indirect attributed emissions** are the indirect emissions attributed to the relevant production process producing goods at your installation.
- **Indirect embedded emissions** of the goods produced are calculated from the indirect attributed emissions of the production process by adding the indirect embedded emissions from any relevant precursors used in the production process.
- **Specific indirect embedded emissions:** These are the indirect embedded emissions of the goods produced, divided by the activity level of the production process. The result is expressed as tonne CO<sub>2</sub>e per tonne of product.
- **(Specific) total embedded emissions:** The sum of (specific) direct and indirect embedded emissions.

Your approach used to monitor direct and indirect emissions should reflect the range of ‘emission sources’ and ‘source streams’ (for definition see section 6.2.2.1) that need to be covered for your individual installation and its production routes.

### **Embedded emissions in precursor goods**

You should include the embedded emissions in precursor goods (both direct and indirect emissions, as above) if relevant in the calculation of total embedded emissions for a final good, making it a ‘complex good’. The embedded emissions of the relevant precursor goods<sup>55</sup> are added to attributed emissions of the complex good.

The inclusion of embedded emissions of precursor goods is necessary to ensure comparability of carbon costs under the EU ETS and the CBAM. The relevant greenhouse gas emissions correspond to those greenhouse gas<sup>56</sup> emissions covered also by Annex I to the EU ETS Directive<sup>57</sup>, namely carbon dioxide (CO<sub>2</sub>) for all sectors, and additionally nitrous oxide (N<sub>2</sub>O) for fertilizers and perfluorocarbons (PFCs) for aluminium.

### **Embedded emissions outside of the operator’s control**

Where you (as an operator) are receiving electricity, heat or precursor goods from outside of the installation, for use in your installation’s production processes, you should use the most recent data available from their supplier for the purpose of determining the embedded emissions of your CBAM goods. Such emissions-related data include:

- Indirect emissions from imported grid electricity;
- Emissions from electricity and heat imported from other installations;
- Direct and indirect emissions of precursors received from other installations.

---

<sup>55</sup> Where a precursor is itself a complex good, this process is repeated recursively until no more precursors are relevant.

<sup>56</sup> ‘Greenhouse gases’ mean greenhouse gases as specified in Annex I to the CBAM Regulation in relation to each of the goods listed in that Annex;

<sup>57</sup> Directive 2003/87/EC

### 6.1.4 Units for reporting embedded emissions

The unit used for reporting embedded greenhouse gas is ‘tonne of CO<sub>2</sub>e<sup>58</sup>’, which means one metric tonne of carbon dioxide (‘CO<sub>2</sub>’), or an amount of any other greenhouse gas listed in Annex I to the CBAM Regulation with an equivalent (‘e’) global warming potential<sup>59</sup>; i.e. where relevant, N<sub>2</sub>O and PFCs emissions should be converted to their ‘tCO<sub>2</sub>e’ value.

For reporting purposes embedded emissions data should be rounded to whole tonnes CO<sub>2</sub>e over the reporting period. Parameters used to calculate the reported embedded emissions should be rounded to include all significant digits, to a maximum of 5 decimal places. The level of rounding required for parameters used in such calculations will depend on the accuracy and precision of the measurement equipment used.

## 6.2 How to determine embedded emissions

### 6.2.1 The concept

The concept of embedded emissions, for the purposes of the CBAM, is based on, **but not** fully aligned with the principles and requirements for a carbon footprint of products (CFP). A CFP is usually understood as an amount of GHG emissions (expressed as kg or t CO<sub>2</sub>e) per *declared unit*, (e.g. a tonne of good) based on a life cycle perspective covering, all significant emissions from upstream and downstream processes (called life cycle stages), from mining and production to transport, use and end-of-life.

The difference from the CFP scope is because the CBAM is intended to cover the same emissions as would be covered by the EU ETS if the production were situated in the EU. The system boundaries of emissions covered by the EU ETS, and therefore the CBAM, are **narrower than those in a CFP**. Downstream emissions (emissions from the use and end-of-life) of the products are outside the scope of the EU ETS and the CBAM. Emissions included from transport of materials between sites and from processes further upstream are not included either. *Figure 6-1* summarizes this situation graphically.

For the purpose of determining CBAM embedded emissions at a product level, the starting point are emissions of an installation. The installation’s emissions are split (‘attributed’) to emissions of its production processes. Then any relevant embedded emissions of precursor materials are added, and the result is divided by the activity level of each production process, thereby resulting in ‘specific embedded emissions’ of the goods resulting from the production process. These considerations are reflected in the definitions of direct and indirect emissions, as set out in the CBAM Regulation, and in its Annex IV which lays down the basic calculation approach, which in particular requires taking into account precursor materials. The details of this approach are elaborated in the Implementing Regulation, in particular Annexes II and III, and explained in this document.

---

<sup>58</sup> ‘tonne of CO<sub>2</sub>e’ means one metric tonne of carbon dioxide (‘CO<sub>2</sub>’), or an amount of any other greenhouse gas listed in Annex I to the CBAM Regulation with an equivalent global warming potential

<sup>59</sup> In line with the EU ETS legislation, the 100-year GWP values of the 5<sup>th</sup> IPCC Assessment Report (AR5) are used.

Figure 6-1: Comparison of product environmental footprint, product carbon footprint, and the specific partial carbon footprint that is to be used for determining embedded emissions in the CBAM.

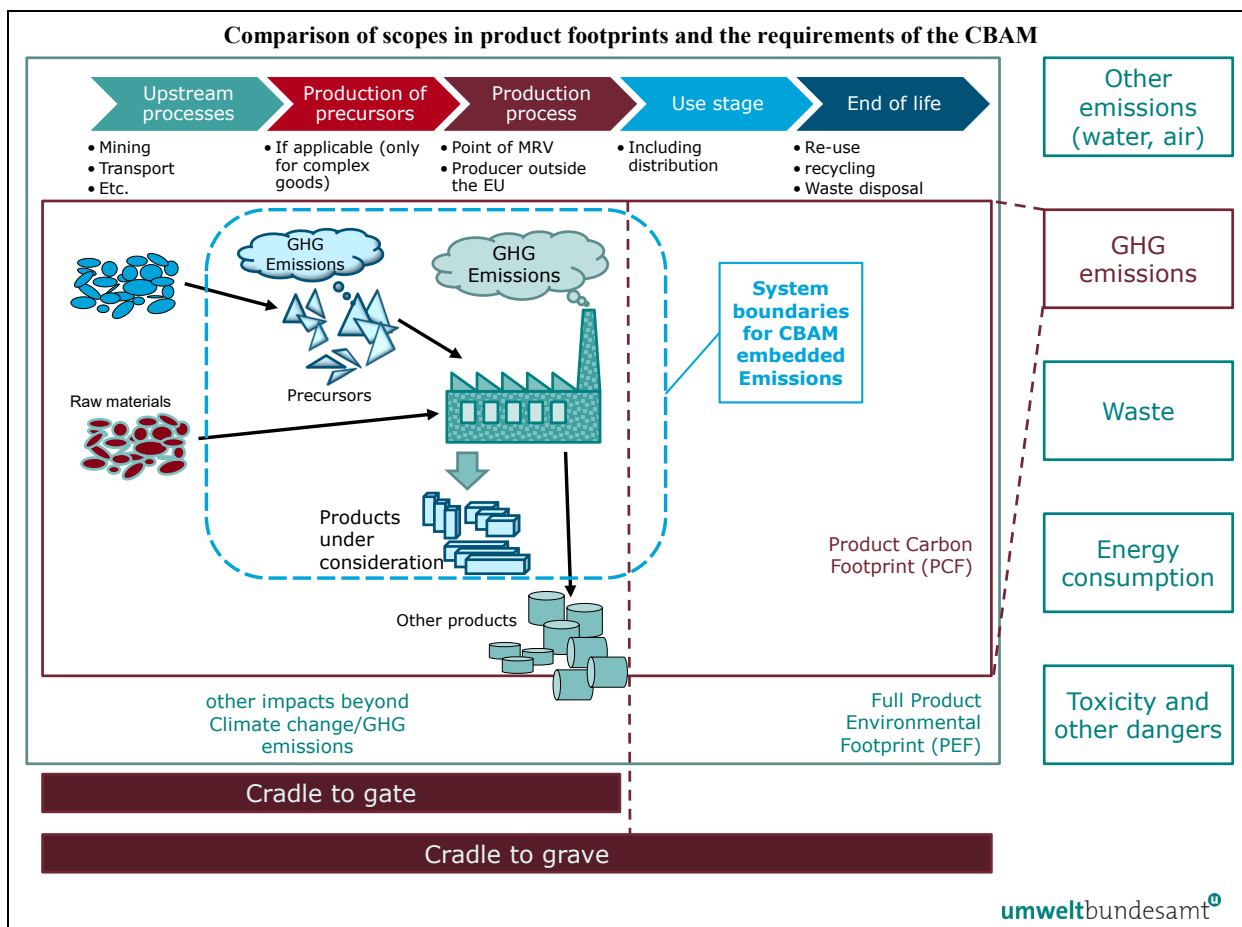

## 6.2.2 From installation's emissions to goods' embedded emissions

This section outlines the steps to follow to determine the embedded emissions of a good; first explaining the concept, then the attribution of emissions and finally the calculation of the embedded emissions.

The textbox below signposts the key sections in the Implementing Regulation for this purpose, relevant for the CBAM transitional period.

### Implementing Regulation references:

**Annex II**, Section 3 Production routes, system boundaries, and relevant precursors

**Annex III**, Section A Definitions and principles, in particular, sub-sections A.4. Division of installations into production processes

To aid understanding of the monitoring rules contained in Annex III to the Implementing Regulation, this section explains some terms and concepts. If you are experienced with emissions monitoring, you may skip this section. This might be the case for example if your installation is located in a jurisdiction where a carbon pricing system (e.g. an emissions trading system) or a mandatory monitoring rule for GHGs applies, or if your

installation performs GHG reduction projects under an internationally accepted certification scheme with verification.

The approach of the CBAM is “top-down” as follows:

- First the emissions of the installation are determined (details in section 6.5).
- Then the installation is split into ‘production processes’ which produce the (groups of) goods for which the embedded emissions should be determined. The total installation’s emissions are ‘attributed’ to these production processes using the concepts described in section 6.2.2.2. The rules for defining boundaries of production processes are found in section 6.3.
- The attribution of emissions to production processes is a relatively complex task, because the rules had to be designed in a way that different installation designs are treated as equally as possible. Such different situations involve e.g.:
  - The different ways of heat supply: Heat can be produced directly within the process from fuels or electricity, it can be received from other parts of the installation (e.g. from a central boiler, a CHP unit, a steam grid with various heat sources, from exothermal chemical reactions) or from outside the installation (from a known boiler house or CHP unit, or from a district heating network). A certain amount of emissions should be attributed to any such heat. Therefore, attribution of emissions to production processes requires the monitoring of relevant heat streams (for rules see section 6.7.2).
  - Differences in electricity supply: It requires the monitoring of electricity quantities (rules see section 6.7.3) exported from production processes (the import is relevant for the determination of indirect emissions). For every type of electricity there are common elements (such as the emission factor).
  - Finally, so-called ‘waste gases’ have to be taken into account, i.e. gases that have some heating value due to incompletely oxidised fuels and which occur as result of some production processes (e.g. the blast furnace of a steel plant) are treated with some special rules which evolved during the development of EU ETS benchmarks (see section 6.7.5).
- The next step is the addition of embedded emissions of the relevant precursor materials. The ‘attributed emissions’ of the production process only give the emissions of the CBAM good as if it were a ‘simple good’. However, if precursors are identified as relevant in Annex II, section 3 of the Implementing Regulation, i.e. if the good is a ‘complex good’, the precursor’s own embedded emissions need to be added. Only thereafter it is correct to use the term ‘embedded emissions’ of the goods produced. The concept is further described in section 6.2.2.3, and rules for monitoring of precursor-related data are given in section 6.8.2.
- Finally, the embedded emissions as determined under the previous step still relate to the total production process and the total quantity of goods produced therein, over the whole ‘reporting period’, usually a (calendar) year. However, the importers need to report the embedded direct and indirect emissions *per tonne of product*, which are the so-called ‘specific (direct or indirect) embedded emissions’. Those specific embedded emissions are determined by dividing the process-level embedded emissions by the ‘activity level’, i.e. the total quantity (in

tonnes) of the goods produced. Rules for determining the activity level are discussed in section 6.1.2.

Note: **The Commission's template for the communication between operators and importers is designed to perform most of the relevant calculations automatically** when the necessary data is input. It is, therefore, a valuable tool for you as an operator to provide all the data that importers are obliged to report, as it will help you to avoid incomplete data and to reduce calculation errors to a large extent. Therefore, it is highly recommended to use this template. It is described in section 6.11



### 6.2.2.1 Concepts of installation-level GHG monitoring

Like other carbon pricing schemes, Annex III, section B, of the Implementing Regulation for the CBAM provides several monitoring methodologies like a building block system, so that operators can choose for their installation the best possible monitoring approach, where “best” includes elements such as accuracy, but also cost efficiency. For the latter purpose, it is often beneficial to choose monitoring methods which are already available at the installation, e.g. measuring instruments that are used for process control, or for confirming quantities of materials and fuels received or sold.

Here we use Figure 6-2 to introduce some of the main concepts and terms which are then used when discussing the Implementing Regulation's detailed monitoring rules in section 6.5 of this document.

Figure 6-2: Example of a simple installation for explaining basic monitoring concepts (please see main text for more information).

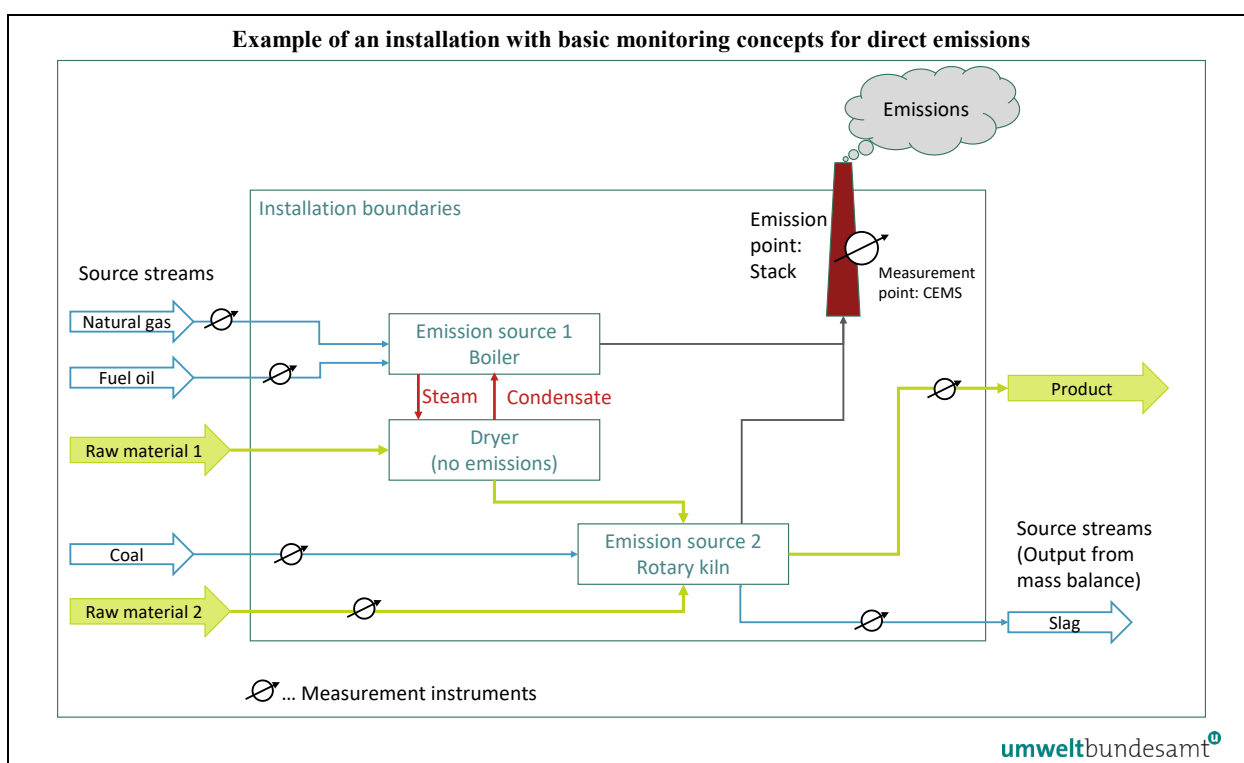

The fictitious example installation consists of a dryer in which raw material 1 is dried using steam from a boiler. This material is considered not to contribute to the emissions. Another raw material (e.g. limestone) is calcined in a rotary kiln, where CO<sub>2</sub> is set free from a carbonate. A mixture of the calcined materials is considered the only product of this installation, which consequently has only one production process. The following elements can be shown using *Figure 6-2*.

### Definitions:

- **‘Source stream’**<sup>60</sup>: The fuels or materials containing carbon that can be released by combustion or other chemical processes are summarised by the term ‘source stream’. In case that outputs such as products, by-products or wastes contain significant amounts of carbon, they would also qualify as ‘source streams’, and the ‘mass balance’ approach would take these into account by subtracting their carbon amounts from the emissions. In the *Figure 6-2*, input source streams are the fuels natural gas, fuels oil and coal, furthermore the material “raw material 2”, and potentially the products and the slag, if they contain relevant amounts of carbon.
- **‘Emission source’**<sup>61</sup>: Single process units, such as the boiler and the kiln are termed ‘emission sources’. Note that also the stack could be considered an emission source. It is, however, more consistent to term that an **‘emission point’**, which is a place where a Continuous Emissions Measurement System (CEMS) can be installed at a ‘measurement point’ (which is the location of the CEMS).

### Monitoring approaches:

Annex III to the CBAM Implementing Regulation allows the following monitoring approaches at installation level:

- **Calculation-based approach** in two variants (more details are given in section 6.5.1.1):
  - **Standard method**: This requires the quantity (**‘activity data’**) of all the fuels and input materials to be determined, as well as some qualitative information on these fuels and materials, in particular the **‘emission factor’**. Should some carbon not be emitted (e.g. if some carbon remains in the ash of coal), then this is taken into account by the **‘oxidation factor’**. Other incomplete processes are taken into account by a **‘conversion factor’**. In the example of *Figure 6-2* the measurement instruments indicate where quantities of the source streams are determined for this purpose.
  - **Mass balance**: In this case, the carbon quantities of all fuels, input materials as well as output materials are determined, again by determining their quantities as well as their **carbon content**.

---

<sup>60</sup> Definition in the Implementing Regulation: ‘source stream’ means any of the following:  
(a) a specific fuel type, raw material or product giving rise to emissions of relevant greenhouse gases at one or more emission sources as a result of its consumption or production;  
(b) a specific fuel type, raw material or product containing carbon and included in the calculation of greenhouse gas emissions using a mass balance method;

<sup>61</sup> Definition in the Implementing Regulation: ‘emission source’ means a separately identifiable part of an installation or a process within an installation, from which relevant greenhouse gases are emitted.



- What is not shown in *Figure 6-2*: If a source stream contains biomass, the respective CO<sub>2</sub> emissions may be zero-rated under certain conditions. This is achieved by multiplying the ‘**preliminary emission factor**’ by a term “1 – **biomass fraction**”, so that in case of pure fossil fuel, the resulting emission factor is identical to the preliminary emission factor, while it is zero for pure biomass. However, only biomass complying with certain **sustainability criteria** is eligible for such “zero-rating.
- **Measurement-based approach** (more details are given in section 6.5.2): Instead of monitoring separately all the source streams, it may sometimes be desirable to perform monitoring by a single operation. In *Figure 6-2* the stack receives all emissions from all emission sources (and consequently from all source streams. If a CEMS is installed here, it can be used to monitor the whole installation’s emissions.
- Note that for avoiding double counting, there is a **choice to be made** between calculation-based and measurement-based approach. Both can co-exist at an installation for different parts of the installation, or for mutual corroboration of the same emissions data. However, you, as the operator, have to make a choice which of the methods to use in a way that neither gaps nor double counting in your monitoring occur. For making this choice, section 6.4.4 gives further advice.
- **Other approaches**: The Implementing Regulation acknowledges that some operators need time to adapt to the new requirements. Therefore, under some conditions, other monitoring approaches are allowed. Section 6.5.3 provides further information.

### Measurement instruments and analyses:

*Figure 6-2* indicates symbolic measurement instruments. Some further clarification is justified:

- Measurements for determining quantities of fuels and materials can be carried out basically in two ways: **Continual** metering (such as using a gas meter or a liquid flow meter for oil), which requires only reading of the incremental amounts consumed, e.g. monthly. On the other hand, **batch-wise** metering is applied e.g. where every truck load, or train or ship loads are weighted separately. Such quantities are usually stored at the installation before use. Therefore, **stocks** need to be taken into account at the beginning and end of the reporting period. In the figure, it can be assumed that natural gas is metered continually, while fuel oil, coal and the raw materials are metered batch-wise.
- For selecting a monitoring approach, it is relevant whether an instrument or sampling point is **under the operator’s control** or under somebody else’s control. In the example of *Figure 6-2*, the meter for natural gas is indicated to be outside the installation boundaries. This happens often, that the metering is done by the fuel supplier. Therefore, official **information such as invoices** may be used for determining the quantity of fuels and materials (more details are given in section 6.5).
- Regarding the qualitative information on source streams (the ‘**calculation factors**’), in principle two options exist (more details are given in section 6.5.1.4):
  - Fixed values are used for the emission factor etc.: These can be (internationally accepted) **standard values** from the IPCC guidelines as

presented in Annex V to the Implementing Regulation (and copied in **Annex E** of this guidance), or more suitable national values, literature values etc.

- Values determined by **laboratory analyses**: This approach is appropriate for larger amounts of fuels and materials, or where the quality of the fuel or material is strongly variable. The CBAM Implementing Regulation provides rules on sampling and analyses. In particular, sampling must be carried out in a representative way (the sampling point might correlate with the measuring points for quantity, but this is not always appropriate), and analyses are to be carried out according to accepted standards in laboratories that are competent for the task (ideally demonstrated by accreditation according to ISO/IEC 17025).

Further cases not shown in this picture on which the Implementing Regulation contains rules:

- Special methods for the determination of non-CO<sub>2</sub> greenhouse gases: PFC (perfluorocarbons) in the production of Aluminium (section 6.5.5), and N<sub>2</sub>O in the production of nitric acid and fertilizers (section 7.3.1).
- Rules on ‘transferred CO<sub>2</sub>’ relating to CCU and CCS<sup>62</sup> (more details are given in section 6.5.6.2).

Figure 6-3: Schematic description of system boundaries relevant for the attribution of emissions to a production process (please see main text for more information).

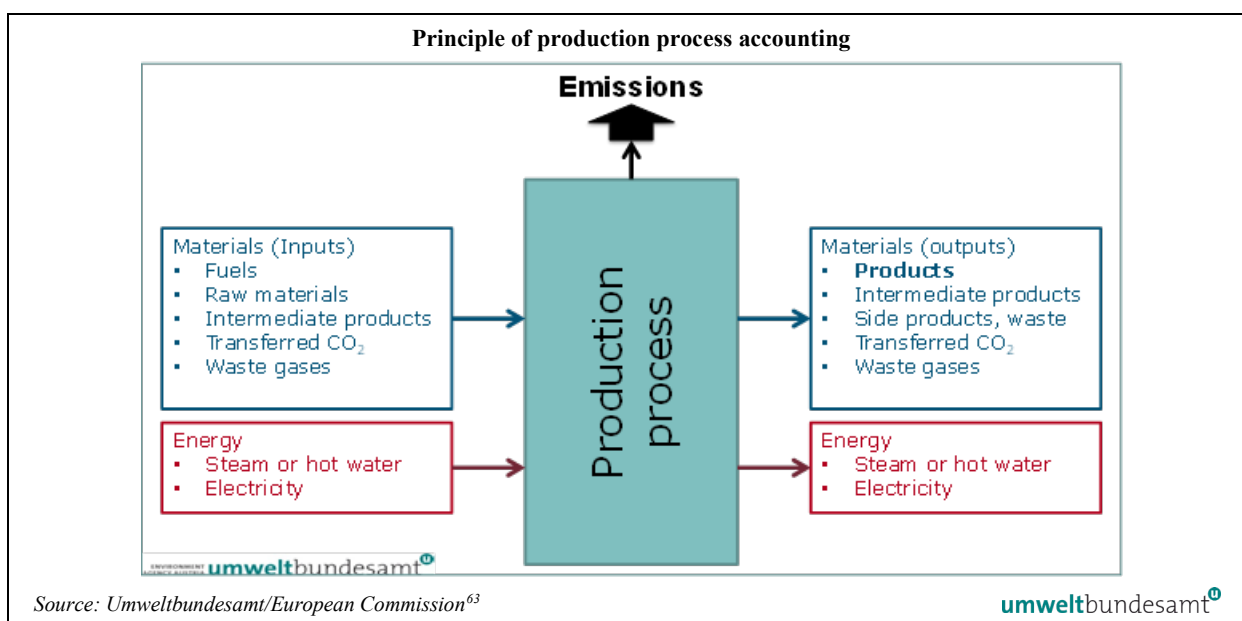

<sup>62</sup> Carbon Capture and Utilisation, and Carbon Capture and (geological) Storage

<sup>63</sup> Guidance document No. 5 on monitoring for free allocation in the EU ETS: [https://climate.ec.europa.eu/system/files/2019-02/p4\\_gd5\\_mr\\_guidance\\_en.pdf](https://climate.ec.europa.eu/system/files/2019-02/p4_gd5_mr_guidance_en.pdf)

### 6.2.2.2 Attribution of emissions to production processes

As has been said above in section 6.2.2, the attribution of emissions is a complex task. This is because a production process's system boundaries in principle form an energy and mass balance, from which the result are the attributed emissions, as sketched in *Figure 6-3*.

#### Attributed direct emissions

For calculating attributed direct emissions of a production process, the relevant formula is given in section F.1 of Annex III to the Implementing Regulation. It is applied using total figures over the whole reporting period for the parameters given in the equation as follows:

$$AttrEm_{Dir} = DirEm^* + Em_{H,imp} - Em_{H,exp} + WG_{corr,imp} - WG_{corr,exp} - Em_{el,prod}$$

Where  $AttrEm_{Dir}$  is calculated to have a negative value, it shall be set to zero.

This formula provides a guideline which parameters need to be monitored whenever an installation consists of more than one production process, or where heat supply is separated, or where waste gases or electricity production are found in an installation. Note that details will be given in sections 6.7.2 (heat), 6.7.3 (electricity) and 6.7.5 (waste gases).

Parameter explanations are as follows:

---

$AttrEm_{Dir}$	are the attributed direct emission of the production process over the whole reporting period, expressed in t CO <sub>2</sub> e;
$DirEm^*$	are the directly attributable emissions from the production process, determined for the reporting period using the rules provided in Section B of Annex III to the Implementing Regulation, and the following rules:  Measurable heat: Where fuels are consumed for the production of measurable heat which is consumed outside the production process under consideration, or which is used in more than one production process (which includes situations with imports from and exports to other installations), the fuels' emissions are not included in the directly attributable emissions of the production process, but added under the parameter $Em_{H,import}$ in order to avoid double counting.  Waste gases:  The emissions caused by waste gases produced and fully consumed within the same production process are included in $DirEm^*$ .  The emissions from the combustion of waste gases exported from the production process are fully included in $DirEm^*$ irrespective of where they are consumed. However, for exports of waste gases the term $WG_{corr,export}$ shall be calculated.  Emissions from the combustion of waste gases imported from other production processes are not taken into account in $DirEm^*$ . Instead the term $WG_{corr,import}$ shall be calculated;

---

---

$Em_{H,imp}$

are the emissions equivalent to the quantity of measurable heat imported to the production process, determined for the reporting period using the rules provided in Section C of Annex III to the Implementing Regulation, and the following rules:

Emissions related to measurable heat imported to the production process include imports from other installations, other production processes within the same installation, as well as heat received from a technical unit (e.g. a central power house at the installation, or a more complex steam network with several heat producing units) that supplies heat to more than one production process.

Emissions from measurable heat shall be calculated using the following formula:

$$Em_{H,imp} = Q_{imp} \cdot EF_{heat}$$

Where:

$EF_{heat}$  is the emission factor for the production of measurable heat determined in accordance with Section C.2 of Annex III to the Implementing Regulation, expressed in t CO<sub>2</sub>/TJ and

$Q_{imp}$  is the net heat imported to and consumed in the production process expressed in TJ;

---

$Em_{H,exp}$

are the emissions equivalent to the quantity of measurable heat exported from the production process, determined for the reporting period using the rules provided in Section C of Annex III to the Implementing Regulation. For the exported heat either the emissions of the actually known fuel mix in accordance with Section C.2 of that Annex shall be used, or – if the actual fuel mix is unknown – the standard emission factor of fuel most commonly used in the country and industrial sector, assuming a boiler efficiency of 90%.

Heat recovered from electricity-driven processes and from nitric acid production shall not be accounted;

---

$WG_{corr,imp}$

are the attributed direct emissions of a production process consuming waste gases imported from other production processes, corrected for the reporting period using the following formula:

$$WG_{corr,imp} = V_{WG} \cdot NCV_{WG} \cdot EF_{NG}$$

Where:

$V_{WG}$  is the volume of the waste gas imported;

$NCV_{WG}$  is the net calorific value of the waste gas imported, and

$EF_{NG}$  is the standard emission factor of natural gas as given in Annex VIII to the Implementing Regulation;

---

---

$WG_{corr,exp}$  are the emissions equivalent to the quantity of waste gases exported from the production process, determined for the reporting period using the rules provided in Section B of Annex III to the Implementing Regulation, and the following formula:

$$WG_{corr,exp} = V_{WG,exp} \cdot NCV_{WG} \cdot EF_{NG} \cdot Corr_{\eta}$$

Where:

$V_{WG,exported}$  is the volume of waste gas exported from the production process;

$NCV_{WG}$  is the net calorific value of the waste gas;

$EF_{NG}$  is the standard emission factor of natural gas as given in Annex VIII to the Implementing Regulation,

$Corr_{\eta}$  is the factor that accounts for the difference in efficiencies between the use of waste gas and the use of the reference fuel natural gas. The standard value is  $Corr_{\eta} = 0,667$ ;

---

$Em_{el,prod}$  are the emissions equivalent to the quantity of electricity produced within the boundaries of the production process, determined for the reporting period using the rules provided in Section D of Annex III to the Implementing Regulation;

---

### Attributed indirect emissions

$$AttrEm_{indir} = Em_{el,cons}$$

Where:

---

$AttrEm_{indir}$  are the attributed indirect emission of the production process over the whole reporting period, expressed in t CO<sub>2</sub>e;

---

$Em_{el,cons}$  are the emissions equivalent to the quantity of electricity consumed within the boundaries of the production process, determined for the reporting period using the rules provided in Section D of Annex III to the Implementing Regulation.

---

### 6.2.2.3 Calculation of embedded emissions of a good

#### Adding precursors' embedded emissions

As has been said above in section 6.2.2, the last step for the determination of embedded emissions is – where applicable, i.e. only for ‘complex goods’ – to add the embedded emissions of any relevant precursors used in a production process to the attributed emissions of the process. However, if you produce precursors yourself in the same installation, and if you can use the ‘bubble approach’ (see section 6.3), the attributed emissions of this ‘bubble’ production process already include the emissions occurring during the production of the precursor. Therefore, **users of the bubble approach need to perform the following calculation only with regard to any precursors purchased in addition to the self-produced ones.**

The following equations apply:

$$EE_{Proc,dir} = AttrEm_{Proc,dir} + \sum_{i=1}^n M_i \cdot SEE_{i,dir}$$

$$EE_{Proc,indir} = AttrEm_{Proc,indir} + \sum_{i=1}^n M_i \cdot SEE_{i,indir}$$

Where

$EE_{Proc,dir}$  are the embedded direct emissions at the level of the production process over the reporting period;

$EE_{Proc,indir}$  are the embedded indirect emissions at the level of the production process over the reporting period;

$AttrEm_{Proc,dir}$  are the attributed direct emissions of the production process as determined in line with section 6.2.2.2 for the reporting period;

$AttrEm_{Proc,indir}$  are the attributed indirect emissions of the production process as determined in line with section 6.2.2.2 for the reporting period;

$M_i$  is the mass of precursor  $i$  consumed in the production process during the reporting period;

$SEE_{i,dir}$  are the specific direct embedded emissions of precursor  $i$ ;

$SEE_{i,indir}$  are the specific indirect embedded emissions of precursor  $i$ ;

If the precursor was produced within the same installation, you, as the operator, should determine  $SEE$  values using the rules of the Implementing Regulation yourself. In case you receive the precursors from other installations, you should have to request the relevant information from the operator of the installation where the precursor was produced. This

is ideally done using the same template provided by the European Commission for communication between operators and importers (see section 6.11)<sup>64</sup>.

If a precursor material is received from different operators, it may have different *SEE* values for each operator. In this case,  $M_i$  and  $SEE_i$  values need to be used in the calculation separately as if it were different precursor materials.

### Specific embedded emissions (normalising to 1 tonne of product)

Having performed all the above calculations, the embedded emissions at process level only need to be divided by the ‘activity level’ of the process in order to arrive at the specific embedded emissions of the produced goods:

$$SEE_{g,dir} = \frac{EE_{Proc,dir}}{AL_g}$$

$$SEE_{g,indir} = \frac{EE_{Proc,Indir}}{AL_g}$$

Where

$SEE_{g,dir}$  are the specific direct embedded emissions of the goods under the aggregated goods category  $g$ ;

$SEE_{g,indir}$  are the specific indirect embedded emissions of the goods under the aggregated goods category  $g$ ;

$AL_g$  is the activity level of the production process producing goods of the aggregated goods category  $g$ , i.e. the mass of all goods of that category produced during the reporting period.

**Note** that these formulae seem to deviate from the formulae given in the CBAM Regulation Annex IV and in Annex III to the Implementing Regulation. However, they are mathematically equivalent. The difference is only that in this guidance we assume it to be easier to first determine the process-level data before dividing by the activity level. This method is also applied in the Commission’s communication template. However, the legislation gives formulae which do the addition of precursor’s embedded emissions in one single step with the normalisation to one tonne. For complex goods this reads as follows:

$$SEE_g = \frac{AttrEm_g + EE_{InpMat}}{AL_g}$$

$$EE_{InpMat} = \sum_{i=1}^n M_i \cdot SEE_i$$

In case of simple goods,  $EE_{inpMat}$  is simply equal to zero.

The Implementing Regulation gives furthermore formulae for a general approach of first normalising the attributed emissions before calculating SEE as follows:

---

<sup>64</sup> Note that you will not only need the information on the specific embedded emissions of the precursor, but also – if applicable – information on a carbon price due (see section 6.10).

The specific mass consumption  $m_i$  for each precursor  $i$ :  $m_i = M_i/AL_g$

Thereby the specific embedded emissions of complex goods  $g$  may be expressed as:

$$SEE_g = ae_g + \sum_{i=1}^n (m_i \cdot SEE_i)$$

Where:  $ae_g$  are the specific attributed direct or indirect emissions of the production process yielding goods  $g$ , expressed in t CO<sub>2</sub>e per tonne of  $g$ , being equivalent to specific embedded emissions without precursors' embedded emissions:

$$ae_g = AttrEm_g/AL_g$$

In principle it is left to you, as the operator, to decide on the calculation path you choose, if you can demonstrate that the calculation gives the same results as above for  $SEE$ . However, **if you use the Commission's template for communicating your products' embedded emissions to importers (or to other operators who use your goods as precursor), you can assume that the calculation is performed correctly.**



For  $SEE_i$  you, as the operator of the installation, should use the value of emissions resulting from the installation where the input material was produced, provided that that installation's data can be adequately measured and its operator communicates all the required data. During the transitional period, default values for the embedded emissions, as provided by the European Commission, may be used where the precursor is a CBAM good. More information is given in section 6.9.



### 6.3 Defining production process system boundaries and production routes

This section outlines the monitoring approaches available to you, as an operator, for the CBAM transitional period. The textbox below signposts the key sections in the Implementing Regulation for monitoring, relevant for the CBAM transitional period.

---

*Implementing Regulation references:*

**Annex II, Section 3 Production routes, system boundaries, and relevant precursors**

**Annex III, Section A Definitions and principles, in particular, sub-sections A.4. Division of installations into production processes**

---

In order to determine the embedded emissions of the aggregated goods categories covered by Section 2 of Annex II to the Implementing Regulation, you (as an operator) need to define the system boundary for the production of the good. This involves identifying:

- All of the relevant production processes or equipment used during production of the CBAM good;



- All of the fuel, energy (electricity, heat or waste gases<sup>65</sup>) and material flows into and out of these production processes; and
- The sources of GHGs emitted directly from these production processes and, if relevant, during the production of the energy and precursor materials consumed.

*Step 1: List all goods, physical units, inputs, outputs and emissions for the installation*

Firstly, for your installation, list all production process physical units, inputs (e.g. raw materials, fuel, heat, and electricity input required for making the products) and outputs (produced goods, by-products and waste, heat, electricity, waste gases and emissions).

In order to satisfy the CBAM Regulation’s definition of “direct emissions”, heat imported must be taken into account (i.e. added to the installation’s total emissions). “Indirect emissions” from electricity imports must also be taken into account.

*Step 2: Identify relevant production processes and production routes*

In this step you need to list all the goods with their CN codes which your installation produces. Using Table 1 of Section 2 of Annex II to the Implementing Regulation (or using section 5 of this guidance document), you can identify which goods are covered by the CBAM and by which one of the aggregated goods categories. Each aggregated goods category you have identified as relevant will require one production process to be defined for the purpose of the next step. However, some simplifications (see below) are allowed.

Then, identify the industrial processes (the ‘production route’) producing the CBAM goods and the relevant process units, inputs, outputs and emissions.

Using a schematic diagram of your installation can be a helpful way to visually identify the system boundaries. It is also important to identify units such as boilers, CHP plants and steam grids which may be used jointly by different production processes. The emissions of such units must be monitored separately, and attributed to the production processes according to the amount of heat consumed in the different production processes.

In defining the system boundaries of production processes, a number of different installation and production process configurations are possible:

- If an installation makes a single category of good, the installation boundary and production process system boundary for monitoring and reporting embedded emissions are the same.
- If an installation makes several different unrelated categories of good, separate production process system boundaries must be defined within the single installation.
- If an installation makes the same category of good by different production routes, you, as an operator, may define either a single production process system boundary, or separate production process system boundaries of the different production routes. If you assign separate processes, the embedded emissions of the goods are calculated separately for each production route.

---

<sup>65</sup> For definition of ‘waste gases’ please see section 6.7.5.

- If an installation makes a category of complex good and its precursor and where this precursor is wholly used to make the complex good, a joint (single) production process system boundary may be defined within the installation (**‘bubble approach’**<sup>66</sup>).
- If an installation also produces non-CBAM goods alongside CBAM goods, only production process system boundaries needs to be defined for the processes relating to CBAM goods within the installation. However, a recommended improvement from the basic requirements would be to also define an additional production process system boundary for the non-CBAM good, in order to confirm all relevant emissions have been covered.

In addition to the above, a number of **simplifications** apply for certain sectors in the transitional period, namely for:

- **Iron and steel installations** producing two or more goods from specific product groups<sup>67</sup> may monitor and report embedded emissions defining one joint production process, provided that none of the produced precursor materials are sold separately (i.e. the ‘bubble approach’ may be used);
- **Aluminium installations** producing two or more goods from unwrought aluminium or aluminium product groups may monitor and report embedded emissions defining one joint production process, provided that none of the produced precursor materials are sold separately (i.e. the ‘bubble approach’ may be used); and
- **Mixed fertilizers installations** may simplify the monitoring of the respective production process by determining one uniform value of embedded emissions per tonne of nitrogen contained in the mixed fertilizers, irrespective of the chemical form of nitrogen (ammonium, nitrate or urea forms).

In defining the system boundaries of a production process, **key criteria** are:

- The system boundaries should enclose the physical units<sup>68</sup> performing the sequential process steps to produce the good;
- Any other (100%) dedicated units that support the production process and allows it to reach and maintain its full production capacity should be included in the system boundary – for example CHP units (input activity) or flue gas scrubbing (output activity).
- Physical units used by more than one production process (e.g. boilers supplying steam to several processes) need to be virtually split (by treating their emissions separately in accordance with the formulae provided in section 6.2.2.2);
- Only stationary units are included in the system boundary – emissions from vehicles (forklifts, trucks, bulldozers etc.) are not included in the system boundary of a production process.

---

<sup>66</sup> See section 7.2.2.1 for an example of the bubble approach.

<sup>67</sup> Sintered ore, pig iron, FeMn, FeCr, FeNi, DRI, crude steel, iron or steel products

<sup>68</sup> “Units” means industrial equipment such as kilns, furnaces, boilers, reactors, distillation columns, dryers, flue gas cleaning, etc.

Overall, the relevant emissions of an installation should be 100% covered between CBAM goods and any non-CBAM goods, whereby:

- For an installation with a single production process, all (100%) relevant emissions from the installation should be attributed to the CBAM good production process.
- For an installation with several relevant production processes, you, as an operator, should where necessary attribute shared equipment, ‘source streams’ and emission sources between the different production processes identified.

Therefore, all inputs, outputs and corresponding emissions in your installation should be attributed to a production process, unless they relate to any non-CBAM good.

You should take particular care to ensure that production processes do not overlap, i.e. inputs, outputs and corresponding emissions should not be covered by more than one production process.

You should also note that, for transparency purposes, the rationale for any production processes defined in the CBAM transitional period may need to be provided in the subsequent definitive period, to the verifier and the authority who checks the CBAM declarations.



---

*Recommended improvement:*

*List all emission sources and source streams of the total installation, in order to perform completeness checks, as well as to control the energy and emissions efficiency of the installation as a whole.*

---



Section 7.1.2 provides an example of how to define separate production processes for the different CBAM goods of a notional installation in the cement sector.

*Step 3: Determine monitoring needs on installation level*

Once you have identified all the CBAM-relevant production processes and the related emission sources and source streams (i.e. fuels and materials contributing to emissions), you need to decide on the monitoring approaches. At installation level, ‘calculation-based’ and ‘measurement-based’ approaches are available, or for some of the transitional period other methods from other carbon pricing or MRV systems. More details on the applicable methods are presented in section 6.4.

In some cases, additional material or energy flows need to be monitored which take place between production processes, and which are not necessary for installation-level emission monitoring. For example, a waste gas resulting from the production of pig iron, which is consumed in the production of iron or steel products downstream, would not have to be separately monitored at installation level. For attribution to different production processes and subsequently to goods, such monitoring is necessary and needs to be identified for the next step.

#### Step 4: Assign emissions to production processes

Once the methods for determining total emissions of an installation have been determined, you must ensure to have all data for splitting the emissions according to the production processes defined and the goods produced.

In this step, this is done without considering embedded emissions of precursor materials used. Instead, each good is considered a “simple good”, i.e. only the (direct and/or indirect) emissions from each production process is taken into account. If an installation also produces some precursor materials, they are to be considered separately as individual goods themselves.

At this stage the aim is to attribute 100% of the installation’s emissions to goods, without gaps and double counting. Note that in this context “electricity” and “heat” produced for use outside of the production process are also “goods” (they have an economic value and can be traded). Also, goods which are not covered by the CBAM have to be considered in order to reach this 100% target.

## **6.4 Planning your monitoring**

This section outlines the monitoring approaches available to you, as an operator, over the CBAM transitional period. The textbox below signposts the key sections in the Implementing Regulation for monitoring, relevant for the CBAM transitional period.

---

#### *Implementing Regulation references:*

**Annex III, Section A Definitions and principles, in particular, sub-sections: - A.1. Overall approach; - A.2. Monitoring principles; - A.3. Methods representing the best available data source; - A.4. Division of installations into production process.**

**Annex III, Section B Monitoring of direct emissions, in particular, sub-sections: - B.1. Completeness of source stream and emissions sources; - B.2. Choice of monitoring methodology; - B.4. Requirements for activity data; - B.5. Requirements for calculation factors for CO<sub>2</sub>.**

**Annex III, Section E Monitoring of precursors.**

**Annex III, Section F Rules for attributing emissions of an installation to goods.**

**Annex III, Section H Optional measures to increase quality of data.**

---

### **6.4.1 What documentation is needed to plan your monitoring**

As an operator, you should document the monitoring methodologies used to determine the CBAM emissions and production data for your installation and production processes. This monitoring methodology documentation (MMD) should define the system boundaries of your installation and each of your production processes, in line with the specific requirements for each industry sector. The MMD should also identify which source streams use a calculation-based standard or mass balance method, and for which emission sources a measurement-based approach is used. It should also contain all other relevant

monitoring approaches, such as for the qualities and quantities of CBAM goods produced, heat, electricity and waste gas flows, as applicable.

It is recommended that you, as an operator, also produce a diagram and accompanying process description of your installation, to help:

- Visualise production process system boundaries and source streams;
- Confirm that there is no double counting of, or data gaps in emissions reporting.

A good document management system is advisable from the outset. To help with this the MMD should ideally be collated into a single document, comparable to the ‘Monitoring Plan’ (MP) known in other carbon pricing or MRV systems (and in the EU ETS).

#### **6.4.2 Monitoring methodology principles and procedures**

As an operator, you are required to document a monitoring methodology to ensure that all the monitoring activities are carried out consistently from one year to the next. In this regard, the MMD serves as a “rule book” for all your installation staff, as well as for training of new staff involved in the monitoring. Should you want to use a GHG verifier voluntarily, the MMD will serve as essential background information for the verifier.

#### **Guiding principles for planning your monitoring:**

- **As simple monitoring methodology as possible**, which takes into account existing systems in place at your CBAM installation and is based on using the **most reliable data sources**, robust metering instruments, short data flows, and **effective control procedures**.
- **Full transparency** and traceability of how data is compiled, for the purposes of verification in the definitive period of your CBAM data, **stating any calculations or assumptions** made and what controls are in place to ensure data accuracy.
- Supplementary **written procedures**, providing clear instructions for activities implemented under the MMD, locations of relevant data and setting out roles and responsibilities.

As installations undergo technical changes over the years, the MMD and written procedures should be considered living documents that **should be regularly reviewed** and updated by you, as the operator.

Typical elements of a monitoring methodology involve the following activities for you, as the operator (as applicable, depending on the installation’s specificities):

- Data collection (metering data, invoices, production protocols, stock determination etc.).
- Sampling of materials and fuels.
- Laboratory analyses of fuels and materials.
- Maintenance and calibration of meters.
- Description of the calculations and formulae to be used.

- Documentation of standard values used and their sources.
- Control activities (e.g. four-eyes principle for data collection).
- Data archiving (including security to guard against manipulation).
- Regular identification of improvement possibilities (you should attempt to improve their monitoring systems wherever possible).

---

*Recommended improvement: you should regularly check (at least once per year) whether new and more accurate data sources have become available, for the purpose of improving the monitoring approaches.*

---



### 6.4.3 *Written procedures*

Written procedures that supplement the monitoring methodology should include the following elements:

- Managing responsibilities and competency of personnel – description of roles and assignment of responsibilities to key members of staff.
- Data flow and control procedures.
- Quality assurance measures (checks to be carried out).
- Estimation method(s) for substituting data where data gaps are identified.
- Regular review of the monitoring methodology for its appropriateness.
- A sampling plan and process for revision, if required.
- Procedures for methods of analyses, if applicable.
- Procedure for demonstrating evidence for equivalence to EN ISO/IEC 17025 accreditation of laboratories, if relevant.
- Procedures for use of measurement-based methodologies, including for corroborating calculations and for subtracting biomass emissions, if relevant.
- Procedure for regular review and update of the list of products and precursors produced and/or imported by an installation.

You, as the operator, should make sure that all versions of the monitoring documents and procedures are clearly identifiable, and that the most recent versions are always being used by all staff involved.

### 6.4.4 *Choosing best available data sources*

Section A.3 of Annex III to the Implementing Regulation contains details about the general principle that “**best available data sources**” should be used for any kind of monitoring for the purpose of determining embedded emissions of goods falling under the CBAM. In this context:

- “**Best**” means primarily the **most accurate**<sup>69</sup> option to determine the required data. This implies e.g. that when you decide which of two measurement instruments for the same variable should be used, you should choose the one where the operator specifies the lowest “error in use” for the environment in which you use it. Furthermore, where there are instruments under “legal metrological control” (i.e. instruments officially verified under some legislation, e.g. for ensuring accepted measurements for trading of fuels), these should be preferred due to their defined characteristics.

However, “best” includes also the element of data processing. Where personnel have to read a value every hour or every day, then write them down in a journal, which is then manually transferred into an electronic spreadsheet, and where that spreadsheet is not well protected against (unwanted) editing, there are significant risks in the ‘data flow’ which requires specific ‘control procedures’ (see section 6.4.6). A better data source would be one that delivers automatically data from e.g. a process control system to a data base which can be used for extracting data without danger of manipulation. Therefore, “best” involves those data sources with **lowest risk of errors on the data flow**.

- “**Available**” means in the first place that you as an operator have the data source already available, e.g. because the parameters measured are important for your process control or cost calculation etc. If this is not the case, a choice has to be made: Will you purchase an additional measurement system, will you establish a system for sampling materials and performing laboratory analyses, for the purpose of the CBAM? Or do you have the possibility to use other methods, including “indirect” ones (see below), or are there literature sources that provide reasonable and credible standard values for the parameter you require for monitoring (e.g. a standard value for the emission factor of a fuel)?

The legislation provides significant flexibility for answering the above questions. Although “best” sources should be used, the legislation acknowledges that **administrative burden and costs should be limited**. To this end, the concepts of “**technical feasibility**” and “**unreasonable costs**” (see section 6.4.5) are introduced. These allow you to go for “2<sup>nd</sup> best” (or even 3<sup>rd</sup> best”) data sources, if the best one would not be feasible or involve unreasonable costs.

Furthermore, the legislation allows you to use **measurements “not under the operator’s control”**, if necessary. This means that e.g. if your fuel supplier already determines the net calorific value and emission factor of your fuel, or if the supplier owns the flow meter or weigh bridge used for determining the sold fuel quantity, these data may be used for the purpose of the CBAM, and you do not have to purchase your own equipment or analyses. Nevertheless it is to be noted, that the use of monitoring under the operator’s own control is preferred, where possible.

- “**Data sources**” means everything needed for determining all the parameters occurring in the monitoring at emissions level, at production process level and for determining embedded emissions of goods. On an abstract level, this involves in particular the determination of **quantities** of fuels, materials, energy flows etc. and of **quality** of these flows (carbon content of materials, temperature, pressure and saturation of steam, etc.). While more concrete details are given in the

---

<sup>69</sup> More precisely, the aim is to have **lowest uncertainty** of measurements, which includes both concepts, high *accuracy* (the closeness of the measured value to the “true value”) and high *precision* (low variability of measurements).

following sections, which deal with the different parameters, on this abstract level, the following methods are distinguished by the legislation:

- **Direct determination:** This means e.g. the direct reading of a flow meter for natural gas, the weighing of a truck delivering coal, etc., and regarding quality it means applying directly a standard value for an emission factor, or performing laboratory analyses to determine the carbon content of a material directly. Where more than one parameter is required<sup>70</sup>, it is considered ‘direct determination’ if all the parameters are actually measured.
- **Indirect determination:** This is also referred to often as ‘estimation method’. Here you, as the operator, have to make several assumptions, and look for measurements which are somehow connected by a scientifically sound reasoning. For example, if you have a boiler for producing steam but you do not have heat meters, you may use the boiler producer’s specified efficiency in order to calculate the heat amounts based on the fuel consumed. Method B for cement clinker process emissions is in principle also an indirect method: From the amount of CaO and MgO contained in the clinker, one calculates back to the amount of carbonates that are assumed to have been present in the raw meal (the scientific context here is stoichiometry and the likelihood that no other carbonates were present).

It is to be noted that direct determination methods are preferred, but for limiting administrative costs, indirect methods are acceptable.

- **Correlations:** These are an “improved indirect method”, applicable in particular for qualitative parameters of fuels. Most prominently, coal emission factors can often be determined based on correlations between the ash, the calorific value, and the emission factor to be determined. Some process gases can be characterised by using density or thermal conductivity correlating with the gas’ composition (carbon content).

Such correlations need to be regularly (annually) confirmed by laboratory analyses, and are therefore considered “better” than using standard emission factors (which are fixed values), but not as “best” as actual laboratory analyses with representative sampling.

Where you, as the operator of an installation, find that you have more than one data source for the same parameter available, you should choose the “best” one for monitoring, and put it into the monitoring methodology documentation as the “primary data source”. However, you should not discard all other data sources, but define them as a “corroborating data source”, and use the values from that source for checking regularly the consistency of the data with the “primary” data source. It thereby serves your ‘control system’ (see section 6.4.6).

Overall, there is no absolute “right” or “wrong” in selecting data sources. However, it is to be expected that over time you as operator will collect experience with your data sources and find confirmation whether the chosen sources are “best” indeed. Furthermore, new technologies may become available or less costly, and your installation may undergo

---

<sup>70</sup> In particular for determining net heat flows, where the flow of steam, the temperature, pressure and saturation, and the amount and temperature of returned condensate are required.



changes. Therefore, the legislation foresees that regular (annual) review of the monitoring methodology should be performed.

#### **6.4.5 Limiting monitoring-related costs**

As indicated in section 6.4.4, the Implementing Regulation allows the operator to limit the costs caused by monitoring for the purpose of the CBAM, firstly by using existing methods and equipment, to the extent feasible, and secondly by allowing deviation from the preferred approaches, if a monitoring approach is either “technically not feasible”, or if it incurs “unreasonable costs”. These criteria are discussed in more detail in this section.

#### **Determining whether costs are reasonable or not**

Point 8 of section A.3 of Annex III to the implementing Regulation explains that for identifying costs as “unreasonable”, the costs of a monitoring approach or improvement measure must exceed its benefit.

As an operator, you should therefore carry out a cost/benefit analysis, for the specific determination methodology for the data set concerned, to determine whether costs are unreasonable or not. If you then decide that the costs are unreasonable, this calculation should be included in the monitoring methodology documentation as a justification for not choosing a certain approach.

The calculation methodology to use is provided in the Implementing Regulation. The **benefit calculation** includes the following: **Improvement × CO<sub>2</sub>e reference price**.

- The improvement is calculated by multiplying the expected percentage improvement in uncertainty in a measurement, or 1% where no improvement can be quantified, by the related emissions<sup>71</sup>).
- The reference price is EUR 20 per tonne<sup>72</sup> of CO<sub>2</sub>e.

**Cost calculation:** In considering what costs to include in this calculation, you should only include those costs that are additional to their **existing reference system**, i.e. the incremental cost compared to either existing equipment, or for a more expensive (but more accurate) item minus the cost of the equipment that would have been purchased without the CBAM. In this context, the types of costs that should be considered are:

- Investment costs – for new equipment, if applicable. The cost for the new equipment should be the cost per annum depreciated over its economic lifetime e.g. depreciated on a straight-line basis.
- Operating and maintenance costs – such as for annual calibration services.

---

<sup>71</sup> Related emissions are the direct emissions over the reporting period caused by the source stream or emission source concerned, which may be: the emissions attributed to a quantity of measurable heat; the indirect emissions related to the quantity of electricity concerned; or the embedded emissions of a material produced or of a precursor consumed.

<sup>72</sup> This CO<sub>2</sub> price is significantly lower than the actual CO<sub>2</sub> price in the EU ETS, which helps limiting monitoring costs, as more measures are considered “unreasonable” than by using the actual CO<sub>2</sub> price.

- Costs due to disrupted operations – due to plant shutdowns to install new equipment (to mitigate this you, as the operator, may consider timing this to happen at the same time as the annual plant shut down for maintenance); and/or
- Any other reasonable resulting costs.

When you have calculated the above, and the costs exceed the benefit, you are free to choose a less costly monitoring approach or equipment, because costs are considered ‘unreasonable’.

Please note that minor costs are never considered unreasonable. To this end, a threshold is defined of **EUR 2 000 per year**. Below this amount, costs are always considered to be **reasonable additional costs** for taking measures to improve an installation's monitoring approach, in line with the monitoring obligations of the CBAM.

### **Technically feasible**

The second concept for avoiding more costly monitoring approaches is based on ‘technical feasibility’. A measure is considered “not technically feasible”, where the installation has not the technical resources for meeting the needs of a proposed data source or monitoring method so it can be implemented in the required time for the purposes of the CBAM. This can be e.g. the case if there is no space available to install a technical equipment, if there are safety concerns, or if the technology is not available in the country. Technical infeasibility is usually closely linked with unreasonable costs.

#### **6.4.6** *Control measures and quality management*

It is commonly accepted best practice in carbon pricing and GHG monitoring systems that the operator ensures an effective control system for the data flows relevant for the emissions monitoring. Although the Implementing Regulation for the CBAM in Annex III section H clarifies that such measures are purely optional, implementation of such control system is in the best own interest of the operator. Here we outline only briefly how to set up a control system.

##### Step 1: Perform a (simple) risk assessment:

Map out all the data flows from the first point where data occurs (e.g. the fuel invoices, the reading of an instrument in the installation), how it is written down or entered in an IT system, how it is used in calculations until it ends up in the final embedded emissions data which you communicate to EU importers under the CBAM.

Then you identify points with a high risk for errors (high risk means that either the likelihood of the error is high, or that the impact of the error on emissions is very high, or both factors are at least “medium”).

##### Step 2: Establish effective controls

For the identified “high risk” points (and ideally also at least for the “medium risk” points) you need a control measure. If for example there is a high risk for a measurement instrument to fail, for copy & paste errors when data is transferred from a paper-based production journal to a spreadsheet, or where data on a computer is freely accessible to

your whole staff, measures need to be taken. The same applies if there is a risk for incomplete data (e.g. because fuel suppliers are chronically late in sending invoices, etc.).

Step 3: Regularly evaluate if the control measures are effective.

### **Control measures (non-exhaustive)**

One simple measure with a very good cost/benefit ratio is the application of the “four-eyes” principle, i.e. that all data flows are controlled by a second person which is independent from the main person doing the data compilations<sup>73</sup>.

Furthermore, the implementing Regulation lists the following areas that may require attention:

- Quality assurance of the relevant measurement equipment (calibration and maintenance);
- Quality assurance of information technology systems;
- Segregation of duties in the data flow activities and control activities,
- Management of necessary competence of staff;
- Internal reviews and validation of data (this can be done by comparing time series and by performing checks against different data sources, e.g. whether energy efficiency in a process is explainable over time / after improvement measures);
- Corrections and corrective action, where instruments or procedures fail, or where errors (e.g. double counting of fuel or material qualities) happen;
- Control of out-sourced processes (e.g. where laboratories outside the installation are involved, or where instruments not under the operator’s control are used); and
- Keeping records and documentation including the management of document versions.

## **6.5 Determine installation’s direct emissions**

The CBAM Regulation builds on the principle of applying a **top-down approach** to calculating embedded emissions, starting from the installation level, and splitting those emissions such that they are attributed to different production processes, and thereafter to products, with further embedded emissions added for precursor materials.<sup>74</sup> In this subsection we provide guidance on how these calculations can be carried out.

---

<sup>73</sup> Independence means e.g. if an accountant controls the head of environmental, safety & health department who is the main responsible for data collection. Note that regarding competence, both persons need to be trained in the basic concepts of GHG emissions monitoring for the CBAM.

<sup>74</sup> Embedded emissions could theoretically also be calculated using a bottom-up approach. The starting point would be the product to be imported, which is traced through the value chain until all emissions from all previous production steps are added up. In practice, it is usually simpler to monitor the total emissions of a defined installation, since there is usually one main metering device for each fuel which is used in the whole installation, whereas there are less often sub-meters which allow the split of fuel quantity to individual production processes, so that is the method required by the Implementing Regulation for the CBAM.

The emissions at installation level can be monitored by different approaches, which can also be combined, provided that neither gaps nor double counting occur.

As an operator, you should select a **monitoring methodology** on the basis that it gives the most accurate and reliable results (see section 6.4.4), except where a particular method is required for sector-specific reasons. The monitoring methodologies allowed under the CBAM are:

- **Calculation-based approaches**, which entails determining emissions from source streams on the basis of activity data (such as fuel consumption data) and additional parameters from laboratory analyses or standard values, as necessary. Either the ‘standard methodology’ (which distinguishes combustion and process emissions) or ‘mass-balance methodology’ may be used.
- **Measurement-based approach**, which requires a continuous emissions monitoring system (CEMS) to directly measure emissions from emissions sources.
- **Other non-EU country-specific methods**, where they are part of an existing carbon pricing scheme, or a compulsory emission monitoring scheme, or an emission monitoring scheme at the installation which can include verification by an accredited verifier (this could be e.g. a GHG reduction project), and where they lead to similar outcomes as the approaches provided by the Implementing Regulation, in terms of coverage and accuracy of emissions data (see section 6.5.3). Such systems may also methods like, for example, Predictive Emission Monitoring Systems (PEMS).

You can also use a combination of the above approaches, provided that there is no double-counting or data gaps in the emissions reporting, which allows different parts of your installation to be monitored by either of the allowed approaches.

*Figure 6-4: Overview of installation emissions*

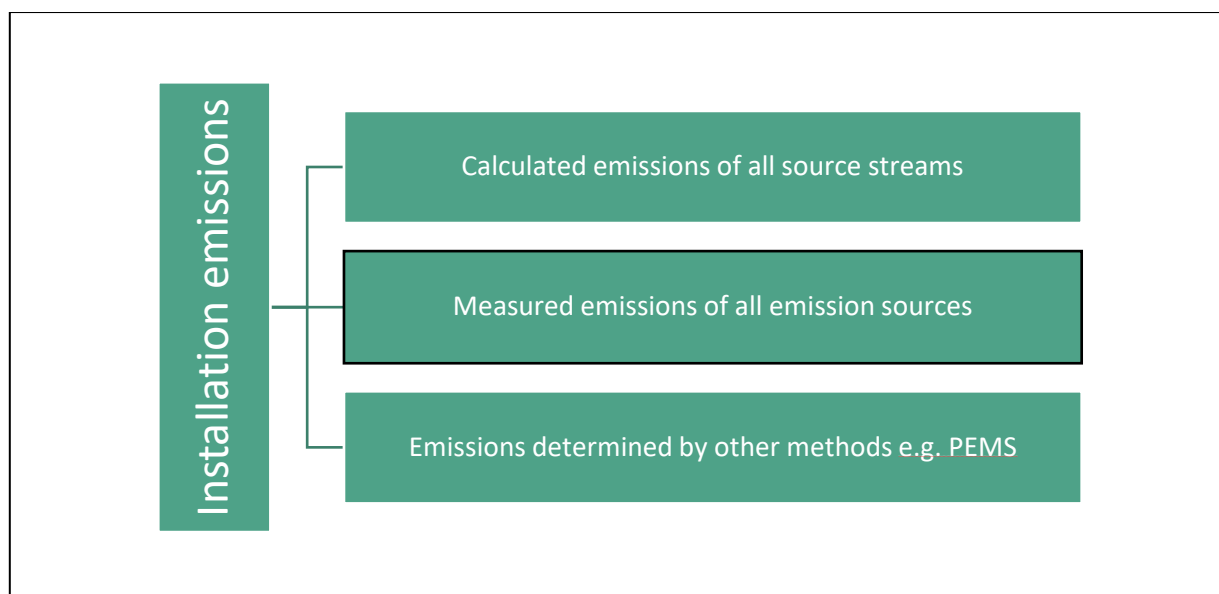

The above *Figure 6-4* illustrates how the installation's emissions are calculated according to the Implementing Regulation Annex III, which is in detail:

$$Em_{Inst} = \sum_{i=1}^n Em_{calc,i} + \sum_{j=1}^m Em_{meas,j} + \sum_{k=1}^l Em_{other,k}$$

Where:

$Em_{Inst}$  are the (direct) emissions of the installation expressed in tonnes CO<sub>2</sub>e;

$Em_{calc,i}$  are the emissions from source stream  $i$  determined using a calculation-based methodology expressed in tonnes CO<sub>2</sub>e;

$Em_{meas,j}$  are the emissions from emission source  $j$  determined using a measurement-based methodology expressed in tonnes CO<sub>2</sub>e, and

$Em_{other,k}$  Emissions determined by another method, index  $k$  expressed in tonnes CO<sub>2</sub>e.

For the definition of the terms 'source stream' and 'emission source' please see section 6.2.2.1. Regarding "other methods" please see section 6.5.3.

During the transitional period, **indirect emissions must also be reported for all sectors**. This section is structured as follows:

- Everything regarding the **calculation-based method** will be summarised in section 6.5.1:
  - The **standard methodology** is discussed in section 6.5.1.1 (with separate sub-sections for combustion and process emissions);
  - The **mass balance** method is presented in section 6.5.1.2;
  - Rules for determining **activity data** are relevant for both, standard and mass balance method. The requirements are given in section 6.5.1.3;
  - Likewise, requirements for the **calculation factors** apply to both methods. The relevant rules (either choosing appropriate **standard values**, using correlations or performing **laboratory analyses** and the related sampling) are given in section 6.5.1.4;
- The **measurement-based method** (using Continuous Emission Measurement Systems, CEMS) is subject of section 6.5.2. It is of particular importance for monitoring of **nitrous oxide (N<sub>2</sub>O)** emissions in the fertilizer sector.
- Section 6.5.3 elaborates on the possibility to use "**non-EU methods**", i.e. monitoring methods other than those given in the CBAM Implementing Regulation.
- Since CO<sub>2</sub> emissions from **biomass** may be considered to be zero under certain conditions, section 6.5.4 gives guidance on the respective rules. These rules apply to all methods, i.e. calculation-based, measurement-based and "non-EU" methods.
- The topic of **PFC (perfluorocarbon)** emissions is shortly touched in section 6.5.5.
- Finally, rules for **transfers of CO<sub>2</sub>** between installations are mentioned in section 6.5.6.

The determination of indirect emissions of an installation is thereafter discussed in section 6.6. From section 6.7 onwards, the rules are described that are necessary for splitting (‘attributing’) the installation’s direct and indirect emissions to production processes. A completely different type of data to be reported is any effective carbon price due. Nevertheless, it should be on the operator’s agenda and documented in the monitoring methodology. It is therefore discussed in section 6.10. Finally, section 6.11 describes the template for communicating the monitored data to EU importers who have to prepare the quarterly CBAM reports.

## 6.5.1 Calculation-based approach

### 6.5.1.1 Standard methodology

The standard approach is straightforward to apply in cases where a fuel or material is directly related to the emissions. It entails the calculation of emissions by means of **activity data** (e.g. amount of fuel or process input material consumed) multiplied by an **emission factor**; two other factors may be applied for correcting the emissions numbers in case of incomplete chemical reactions, based on laboratory analyses, namely the **oxidation factor** for combustion emissions, and the **conversion factor** for process emissions.

Key requirements for using the standard method are:

- **Combustion emissions** – Minimum requirements: Fuel quantity (t or m<sup>3</sup>), Emission factor (t CO<sub>2</sub>/t or t CO<sub>2</sub>/m<sup>3</sup>); **Recommended improvement:** *Fuel quantity (t or m<sup>3</sup>), NCV (TJ/t or TJ/m<sup>3</sup>), Emission factor (t CO<sub>2</sub>/TJ), Oxidation factor, Biomass fraction.*
- **Process emissions** – Minimum requirements: Activity data (t or m<sup>3</sup>), Emission factor (t CO<sub>2</sub>/t or t CO<sub>2</sub>/m<sup>3</sup>); **Recommended improvement:** *Activity data (t or m<sup>3</sup>), Emission factor (t CO<sub>2</sub>/t or t CO<sub>2</sub>/m<sup>3</sup>), conversion factor.*



---

Standard method formulae for combustion and process emissions and parameters are given in the Implementing Regulation Annex III, section B.3.1, and are discussed in further detail below.

---

## Combustion emissions<sup>75</sup>

Combustion emissions are calculated as

$$Em = AD \cdot EF \cdot OF$$

Where:

Em...Emissions [t CO<sub>2</sub>]

AD...Activity data [TJ], calculated as  $AD = FQ \cdot NCV$

EF...Emission factor [t CO<sub>2</sub>/TJ, t CO<sub>2</sub>/t or t CO<sub>2</sub>/Nm<sup>3</sup>]

OF...Oxidation factor (dimensionless), calculated as  $OF = 1 - C_{ash}/C_{total}$

And:

---

<sup>75</sup> ‘Combustion emissions’ are defined by the Implementing Regulation as *greenhouse gas emissions occurring during the exothermic reaction of a fuel with oxygen.*

FQ... Fuel quantity [t or m<sup>3</sup>]

NCV... Net Calorific Value (lower heating value) [TJ/t or TJ/m<sup>3</sup>]

C<sub>ash</sub>... Carbon contained in ash and flue gas cleaning dust (soot)

C<sub>total</sub>... Total carbon contained in the fuel combusted

Factors with units in tonnes are usually to be used for solids and liquids. Nm<sup>3</sup> are usually used for gaseous fuels. In order to achieve numbers of similar magnitude, values are usually given in [1000 Nm<sup>3</sup>] in practice.

The **oxidation factor** for combustion emissions is typically determined by laboratory analyses. The two C variables, above, are expressed as [tonnes C] i.e. the quantity of material or fuel times the concentration of carbon in it. Therefore, not only the carbon content of the ash has to be determined by analysis, but also the amount of ash must be determined for the period for which the oxidation factor is determined.

In order to reduce monitoring effort, you, as an operator, may always use the conservative assumption that **OF = 1**.

Simplified!

For combustion emissions, the emission factor is usually expressed in relation to the energy content (NCV) of the fuel rather than its mass or volume:

- If the emission factor of a fuel is to be calculated from the analyses of carbon content and NCV, the following equation is used:  $EF_i = CC_i \cdot \frac{f}{NCV_i}$
- If the emission factor of a material or fuel expressed as t CO<sub>2</sub>/t is to be calculated from an analysed carbon content, the following equation is used:  $EF_i = CC_i \cdot f$   
Where  $f$  is the ratio of molar mass of CO<sub>2</sub> to C:  $f = 3,664 \text{ t CO}_2/\text{t C}$

It is acceptable to modify the above approach, where you have evidence that higher accuracy can be achieved, as follows:

- Activity data is expressed as fuel quantity (i.e. in t or m<sup>3</sup>), rather than using the above equation;
- EF is expressed as t CO<sub>2</sub>/t fuel or t CO<sub>2</sub>/m<sup>3</sup> fuel, as applicable; and
- NCV can be omitted from the calculation if an EF expressed as t CO<sub>2</sub>/t fuel is used. However, a recommended improvement is to report NCV for allowing consistency checking and your own monitoring of the energy efficiency of **the whole production process**.



Where **biomass** is used as a fuel for combustion and it complies with the sustainability and GHG emissions saving criteria established by the ‘Renewable Energy Directive’ (RED II)<sup>76</sup>, it may be zero-rated for emissions. This applies for accounting purposes only, while physically, still CO<sub>2</sub> is emitted from the installation. Details on these “RED II criteria” are given in section 6.5.4.

<sup>76</sup> Directive (EU) 2018/2001 (2018) on the promotion of the use of energy from renewable sources (recast). See: <http://data.europa.eu/eli/dir/2018/2001/2022-06-07>

Where mixed fuels (i.e. fuels which contain both fossil and biomass components) are used, the emission factor must be determined from the preliminary emission factor and the biomass fraction of the fuel according to the following equation:

$$EF = EF_{pre} \cdot (1 - BF)$$

Where:

EF...Emission factor

EF<sub>pre</sub>... preliminary emission factor (i.e. emission factor assuming the total fuel is fossil)

BF... Biomass Fraction (dimension-less)

For fossil fuels and where the biomass fraction is unknown, BF is set to the conservative value zero.

### Process emissions<sup>77</sup>

Process emissions are calculated as

$$Em = AD \cdot EF \cdot CF$$

Where:

Em...Emissions [t CO<sub>2</sub>]

AD...Activity data [t of material]

EF...Emission factor [t CO<sub>2</sub> / t]

CF...Conversion factor (dimension-less)

You may use the conservative assumption that the **CF = 1** in order to reduce monitoring effort.

Simplified!

Activity data in the above equation may refer to either: an input material; or, to the resulting output from the process. For this purpose, two methods for calculating process emissions are possible Method A (input based) and Method B (output based).

Both methods are considered equivalent. However, Method B (output based) **may only be used where CO<sub>2</sub> process emissions are from carbonates**. For CO<sub>2</sub> process emissions other than from carbonates, only method A should be used. An important case of carbonate process emissions occur during **flue gas desulphurisation** which need to be included in

<sup>77</sup> 'Process emissions' are defined by the Implementing Regulation as *greenhouse gas emissions other than combustion emissions occurring as a result of intentional and unintentional reactions between substances or their transformation, for a primary purpose other than the generation of heat, including from the following processes:*

- (a) the chemical, electrolytic or pyrometallurgical reduction of metal compounds in ores, concentrates and secondary materials;
- (b) the removal of impurities from metals and metal compounds;
- (c) the decomposition of carbonates, including those used for flue gas cleaning;
- (d) chemical syntheses of products and intermediate products where the carbon bearing material participates in the reaction;
- (e) the use of carbon containing additives or raw materials;
- (f) the chemical or electrolytic reduction of metalloid oxides or non-metal oxides such as silicon oxides and phosphates.



the calculation of the emissions related to heat, electricity and CHP units (see sections 6.7.2 to 6.7.4)<sup>78</sup>.

### Carbonate materials process emissions

For calculating process emissions from the thermal decomposition of carbonate-based (inorganic) materials, either of two methods is possible:

- **Method A (input based):** The emission factor, conversion factor and activity data are related to the amount of material input (carbonates) into the process, for which the standard emission factors for carbonates in the Implementing Regulation, Annex VIII, Section 2, Table 3 should be used (taking into account the composition of the material).
- **Method B (output based):** The emission factor, conversion factor and activity data are related to the amount of material output (metal oxides) from the process, for which standard emission factors for metal oxides in the Implementing Regulation, Annex VIII, Section 2, Table 4 should be used (taking into account the composition of the material).

The standard factors mentioned can also be found in **Annex E** of this guidance document.

In choosing which method to use, the method giving the more accurate results **for each source stream** should be used, taking into account the available measurement systems for activity data, and that avoids unreasonable costs.

### Mixed materials process emissions

In case of mixed process input materials, which contain inorganic as well as organic forms of carbon, you may choose to:

- Determine a total preliminary emission factor for the mixed material by analysing the total carbon content, and using a conversion factor and – if applicable – biomass fraction and net calorific value related to that total carbon content; or
- Determine the organic and inorganic contents separately and treat them as two separate source streams.

In both cases, Method A is to be applied. For the biomass fraction of mixed materials, the emission factor for biomass may be set to zero, provided the main purpose of the material's use is different from energy production (i.e. it needs to be clarified that it is really compliant with the definition of 'process emissions'<sup>77</sup>). If the main purpose is heat generation, the "RED II" criteria have to be met for allowing zero-rating of the emissions, as discussed under section 6.5.4 on 'Rules for biomass'.

#### 6.5.1.2 Mass balance method

Like the standard approach, the mass balance approach is a calculation-based method for determining the emissions of an installation. It is used with complex installations, for example at an integrated steelworks, where it may be difficult to link the emissions directly to individual input materials, because the products (and wastes) contain significant amounts of carbon.

---

<sup>78</sup> A second type of process emissions for flue gas cleaning occurs where urea is used for removing NO<sub>x</sub>.

Using a mass balance approach, a complete balance of carbon entering and leaving the installation or a defined part thereof is used. The CO<sub>2</sub> quantities relevant for each source stream are calculated based on the carbon content in each material, without distinguishing fuels and process materials. Non-emitted carbon leaving the installation in products is taken into account by output source streams, which have therefore negative activity data.

---

Mass balance method formulae and parameters are set out in the Implementing Regulation Annex III, section B.3.2.

---

- Key requirements for using the mass balance approach method are: Minimum requirement: Material quantity (t), Carbon content (t C /t material); **Recommended improvement:** Material quantity (t), Carbon content (t C /t material), NCV (TJ/t), biomass fraction.



The following remarks should be considered when setting up a monitoring approach using a mass balance:

- Emissions of carbon monoxide (CO) to the atmosphere are not counted as outgoing source stream in the mass balance, but are considered as the molar equivalent amount of CO<sub>2</sub> emissions. This is easily accomplished by just not listing the CO as outgoing material.
- It is important to comply with the principle of completeness of the monitoring data, i.e. all input materials and fuels must be taken into account, if not monitored by an approach outside the mass balance.

The mass balance is implemented by calculating emissions corresponding to each source stream as follows:  $Em_k = f \cdot AD_k \cdot CC_k$

Where:

$AD_k$  ... activity data [t] of material  $k$ ; for outputs,  $AD_k$  is negative;

$f$  is the ratio of the molar masses of CO<sub>2</sub> and C:  $f = 3.664$  t CO<sub>2</sub>/t C, and

$CC_k$  is the carbon content of material  $k$  (dimensionless and positive).

If the carbon content of a fuel  $k$  is calculated from an emission factor expressed in t CO<sub>2</sub>/TJ, the following equation shall be used:  $CC_k = EF_k \cdot NCV_k / f$

If the carbon content of a material or fuel  $k$  is calculated from an emission factor expressed in t CO<sub>2</sub>/t, the following equation shall be used:  $CC_k = EF_k / f$

### Treatment of biomass in mass balances

Emissions from biomass may be zero-rated if the biomass complies with the “RED II criteria” (see 6.5.4). Since those criteria apply only to energetic use of biomass, it must be established for such source streams if they are used primarily for energy purposes. For example, charcoal used as reducing agent in a blast furnace will qualify as primary non-energetic use.

For mixed fuels or materials containing biomass being included as inputs in a mass balance, the preliminary carbon content is to be adjusted for the fossil fraction only. Where the biomass fraction is not known, it should be taken as if there was no biomass used:

$$CC_k = CC_{pre,k} \cdot (1 - BF_k)$$

Where:

$CC_{pre,k}$  is the preliminary carbon content of fuel  $k$  (i.e. emission factor assuming the total fuel is fossil) and

$BF_k$  is the Biomass Fraction of fuel  $k$  (dimensionless).

Where biomass is used as input material or fuel, and output materials contain carbon, the overall mass balance shall treat the biomass fraction conservatively, meaning that the fraction of biomass in total output carbon shall not exceed the total fraction of biomass contained in input materials and fuels, except if the operator provides evidence of a higher biomass fraction in the output materials by a “trace the atom” (stoichiometric) method or by  $^{14}\text{C}$  analyses.

### 6.5.1.3 Rules for activity data

Section B.4 of Annex III to the Implementing Regulation provides the requirements for determining activity data. Two generic approaches are applicable:

- **Continual metering** at the process where the material is consumed or produced;
- **Batch-wise** determination: Quantities separately (batch-wise) delivered or produced are added up over the reporting year taking into account relevant stock changes. For this purpose, the following formulae shall apply:

$$\circ \text{ Cons} = I - E + S_{start} - S_{end}$$

$$\circ \text{ Prod} = E - I - S_{start} + S_{end}$$

Where *Cons* is the amount of fuel or material consumed during the reporting period, *I* is the amount of the fuel or material ‘imported’<sup>79</sup> to the installation during the reporting period, *E* is the amount of the fuel or material ‘exported’<sup>80</sup> from the installation during the reporting period,  $S_{start}$  is the stock at the start of the reporting period and  $S_{end}$  is the stock at the end of the reporting period.

Where you as an operator find that it would incur unreasonable costs (see section 6.4.5) to determine quantities in stock by direct measurement, those quantities may be estimated either based on data from previous years and correlated with appropriate activity levels for the reporting period, or based on documented procedures and respective data in audited financial statements for the reporting period. Furthermore, if using the exact date at the end of the reporting period leads to unreasonable costs, the next most appropriate day may be chosen to separate a reporting period from the following one. The deviations involved for each product, material or fuel are to be clearly recorded to form the basis of a value representative for the reporting period and to be considered consistently in relation to the next year.

<sup>79</sup> ‘Import’ to the installation includes purchases as well as amounts received without commercial transaction, e.g. materials received from the operator’s own mining sites.

<sup>80</sup> ‘Export’ from the installation includes sales as well as amounts transferred out of the installation for other purposes, e.g. materials sent to an external waste treatment or scrap recycling plant.

According to the Implementing Regulation, it is preferred that you use measurements which are under your, the operator's control. However, if your installation does not have the relevant measurement instruments available, it is acceptable for limiting the monitoring costs to use other measurements, in particular instruments belonging to the supplier of fuels or materials, where a commercial transaction is involved, which requires a quality of instruments that enables mutual trust (these are often instruments under 'legal metrological control'). Using such instruments outside the operator's control is furthermore recommended in case they lead to more accurate results than the operator's own instruments, or if there are other reasons that lead to a lower risk of errors in the data flow (see section 6.4.6 on control measures).

If you as operator make use of a measurement systems outside your own control, you may either use direct readings from that measurement system, if possible, or amounts taken from invoices issued by the trade partner.

### **Requirements for measurement systems**

The key concept for judging the quality of a measuring instrument is the 'uncertainty' associated with the values read from the instrument. As an operator, you need a thorough understanding of that concept for making a choice on the "best" data source. See for this purpose also section 6.4.4 (Choosing best available data sources). The Implementing Regulation gives a range for orientation: For the biggest emissions (source streams leading to emissions of more than 500 000 t CO<sub>2</sub> per year), the uncertainty over the full reporting should be 1,5 % or better, while for the smallest sources, uncertainty lower than 7,5 % is considered acceptable. These values are understood to apply if they do not lead to unreasonable costs.

Where you have to replace a measuring instrument, e.g. because of malfunction or because calibration shows that the desired uncertainty is not met anymore, you should replace it by an instrument that ensures meeting the same or a better uncertainty level compared to the existing instrument. (i.e. you should always strive for improvement of the monitoring method, but at least keep the existing standard).

#### *6.5.1.4 Rules for calculation factors*

Calculation factors are all variables used in the calculation-based approaches except the activity data. This section covers rules for the emission factor (EF), net calorific value (NCV), oxidation factor (OF), conversion factor (CF), carbon content (CC) and biomass fraction (BF) for the formulae given in sections 6.5.1.1 (standard method) and 6.5.1.2 (mass balance).

In principle, calculation factors are the *qualitative information* on the source streams, which can be determined by laboratory analyses. However, as these involve significant efforts and require specialised competence, the calculation factors are often set to fixed values in the monitoring methodology. This is justified as – on average over a whole GHG reporting system – they provide sufficiently representative data.

The calculation factors need to be determined consistently with the state used for related activity data. For example, if the activity data relates to coal weighted as taken from pile, which may contain significant moisture from rain or dust prevention, then also NCV and carbon content have to be determined with the same moisture level. If the laboratory

analyses are carried out on dry material, the activity data must be adjusted accordingly for moisture, or vice versa.

The Implementing Regulation allows the following methods for setting calculation factors (with increasing data quality, i.e. the first ones are meant for rather small source streams, while for the largest emissions the best type of analyses is recommended):

1. **Fixed values** (“type I standard values”);
2. Fixed Values (“type II standard values”);
3. **Correlations** for determining proxy data;
4. **Laboratory analyses** carried out outside the operator’s control, e.g. by the supplier of the fuel or material, contained in purchase documents, without further information on the methods applied;
5. Laboratory analyses in non-accredited laboratories, or in accredited laboratories, but with simplified sampling methods; and
6. Laboratory analyses in accredited laboratories, applying best practice regarding sampling.

### **Fixed values**

As an operator, you can choose from a relatively large set of options to find the most appropriate value for each of the calculation factors of each source stream you need to monitor. For ensuring consistency over time and for preventing arbitrary changes in the data, you must lay down in the written monitoring methodology documentation (MMD) which values you are using. In some cases (e.g. national GHG inventories of the country where the installation is situated), these values may change over time. In such case you need to document and implement a procedure which allows regular updating this value (in this example, the procedure would e.g. entail that a defined person is responsible for once a year before compiling all emissions data to look up the latest national GHG inventory and determine the required factor from there).

The following are considered ‘Type I standard values’:

- Standard factors provided in Annex VIII to the Implementing Regulation (attached to this guidance document as Annex E);
- Standard factors contained in the latest IPCC guidelines for GHG inventories<sup>81</sup>;
- Values based on laboratory analyses carried out in the past, not older than 5 years and considered representative for the fuel or material.

The following are considered ‘Type II standard values’ (considered more accurate than ‘Type I’ values):

---

<sup>81</sup> United Nations International Panel on Climate Change (IPCC): IPCC Guidelines for National Greenhouse Gas Inventories. Note that also the values in Annex VIII to the Implementing Regulation are taken from this source, but the IPCC guidelines contain more data than that annex.

- Standard factors used by the country where the installation is located for its latest national inventory submission to the Secretariat of the United Nations Framework Convention on Climate Change;
- Values published by national research institutions, public authorities, standardisation bodies, statistical offices etc. for the purpose of more disaggregated emissions reporting than under the previous point<sup>82</sup>;
- Values specified and guaranteed by the supplier of a fuel or material where there is evidence that the carbon content exhibits a 95 % confidence interval of not more than 1 %<sup>83</sup>;
- Stoichiometric values for the carbon content and related literature values for the net calorific value (NCV) of a pure substance;
- Values based on laboratory analyses carried out in the past not older than two years and considered representative for the fuel or material.

### **Correlations for determining proxy data**

You may determine a proxy for the carbon content or emission factor from the following parameters:

- Density measurement of specific oils or gases, including those common to the refinery or steel industry;
- Net calorific value for specific coal types.

The pre-condition for using such correlation is that you can establish an empirical correlation at least once per year using laboratory analyses meeting the requirements given below. The difference to using directly analyses for determining the calculation factors lies in the fact that you need to carry out the analyses only once a year for establishing the correlations, and not for each batch of material. This reduces the overall costs of your monitoring.

### **Requirements for laboratory analyses**

This section applies to all types of laboratory analyses required for determining properties of materials and for determining correlations (see above). Note that this is not limited to source streams and the calculation-based approaches, but may also relate to the goods produced<sup>84</sup> and to all measurements used for measurement-based approaches.

For each batch of material or fuel subject to analyses, a representative sample is required. Analysis results shall only be used in calculation in respect of the batch from which the sample was taken.

---

<sup>82</sup> For example, the national GHG inventory may use only one emission factor for coal in the country, but a research institute may have published different factors representative for different coal mines or mining regions. If you know the source of your coal, these factors will be more appropriate to use.

<sup>83</sup> If this variation level is not complied with, the value would be considered a 'Type I' value.

<sup>84</sup> See sector-specific sections in section 7 which mention additional parameters that need to be reported together with embedded emission.

Any analyses, sampling, calibrations and validations for the determination of calculation factors shall be carried out by applying methods based on corresponding ISO standards. Where such standards are not available, the methods shall be based on suitable (European) EN or national standards or requirements laid down in an ‘eligible MRV system’ (see section 6.5.3). Where no applicable published standards exist, suitable draft standards, industry best practice guidelines or other scientifically proven methodologies may be used, limiting sampling and measurement bias.

### Analysis frequency

The number of analyses per fuel or material per year strongly impacts the overall costs for monitoring. It is therefore desirable not to carry out too many analyses. However, where materials are very heterogeneous, more analyses are required. Below we discuss the required or recommended analyses frequency. This must not be misunderstood as the frequency of taking samples, which is discussed thereafter.

The Implementing Regulation in Section B.5.4.2 contains a table with minimum frequencies of analyses for different material types. These build on experience in the EU ETS for being useful orders of magnitude. If you as an operator want to deviate from this table, you should consider the following:

- If your installation is applying an ‘eligible MRV system’ (see section 6.5.3), you may use the analysis frequency applicable in that system for the same type of material or fuel;
- If the minimum frequency listed in would incur unreasonable cost;
- If the fuel or material is sufficiently homogenous (demonstrated based on data from recent reporting periods), you may apply lower analysis frequencies. This is the case if any variation in the analytical values for the respective fuel or material does not exceed 1/3 of the uncertainty that you apply in determining the activity data of the relevant fuel or material.

If the table does not contain an applicable minimum frequency, the best choice is to use this 1/3 rule, i.e. to chose to analyse as frequently as it leads to this 1/3 uncertainty over the whole reporting period.

*Table 6-1: Minimum analyses frequencies in accordance with the Implementing Regulation*

<b>Fuel/material</b>	<b>Minimum frequency of analyses</b>
Natural gas	At least weekly
Other gases, in particular synthesis gas and process gases such as refinery mixed gas, coke oven gas, blast-furnace gas, convertor gas, oilfield, and gas field gas	At least daily — using appropriate procedures at different parts of the day
Fuel oils (for example light, medium, heavy fuel oil, bitumen)	Every 20 000 tonnes of fuel and at least six times a year
Coal, coking coal, coke, petroleum coke, peat	Every 20 000 tonnes of fuel/material and at least six times a year
Other fuels	Every 10 000 tonnes of fuel and at least four times a year

<b>Fuel/material</b>	<b>Minimum frequency of analyses</b>
Untreated solid waste (pure fossil or mixed biomass/fossil)	Every 5 000 tonnes of waste and at least four times a year
Liquid waste, pre-treated solid waste	Every 10 000 tonnes of waste and at least four times a year
Carbonate minerals (including limestone and dolomite)	Every 50 000 tonnes of material and at least four times a year
Clays and shales	Amounts of material corresponding to emissions of 50 000 tonnes of CO <sub>2</sub> and at least four times a year
Other materials (primary, intermediate, and final product)	Depending on the type of material and the variation, amounts of material corresponding to emissions of 50 000 tonnes of CO <sub>2</sub> and at least four times a year

Note regarding “number of times a year” in Table 6-1 above: Where an installation operates for part of the year only, or where fuels or materials are delivered in batches that are consumed over more than one reporting period, a more appropriate schedule for analyses may be chosen, provided that it results in a comparable uncertainty as under the last point of the previous subparagraph.

#### **Frequency of Sampling” versus “Frequency of Analyses”<sup>85</sup>**

The Implementing Regulation refers to “Frequency of Analyses” in Annex III section B.5.4.2. Depending on the specific situation, the operator may note in the MMD e.g. that the minimum frequency of analyses of the emission factor of a certain source stream is four times a year.

This term “Frequency of Analyses” must not be confused with the “Frequency of Sampling”, i.e. the frequency of taking samples or increments from a batch or delivery of a fuel or material. In general, a lot more samples/increments than four have to be taken over the year to obtain representative results.

**Example:** A coal firing plant is burning 500 000 tonnes of coal a year. In accordance with Table 6-1, the operator is required as a minimum to analyse every 20 000 tonnes of coal. This will at least result in 25 different laboratory samples that are analysed each year. The main objective of the sampling plan, which also includes the frequency of sampling, is to prepare (at least) 25 laboratory samples that are representative for each of the 20 000 tonne batches. In order to have representative laboratory samples more than just one sample/increment will have to be taken from each 20 000 tonne batch.

<sup>85</sup> Text based on Guidance Document No.5 on EU ETS Monitoring and Reporting (“Sampling and Analyses”), [https://climate.ec.europa.eu/system/files/2021-10/policy\\_ets\\_monitoring\\_gd5\\_sampling\\_analysis\\_en.pdf](https://climate.ec.europa.eu/system/files/2021-10/policy_ets_monitoring_gd5_sampling_analysis_en.pdf)



## **Sampling**

Samples shall be representative for the total batch or time period of deliveries for which they are taken. In order to ensure representativeness, the heterogeneity of the material has to be taken into account, as well as all other relevant aspects such as the available sampling equipment, possible segregation of phases or local distribution of particle sizes, stability of samples, etc. The sampling method shall be laid down in the monitoring methodology documentation.

It is recommended to use a dedicated **sampling plan** for each relevant material or fuel, following applicable standards, containing the relevant information on methodologies for the preparation of samples, including information on responsibilities, locations, frequencies and quantities, and methodologies for the storage and transport of samples. More detailed guidance on sampling plans (although from perspective of the EU ETS instead of the CBAM) can be found in the Commission's EU ETS Guidance document No.5 (see footnote 85).

## **Recommendations for laboratories**

Laboratories used to carry out analyses for the determination of calculation factors shall be accredited in accordance with ISO/IEC 17025, for the relevant analytical methods. Laboratories not accredited may be used for the determination of calculation factors only where there is evidence that access to accredited laboratories is technically not feasible or would incur unreasonable costs (see section 6.4.5), and that the non-accredited laboratory is sufficiently competent. A laboratory is considered sufficiently competent if it fulfils all of the following criteria:

- It is economically independent of the operator, or at least organisationally shielded from influence by the management of the installation;
- It applies the applicable standards for the analyses requested;
- It employs personnel competent for the specific tasks assigned;
- It appropriately manages the sampling and sample preparation, including control of sample integrity;
- It regularly carries out quality assurance on calibrations, sampling and analytical methods, by suitable methods, including regular participation in proficiency testing schemes, applying analytical methods to certified reference materials, or inter-comparison with an accredited laboratory; and
- It manages equipment appropriately, including by maintaining and implementing procedures for calibration, adjustment, maintenance and repair of equipment, and record keeping thereof.

## **Determining the biomass fraction**

For the determination of the biomass fraction some additional rules are to be taken into account:

- Biomass fraction needs to be determined only for mixed materials which contain biomass and fossil fractions. For pure fossil fuels, the biomass fraction is zero. For pure biomass, it is one (100%).

- If the biomass fraction is hard to analyse or if as an operator you do not want to make use of zero-rating (e.g. because the biomass fraction is very small anyway), you may apply the conservative approach to assume the whole material to be fossil.
- Only biomass which complies with the “RED II criteria” (see section 6.5.4) may be counted as “biomass fraction”. Any remaining other biomass is counted as part of the fossil fraction.

Additional guidance:

- If you want to determine the biomass fraction by laboratory analyses, the appropriate standard to use is ISO 21644:2021 (Solid recovered fuels – Methods for the determination of biomass content) or EN 15440 (Solid recovered fuels – Methods for the determination of biomass content). These standards offer three methods (selective dissolution method; manual sorting method; <sup>14</sup>C method). All three methods have advantages and disadvantages. Therefore, the method to be used must be carefully selected for the specific purpose of the source stream at hand, taking into account the limitations of each method as described in the standard.
- As industrial installations often use wastes from defined production processes from their own or from neighbouring installations, the composition of the wastes is often well-known. It is therefore an acceptable approach to determine the biomass fraction based on a kind of mass balance of the process producing the waste, where possible. For example, if wastes from a wood particle board producer are combusted, it may be possible to determine the biomass fraction (wood) and fossil fraction (resins) from the “recipe” of the boards.

### **6.5.2 Measurement-based Methodology – Continuous Emission Measurement Systems (CEMS)**

In contrast to the calculation-based approaches, the greenhouse gases in the installation’s off-gases in the stack may be measured. This is difficult in installations with many emission points (stacks) or indeed impossible where fugitive emissions have to be taken into account. On the other hand, the strength of the measurement-based methodologies is the independence of the number of different fuels and materials used (e.g. where many different waste types are combusted).

The application of CEMS (Continuous Emission Measurement Systems) always requires two elements:

- Measurement of the GHG concentration; and
- Measurement of the volumetric flow of the gas stream where the measurement takes place.

The CBAM Implementing Regulation requires the mandatory use of the measurement-based approach for the monitoring of N<sub>2</sub>O emissions, where this is defined as a relevant greenhouse gas emission for the CBAM good (i.e. for nitric acid and fertilizer production).

The Implementing Regulation gives detailed requirements in Section B.6 of Annex III. The essential requirements are summarised here.

## Calculating the emissions of a reporting period (annual emissions)

$$GHG\ EM_{total}[t] = \sum_{i=1}^{HoursOp} (GHG\ conc_{hourly,i} \cdot V_{hourly,i}) \cdot 10^{-6}[t/g]$$

Where:

$GHG\ Em_{total}$  are the total annual GHG emissions in tonnes;  $GHG\ conc_{hourly,i}$  are the hourly concentrations of GHG emissions in  $g/Nm^3$  in the flue gas flow measured during operation for hour or shorter reference period  $i$ ;  $V_{hourly,i}$  is the flue gas volume in  $Nm^3$  for one hour  $i$ , determined by integrating the flow rate over the hour, and  $HoursOp$  = are the total number of hours for which the measurement-based methodology is applied, including the hours for which data has been substituted in accordance with Section B.6.2.6 of this Annex. The index  $i$  refers to the individual operating hour.

Hourly values shall be averages over all individual measurements during that hour. Note that instead of full hours other reference periods (e.g. half-hours) may be used, if this fits better to the configuration of the measuring instrument or to requirements for measurements for other purposes carried out at the installation.

## CO<sub>2</sub> emissions from biomass

Where relevant, any CO<sub>2</sub> amount stemming from biomass which complies with the “RED II criteria” (see section 6.5.4) may be subtracted from the total measured CO<sub>2</sub> emissions. For this purpose, one of the following methods must be used to determine the amount of biomass CO<sub>2</sub> emissions:

1. A calculation-based methodology, determining the biomass fractions of all used source streams separately;
2. Methodologies using analyses and sampling based on ISO 13833 (Stationary source emissions — Determination of the ratio of biomass (biogenic) and fossil-derived carbon dioxide — Radiocarbon sampling and determination);
3. The ‘balance method’ based on ISO 18466 (Stationary source emissions — Determination of the biogenic fraction in CO<sub>2</sub> in stack gas using the balance method);
4. Other methods based on international standards;
5. Other methods allowed by an eligible MRV system (see section 6.5.3).

## Determination of flue gas flow

The measurement of the flue gas flow is difficult, as the measuring point(s) must be selected such that measurement is representative for the whole stack’s cross section (see also “quality requirements” below). Therefore, as an alternative method, flow may be calculated using a suitable mass balance. This would have to take into account, for CO<sub>2</sub> emissions: all significant parameters on the input side, including at least input material loads, input airflow and process efficiency, and on the output side at least the product output and the concentration of oxygen (O<sub>2</sub>), sulphur dioxide (SO<sub>2</sub>) and nitrogen oxides (NO<sub>x</sub>).

## Treatment of measurement gaps

Where the continuous measurement equipment for a parameter is out of control, out of range or out of operation for part of the hour or reference period, the related hourly average shall be calculated pro rata to the remaining data points for that specific hour or shorter reference period, provided that at least 80 % of the maximum number of data points for a parameter are available. Where fewer than 80 % of the maximum number of data points for a parameter are available, the following calculation is used:

$$C_{subst}^* = \bar{C} + 2 \sigma_c$$

Where:  $\bar{C}$  is the arithmetic mean of the concentration of the specific parameter over the whole reporting period or, where specific circumstances applied when data loss occurred, an appropriate period reflecting the specific circumstances and  $\sigma_c$  is the best estimate of the standard deviation of the concentration of the specific parameter over the whole reporting or, where specific circumstances applied when data loss occurred, an appropriate period reflecting the specific circumstances.

Where the reporting period is not applicable for determining such substitution values due to significant technical changes at the installation, another sufficiently representative timeframe shall be chosen for determining the average and standard deviation, where possible with the duration of at least 6 months.

In the case of a parameter other than concentration, substitute values shall be determined through a suitable mass balance model or an energy balance of the process. This model shall be validated by using the remaining measured parameters of the measurement-based methodology and data at regular working conditions, considering a time period of the same duration as the data gap.

## Quality requirements

All measurements shall be carried out applying methods based on international standards, such as:

- ISO 20181:2023 Stationary source emissions — Quality assurance of automated measuring systems;
- ISO 14164:1999 Stationary source emissions — Determination of the volume flowrate of gas streams in ducts — Automated method;
- ISO 14385-1:2014 Stationary source emissions — Greenhouse gases — Part 1: Calibration of automated measuring systems;
- ISO 14385-2:2014 Stationary source emissions — Greenhouse gases — Part 2: Ongoing quality control of automated measuring systems;
- other relevant ISO standards, in particular ISO 16911-2 (Stationary source emissions — Manual and automatic determination of velocity and volume flow rate in ducts).

Where no applicable published standards exist, suitable draft standards, industry best practice guidelines or other scientifically proven methodologies shall be used, limiting sampling and measurement bias.

All relevant aspects of the continuous measurement system shall be considered, including the location of the equipment, calibration, measurement, quality assurance and quality control. For competence requirement of the laboratory, see section 6.5.1.4.

### Further requirements

CO<sub>2</sub> emissions determined by a measurement-based methodology shall be **corroborated by calculating** the annual emissions of each greenhouse gas in question for the same emission sources and source streams. For this purpose, the requirements for calculation-based approaches may be simplified as appropriate.

Where CO<sub>2</sub> is measured, any amounts of carbon monoxide (CO) emitted shall be taken into account as the molar equivalent of CO<sub>2</sub>.

### 6.5.3 Non-EU country specific methods

The Implementing Regulation defines an ‘eligible MRV system’ as follows:

*‘Eligible monitoring, reporting and verification system’ means the monitoring, reporting and verification systems where the installation is established for the purpose of a carbon pricing scheme, or compulsory emission monitoring schemes, or an emission monitoring scheme at the installation which can include verification by an accredited verifier, in accordance with Article 4(2) of this Regulation.*

The mentioned Article 4(2) allows the use of monitoring approaches of an eligible MRV system **until 31 December 2024, if they lead to similar coverage and accuracy of emissions data** compared to the methods listed in Annex III to the Implementing Regulation (i.e. the calculation-based and measurement-based approaches as discussed in sections 6.5.1 and 6.5.2).

In practice, for you as an operator of an installation producing goods to be imported into the EU that fall under the scope of the CBAM, this means:

- You have to develop your monitoring methodology as soon as possible. Importers will require your first data on emissions for their first report by the end of January 2024, covering embedded emissions of goods imported from October to December 2023.
- If your installation is already under an ‘eligible MRV system’, you do not start from scratch, and you can use (at least some) data from that system for a transition period until then end of 2024.

How can you find out if your installation is covered by an eligible MRV system, so you can use its methods during start-up of the CBAM? This is the case if either of the following applies:

- The installation is participating in a ‘carbon pricing scheme’, that can be either an emission trading system (ETS), or a carbon tax, levy or fee. For eligibility it is important that this scheme is mandatory and regulated by a legislation, i.e. GHG emissions monitoring rules exist;

- The installation is participating in a compulsory GHG reporting scheme, i.e. only monitoring and reporting (and perhaps verification) are mandatory, but there is no carbon pricing involved;
- The installation participates in an emission monitoring scheme at the installation (non-mandatory), which can include verification by an accredited verifier; for eligibility, again it can be assumed that a fixed set of monitoring rules provided by an accepted governance body must exist. Certain GHG reduction projects, such as e.g. under the CDM (the UN’s Clean Development Mechanism), may qualify.

In any event, before you start to use those MRV systems’ rules, you have to perform a check whether they lead to similar coverage and accuracy of emissions data.

#### 6.5.4 Treatment of biomass emissions

The textbox below signposts the key sections for biomass in the Implementing Regulation, relevant for the CBAM transitional period.

---

*Implementing Regulation references:*

**Annex III, Section B Monitoring of direct emissions, B.3.3 Criteria for zero-rating of biomass emissions and B.6.2.3 CO<sub>2</sub> emissions from biomass (CEMS).**

**Annex VIII, Standard factors used in the monitoring of direct emissions, Table 2.**

---

Under the rules for GHG inventories established by the IPCC and used under the Paris agreement, CO<sub>2</sub> emissions of biomass are accounted for at the point where the biomass is harvested (e.g. when a forest is felled). To avoid double counting it is therefore logical to **“zero-rate” these emissions**, i.e. to account for the CO<sub>2</sub> emissions as zero, where biomass is consumed as fuel or process material, despite the fact that CO<sub>2</sub> is physically emitted to the atmosphere at that point. EU climate policy has found that this type of accounting may lead to some unintended incentive to use biomass excessively with unfavourable environmental impacts (e.g. on biodiversity and soil quality). Therefore, the EU’s legal instrument for encouraging the use of renewable energy, the “RED II” (re-cast Renewable Energy Directive<sup>86</sup>), introduced a set of **“sustainability and GHG savings criteria”** (which are summarised as **“RED II criteria”** in this guidance document), which have to be met for zero-rating biomass emissions. The monitoring rules under the EU ETS require that those criteria have to be met for zero-rating biomass emissions. Otherwise, the emissions are treated as if they were from fossil sources. **The CBAM Implementing Regulation requires the same criteria to be met** in order to achieve the goal to put a similar CO<sub>2</sub> price on goods produced outside the EU as to those produced in the EU and under the EU ETS.

Since the correct application of the “RED II criteria” is a relatively complex task, which is potentially only relevant for a relatively small number of installations, this section gives



---

<sup>86</sup> Directive (EU) 2018/2001, on the promotion of the use of energy from renewable sources (recast). See: <http://data.europa.eu/eli/dir/2018/2001/2022-06-07>

only a quick overview of the most relevant points. A more detailed explanation of the applicable RED II criteria is given in **Annex D** of this document.

It is recommended that you, as an operator, include a written procedure in your Monitoring methodology documentation to attribute each batch of biomass used in the installation to either a ‘RED II compliant biomass’ source stream or to a ‘non-RED II compliant biomass’ source stream, depending on whether the sustainability and/or greenhouse gas criteria are met, or not.

Note that RED II criteria apply only where **biomass is used as a fuel** (“for energy purposes”). Where **biomass is used as a process input** (e.g. where charcoal is used as reduction agent in a blast furnace or for producing electrodes), such material may always be zero-rated without applying RED II criteria.

### **Demonstrating compliance with RED II criteria**

There are two ways in which operators can demonstrate compliance with the RED II sustainability and GHG savings criteria:

- Using a **certification scheme** that provides ‘proofs of sustainability’ (PoS, i.e. a confirmation of compliance with that scheme’s rules) and that complies with the requirements of the RED and the relevant implementing Regulation<sup>87</sup>.

Such certification schemes can operate world-wide. If you as an operator want to be certain whether the scheme complies with all the relevant Regulations under the RED II, you should select a scheme that has been ‘recognised’ (i.e. approved) by the European Commission under these rules.<sup>88</sup>

- You can also **collect all relevant data and perform relevant calculations yourself**, as operator of the installation using the biomass. Annex D of this guidance document explains the principles for this approach.

#### **6.5.5 Determine PFC (perfluorocarbon) emissions**

Section B.7 of Annex III to the Implementing Regulation describes the determination of PFC (Perfluorocarbon) emissions. PFC emissions are currently only covered by the CBAM for Aluminium goods. The gases to be monitored are CF<sub>4</sub> and C<sub>2</sub>F<sub>6</sub>. Emissions from anode effects as well as fugitive emissions are to be included. The method is based on the guidance “Aluminium sector greenhouse gas protocol” published by the International Aluminium Institute (IAI)<sup>89</sup>. This uses a calculation-based approach which significantly deviates from the calculation-based approach outlined in section 6.5.1. Two different methods are allowed: The “slope method” and the “overvoltage method”. Which method is to be applied depends on the installation’s process control equipment.

While the Implementing Regulation describes the principal requirements and calculation formulae, other details on the applicable methods should be taken from the guidance

---

<sup>87</sup> Commission Implementing Regulation (EU) 2022/996 on rules to verify sustainability and greenhouse gas emissions saving criteria [...], [http://data.europa.eu/eli/reg\\_impl/2022/996/oj](http://data.europa.eu/eli/reg_impl/2022/996/oj)

<sup>88</sup> A list of recognised biomass certification schemes is hosted on the Commission’s website: [https://energy.ec.europa.eu/topics/renewable-energy/bioenergy/voluntary-schemes\\_en](https://energy.ec.europa.eu/topics/renewable-energy/bioenergy/voluntary-schemes_en)

<sup>89</sup> Available from [https://ghgprotocol.org/sites/default/files/2023-03/aluminium\\_1.pdf](https://ghgprotocol.org/sites/default/files/2023-03/aluminium_1.pdf)

mentioned above. Note that on top of the PFC emissions, CO<sub>2</sub> emissions from anode consumption in primary aluminium production are to be included in embedded emissions. Also, all fuel-related emissions from secondary aluminium production as well as from diverse forming steps downstream of aluminium melting need to be covered. For that purpose, the usual calculation-based methods apply.

More details are given in the section on special rules for the Aluminium sector (section 7.4.1.2).

### **6.5.6 Rules for transfers of CO<sub>2</sub> between installations**

Specific rules apply for how emissions are attributed where CO<sub>2</sub> is transferred between installations, where either: i) pure or almost pure CO<sub>2</sub> is being transferred, for example, for use as a chemical feedstock for urea production; or ii) CO<sub>2</sub> that is already an inherent part of a waste gas or other gaseous source stream is transferred.

The text box below gives the references to the relevant annex sections.

---

*Implementing Regulation references:*

**Annex III, Section B.8 Requirements for monitoring of CO<sub>2</sub> transfers between installations**

---

The following sections cover the attribution of direct emissions from CO<sub>2</sub> in these circumstances.

#### *6.5.6.1 Accounting for inherent CO<sub>2</sub> in waste gases and other gaseous source streams*

The term ‘inherent CO<sub>2</sub>’ refers to CO<sub>2</sub> which is contained in a gas, such as natural gas, or in a waste gas source stream, which is then recovered as a fuel or is flared. In order to ensure consistent reporting and avoid double counting, the inherent CO<sub>2</sub> is either accounted for in the CBAM installation in which it originates or in the CBAM installation to which it is transferred, whereby:

- The originating CBAM installation that transfers out a source stream containing inherent CO<sub>2</sub> to another CBAM installation:
  - **Subtracts the CO<sub>2</sub> from its emissions** – usually this is done **using a mass balance**, where the inherent CO<sub>2</sub> is treated in the same way as any other carbon in that outgoing source stream.
  - An **exception** is where the inherent CO<sub>2</sub> is transferred then emitted (vented or flared) or is transferred to a non-CBAM installation or one that does not participate in an eligible MRV system, in which case the inherent CO<sub>2</sub> has to be counted as emissions from the originating CBAM installation.
- Where a receiving CBAM installation transfers in and uses a source stream containing inherent CO<sub>2</sub>:
  - The emission factor (or in case of mass balances, the carbon content) takes into account the inherent CO<sub>2</sub> (i.e. the CO<sub>2</sub> forms a part of the



source stream, and the inherent CO<sub>2</sub> counts as emitted by the installation which emits the CO<sub>2</sub>).

Regarding metering transfers, the same monitoring approach as for the transfer of waste gases is applicable.

Note that the above rules apply to the direct emissions at installation level. For the purpose of calculating attributed emissions of a production process, the formulae given in section 6.2.2.2 apply.

#### 6.5.6.2 *Capture and transfers of CO<sub>2</sub> between installations (CCS and CCU)*

Where pure or almost pure CO<sub>2</sub> emissions are captured at an installation and transferred out to another installation, the CO<sub>2</sub> may be subtracted from the originating installation's emissions (Annex III, B.8.2) provided that both of the following qualifying criteria and conditions are met:

- The originating and receiving installations must both either be CBAM participants or in an 'eligible MRV system' (see section 6.5.3).
- Receiving installations are for the purpose of CO<sub>2</sub> capture:
  - For storage or transport for long-term geological storage; or
  - To use CO<sub>2</sub> to produce products where the CO<sub>2</sub> used is *permanently chemically bound*<sup>90</sup>. Which products are eligible will be defined in an implementing act under the EU ETS Directive (Article 12(3b)) which will also apply for the purpose of the CBAM.

In all other cases, the CO<sub>2</sub> transferred out of the installation is to be accounted for in the emissions of the originating installation.

**Note that criteria of the last bullet point (CO<sub>2</sub> being chemically permanently bound) applies also to situation where the CO<sub>2</sub> is used for this purpose within the same installation. Currently no production process covered by the CBAM has been identified in the relevant legislation to allow considering CO<sub>2</sub> to be considered chemically permanently bound<sup>91</sup>.**

#### 6.5.6.3 *Monitoring requirements*

Regarding the monitoring of inherent CO<sub>2</sub>, the same monitoring approach as for the transfer of waste gases above is applicable. To monitor the quantity of CO<sub>2</sub> transferred from one installation to another, a measurement-based methodology should be used. The receiving and/or the transferring installation should monitor the incoming CO<sub>2</sub> stream using a CEMS, and share and align the quantity transferred to ensure this is reported

---

<sup>90</sup> The Implementing Regulation is aligned here with the applicable EU ETS legislation, which requires as a criterion for counting CO<sub>2</sub> as not emitted that it is used to “*produce products in which the carbon stemming from CO<sub>2</sub> is permanently chemically bound so that it does not enter the atmosphere under normal use, including any normal activity taking place after the end of the life of the product*”. At the time of writing this guidance (summer 2023), EU ETS legislation was under development to define which products or production processes are eligible.

<sup>91</sup> In particular CO<sub>2</sub> bound in the production process of urea is not eligible, as permanence is not given in urea's main use, as a fertilizer.

consistently between both installations. This continuous monitoring can be omitted if the complete CO<sub>2</sub> mass stream of the installation, or of a clearly identifiable part thereof, are transferred. In such case the CO<sub>2</sub> quantity can be calculated from the input source streams of that installation.

For the amount of CO<sub>2</sub> permanently chemically bound in products, a calculation-based methodology should be used, preferably using a mass balance. The chemical reactions applied, and all relevant stoichiometric factors should be set out in the monitoring methodology documentation.

## 6.6 Determine installation's indirect emissions

**For the purpose of the transitional period of the CBAM, indirect embedded emissions have to be reported separately from the direct embedded emissions, for all goods covered.**

Indirect emissions of an installation or of a production process are equivalent to the emissions caused by the production of the electricity consumed in the installation or production process of goods, respectively, multiplied with the applicable emission factor for electricity:

$$AttrEm_{indir} = Em_{el} = E_{el} \cdot EF_{el}$$

Where:

$AttrEm_{indir}$  are the indirect attributed emissions of a production process expressed in t CO<sub>2</sub>;

$Em_{el}$  are the emissions related to electricity produced or consumed, expressed in t CO<sub>2</sub>;

$E_{el}$  is the electricity consumed expressed in MWh or TJ; and

$EF_{el}$  is the emission factor for electricity applied, expressed in t CO<sub>2</sub>/MWh or t CO<sub>2</sub>/TJ.

The general rule for the emission factor is that the operator shall use a default value provided by the European Commission for that purpose. However, Annex IV section 6 defines conditions under which the operator may use actual data for the emission factor:

- If there is a direct technical link between the installation in which the imported good is produced and the electricity generation source; or
- If the operator of that installation has concluded a power purchase agreement with a producer of electricity located in a third country for an amount of electricity that is equivalent to the amount for which the use of a specific [emission factor] value is claimed.

Therefore, if you generate electricity within your own installation, you should use the **emission factor which you determine using the rules discussed in section 6.7.3**. If you receive electricity from a directly technically connected installation (e.g. a CHP unit at

your installation's site<sup>92</sup>) and if that installation uses the same monitoring approaches as outlined in the CBAM Implementing Regulation, you should use the emission factor provided by that installation's operator. Furthermore, if your installation has a power purchase agreement<sup>93</sup> with an installation more remote, again the emission factor provided by that electricity supplier should be used. In all other cases, i.e. for electricity received from the grid, the **default emission factor for electricity in the country or region** as provided by the European Commission shall be used. Those default values are based on data by the IEA and made accessible through the Commission's CBAM Transitional Registry.

## 6.7 Rules required for attributing emissions to production processes

Section 6.2.2 describes the approach to attributing emissions from the installation level to production processes, and section 6.2.2.2 gives the formula for the related calculation. From there it is apparent that for determining attributed emissions of a production process, further parameters beyond the installation's emissions need to be determined. These are the topic of this section, which is structured as follows:

- Some generic rules for attribution parameters to production processes are explained in section 6.7.1. This applies e.g. to splitting source stream data or attributing heat flows, etc.;
- Monitoring rules for flows of heat are discussed in section 6.7.2;
- Electricity monitoring rules are the subject of section 6.7.3;
- Heat and electricity can be produced by 'cogeneration' (CHP), i.e. in a single process. The related joint calculation rules are discussed in section 6.7.4.
- Rules for waste gases are provided in section 6.7.5.

Thereafter, section 6.8 deals with the parameters needed to calculate embedded emissions of goods based on the attributed emissions of the production process, as outlined in section 6.2.2.3, providing guidance on how to determine activity levels of the production process (i.e. the amount of goods produced, section 6.8.1, and data on precursors, section 6.8.2).

### 6.7.1 *Generic rules for metering of parameters to be attributed to production processes*

Section F.3.1 of Annex III to the Implementing Regulation provides generic rules for how to attribute various data sets (source streams, heat, electricity, waste gases) to production processes, as follows:

---

<sup>92</sup> It is a frequently found situation that a central heat and/or electricity supply serves several installations at the same site. Usually there is a close link also in the company structure, or clear contractual relations between operators at the site, so that the conditions of a "power purchase agreement" can be considered fulfilled.

<sup>93</sup> Annex IV to the CBAM Regulation defines: 'power purchase agreement' means a contract under which a person agrees to purchase electricity directly from an electricity producer;

- Where data for a specific data set are not available for each production process, an appropriate method for determining the required data for each individual production process shall be chosen. For this purpose, either of the following principles shall be applied depending on which principle yields more accurate results:
  - Where over time, different goods are produced one after the other in the same production line, inputs, outputs, and corresponding emissions shall be attributed sequentially to relevant goods/production processes based on the usage time per year for each;
  - Where products are produced in parallel at the same time or in the same production process, inputs, outputs, and corresponding emissions shall be attributed based on a suitable correlating parameter, such as:
    - The mass or volume of individual goods produced; or
    - Estimates based on the ratio of free reaction enthalpies of the chemical reactions involved; or
    - Based on another suitable distribution key that is corroborated by a sound scientific methodology.

Note in particular that for production of hydrogen using electrolysis, the Implementing Regulation gives concrete formulae for attributing emissions to the different products based on molar ratios (see section 7.5.1.2).

Another issue is how to correlate different measurements at installation level and at the level of production processes (or specific physical units of the installation, such as individual boilers, furnaces, etc.). The following text box and *Figure 6-5* give guidance on these issues.

*Text taken from Commission's EU ETS Guidance document No.5 (see footnote 85) with CBAM-related changes.*

One of the most common situations at installations is that a fuel is used in several physical units of the installation. This situation is chosen for its simplicity here to illustrate the basic principles of splitting data into production processes. However, similar approaches apply to all kinds of materials and energy flows, e.g. the attribution of heat or electricity consumption to production processes.

In the example fuel (e.g. natural gas) consumption is determined using continual metering. In installations there is often one central measurement (a main gas meter) where the gas is entering the installation, and further sub-meters at individual process units. The quality of the meters may differ. The main meter is the one of highest importance for economic reasons, and both the operator and the gas supplier are interested in accurate measurement results. In many countries such meters are therefore subject to National Legal Metrological Control (NLMC). But also, where this is not the case, the owner of the instrument (often the gas supplier or grid operator) will ensure regular maintenance and calibration of the instrument (including the instruments for temperature and pressure compensation). For cost reasons the sub-meters are often of lower accuracy (higher uncertainty). Furthermore, there may be some units which have

no separate meters, or the locations of the meters may not coincide with the boundaries of the sub-installations.

The example (see *Figure 6-5*) deals with a fictitious installation where natural gas is used in three physical units serving two production processes. Units 1 and 2 belong to production process 1, and unit 3 belongs to production process 2. The figure shows different situations that can be found in typical installations:

- Case 1: In this simple, cost-effective situation the total amount of gas is metered by the measuring instrument  $MI_{total}$ . This instrument is also used in MMD. The second measuring instrument (MI-1) relates directly to production process 1. Its results should be used for CBAM purposes. The gas quantity for production process 2 is simply calculated as difference between the readings of  $MI_{total}$  and MI-1.
- Case 2: This is another simple case with two meters for two production processes. As there is no meter for the total gas entering the installation, it is to be assumed that the operator determines the gas consumption for calculating the installation-level emissions as sum of the readings of those two meters.
- Case 3: Although here two meters are found, they are located in a way that they cannot be used for determining the production process-level gas consumption. The operator will have to establish a situation more like that in case 1, i.e. the operator should install a sub-meter either at a position like MI-1 or like MI-2 in case 2, and then continue as under case 1.
- Case 4: In this case the gas consumption is “over-determined”, i.e. there are more measuring instruments than required. In such situation it is often observed that the sum of the sub-meters’ readings (MI-1a, MI-1b and MI-2) differs from the reading of the main meter  $MI_{total}$ . As explained above, it is usually assumed that the result of  $MI_{total}$  is the most reliable one, i.e. it represents most accurate available data. Therefore, the production processes’ data must be adjusted such that their sum is identical to the installation-level data. This is achieved by applying a “reconciliation factor” (see below). The readings of the sub-meters are thereafter corrected by multiplying them with that reconciliation factor.

Note: Case 4 assumes that clearly  $MI_{total}$  is the best instrument, and the others are of lower quality. This is not always the case. It might as well be that e.g. MI-2 is of considerably higher quality than the other two sub-meters. In this case it would be justified to use the method described in case 1 instead. The instruments MI-1a and MI-1b would then be used only as corroborating data source.

The calculation for case 4 above is given by the Implementing Regulation as follows:

$$RecF = D_{Inst} / \sum D_{PP}$$

Where:

$RecF$ ... is the reconciliation factor

$D_{Inst}$ ... is the data value determined for the installation as a whole

$D_{PP}$ ... are the data values for the different production processes

The data for each production process are then corrected as follows, with  $D_{PP,corr}$  being the corrected value of  $D_{PP}$ :

$$D_{PP,corr} = D_{PP} \times RecF$$

Figure 6-5: Generic cases explaining basic concepts for splitting data to production processes. “Sub-Inst.” should be read as “production process” (i.e. part of an installation). Please see main text for more information.

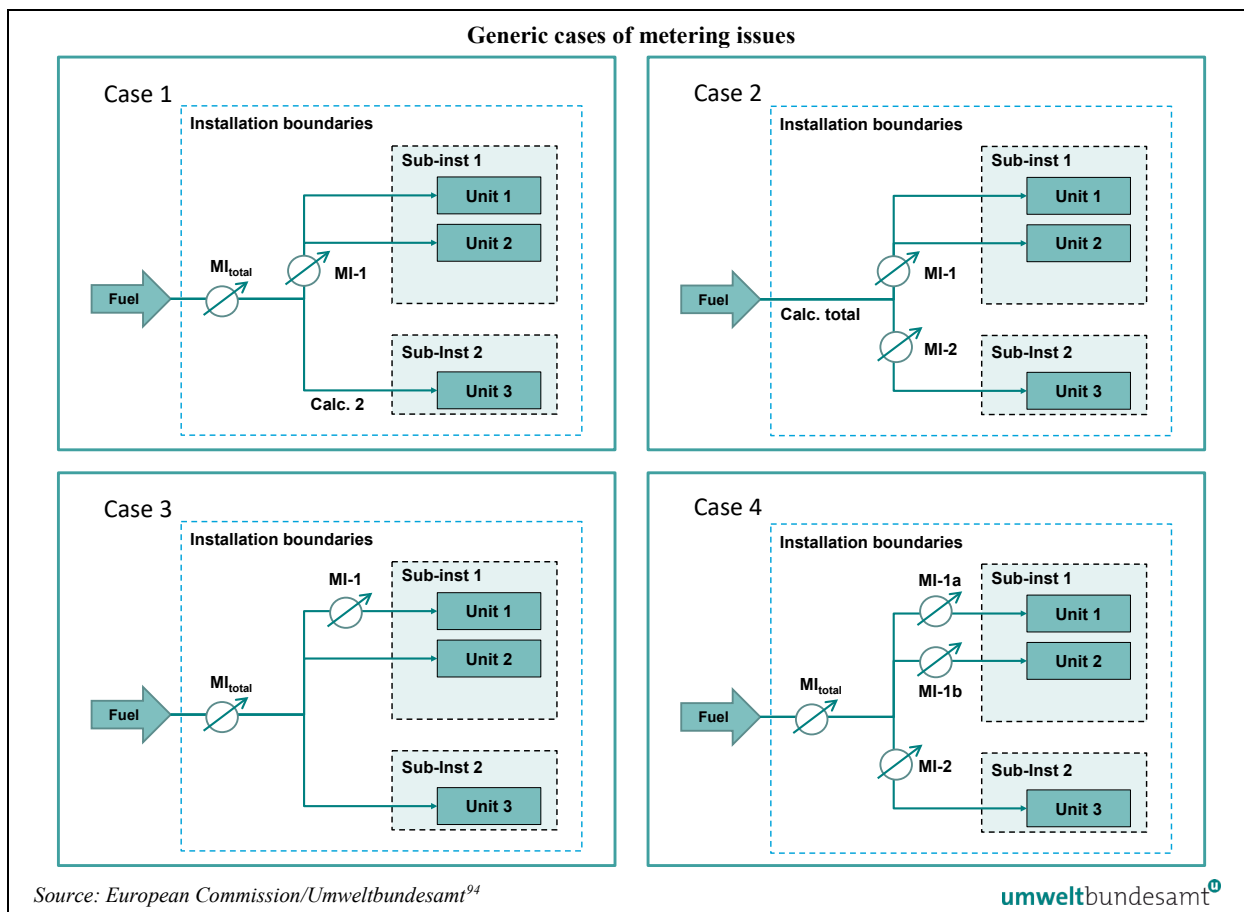

## 6.7.2 Rules for heat energy and emissions

This section discusses the quantification of net measurable heat flows and the calculation of heat emissions factors. Heat is a relevant parameter for attributed emissions of a production process where either heat is received from another installation, another production process or from a central heat supply serving more than one production process, or where heat is exported from the process to other production processes within the installation, or to other installations. ‘Other installations’ here includes also district heating networks.

<sup>94</sup> Commission’s EU ETS Guidance document No.5 (see footnote 85).

The treatment of waste gases, combined heat and power (CHP) and biomass energy and emissions are discussed separately as special cases in the following sections.

#### 6.7.2.1 *Quantification of net heat flows*

Where measurable heat<sup>95</sup> is produced in, consumed by, imported into, or exported from the production process, the net quantity of measurable heat flows and emissions associated with the production of that heat should be monitored and attributed, in line with the methods laid out in Part C, Annex III to the Implementing Regulation.

Measurable heat has the following characteristics:

- All measurable heat is to be understood as ‘**net measurable heat**’, i.e. the amount of heat (enthalpy) consumed by a production process<sup>96</sup> is determined by subtracting the heat content entering a process or external user (as forward flow) and the heat content returning from that process (as return flow);
- The heat flows (forward and return) are transported using a heat transfer medium, which is typically hot water or steam, but may also be heated oil, hot air etc.;
- The heat flows are transported through pipework or ducts (for hot air); and
- The heat flows are or could be measured by a heat meter<sup>97</sup>.

In determining the net quantity of measurable heat consumed by a production process, considerations that may apply include:

- Whether there are imports or exports of measurable heat (cross-boundary heat flows) – the amount of heat imported or exported should be quantified, as the emissions associated with the production of that heat should be monitored.
- The number of production processes consuming the same heat transfer medium – the quantity of heat consumed by each heat consuming process should be determined separately, unless these form part of the same overall production process of the same good.
- The quantity of heat consumed in the operation of the installation’s heat distribution network<sup>98</sup>, as well as heat losses, should be taken into account.

Therefore, a precise monitoring of the net quantity of measurable heat requires measurement of the following parameters:

- Flow rate of the heat transfer medium (volumetric or mass flow) to the process.

---

<sup>95</sup> ‘Measurable heat’ means a net heat flow transported through identifiable pipelines or ducts using a heat transfer medium, such as, in particular, steam, hot air, water, oil, liquid metals and salts, for which a heat meter is or could be installed. ‘Non-measurable heat’ means all heat other than measurable heat.

<sup>96</sup> The heat consumer can be a production process within the installation or outside the installation. Also where heat is used to provide cooling via an absorption chiller, that cooling process is also considered to be a heat consuming process.

<sup>97</sup> ‘Heat meter’ means a thermal energy meter or any other device to measure and record the amount of thermal energy produced based upon flow volumes and temperatures.

<sup>98</sup> Equipment deaerators, make-up water preparation, boiler blow-off or blow-down systems, including any heat losses in the heat distribution pipework.

- State of the heat transfer medium entering the heat consuming process, where “state” includes all parameters relevant for determining the specific enthalpy of the medium:
  - Temperature;
  - Pressure (in case of steam or other gases);
  - Type of the medium (hot water, steam, heated oil etc.);
  - In the case of steam information on saturation or degree of super-heating; etc.
- State of the heat transfer medium leaving the heat consuming process;
- If the flow rate of the returned heat transfer medium (condensate in case of steam) is different from the forward flow, or if unknown, suitable assumptions for its enthalpy are required.

Based on the measured values, you, as the operator, determine the enthalpy and the specific volume of the heat transfer medium using suitable steam tables or engineering software.

Such determination is a difficult task, in particular because industrial installations may have complex heat networks with several heat sources and a multitude of consumers. Therefore, the Implementing Regulation Annex III Part C.1.2 provides several different methods that may be used to determine the net quantity of measurable heat, depending on what data sources are available.

#### 6.7.2.2 *Monitoring requirements*

For monitoring, you, as the operator, should establish processes for direct, and where necessary indirect, measurement of heat flows, using your own measurement system. These procedures should be established, documented in your monitoring methodology documentation, implemented, and maintained through written procedures. These should include the regular checking and review of heat flows in the installation to confirm:

- Any additions or removals of heat consuming units in the installation or production process.
- Any changes in the types of heat flows in the installation i.e. heat imports, production, consumption or exports.
- Any resulting modifications that may be required to the monitoring methodology, if relevant.

### **Methodologies for determining net measurable heat**

Where a production process consumes measurable heat produced within the installation, you, as the operator, may use one of the following methods to determine the net quantity of measurable heat produced and corresponding emissions. Methods 1 to 3 relate to decreasing data quality and monitoring effort. Therefore method 1 is preferred over method 2, which is preferred over method 3 (see section 6.4.4 on selecting best available data sources):



## Method 1: Using measurements

In this method, all relevant parameters listed above are measured or otherwise known. In case steam condensate is not returned or its flow is unknown, a reference temperature of 90°C is to be used<sup>99</sup>. The mass flow rate and heat flow rate of the medium are calculated as below:

$$\dot{m} = \dot{V}/v$$

$$\dot{Q} = (h_{forward} - h_{return}) \cdot \dot{m}$$

Where:

$\dot{m}$ ...is the mass flow rate in kg/s

$\dot{V}$ ...is the volumetric flow rate in m<sup>3</sup>/s

$v$ ... is the specific volume in m<sup>3</sup>/kg

$\dot{Q}$ ...is the heat flow rate in kJ/s

$h_{forward}$ ... is the enthalpy of the transmitted forward flow in kJ/kg

$h_{return}$ ...is the enthalpy of the return flow in kJ/kg

Where the mass flow rate is assumed to be the same for the transmitted and returned heat transfer medium, the heat flow rate is calculated using the difference in enthalpy between the transmitted flow and the return flow.

If the mass flow rates are known to be different, the following consideration should apply, if it is confirmed that:

- Some condensate remains in the product, the respective amount of condensate enthalpy is not deducted.
- Some condensate is lost (leaks or sewerage), the respective amount of condensate is estimated and deducted from the mass flow of the heat transfer medium.

The net annual heat flow can be determined from the above data, by either of the following methods:

- Determine annual average values for the parameters determining the annual average enthalpy of the transmitted and returned heat medium, and multiply with the total annual mass flow;
- Determine hourly values of the heat flow and sum up those values over the annual total operating time of the heat system. Subject to the data processing system, hourly values may be substituted by other time intervals as appropriate.

## Method 2: Calculation of a proxy based on measured efficiency

This method builds on the energy input of all fuels and determines the amount of net measurable heat based on the known efficiency of the boiler, using the following equations:

---

<sup>99</sup> Even if not all condensate is returned to the supply, net measurable heat should be calculated assuming 100% return of the condensate.

$$Q = \eta_H \cdot E_{In}$$

$$E_{In} = \sum_i AD_i \cdot NCV_i$$

Where:

$Q$ ...is the net amount of heat [TJ] produced over the reporting period

$\eta_H$ ...is the measured efficiency of heat production

$E_{In}$ ...is the energy input [TJ] from fuels determined using the second equation over the reporting period

$AD_i$ ...Annual activity data (i.e. quantities consumed) of fuels  $i$  [tonnes or Nm<sup>3</sup>]

$NCV_i$ ...Net calorific value [TJ/t or TJ/Nm<sup>3</sup>] of fuels  $i$

This method refers to the ‘measured efficiency’ of heat production because you, as the operator, are advised to measure it ‘over a reasonably long period’ of time, in order to take into account different load states of the installation.

Alternatively, the efficiency of heat production can be taken from the boiler manufacturer’s documentation (which is the less preferred approach, considering the generic hierarchy of approaches). In this case, the specific part load curve should be taken into account by using an annual load factor, calculated as follows:

$$L_F = \frac{E_{In}}{E_{Max}}$$

Where:

$L_F$ ...is the load factor

$E_{In}$ ...is the energy input [TJ] from fuels determined over the reporting period

$E_{Max}$ ...is the maximum fuel input if the heat producing unit had been running at 100 % nominal load for the full calendar year

In the case of a steam raising boiler the efficiency should be based on a situation in which all condensate is returned. A temperature of 90 °C should be assumed for the returned condensate, if no actual values are available.

### **Method 3: Calculating a proxy based on the reference efficiency**

This approach is meant for situations where boiler efficiencies are not known. This Method is the same as Method 2 but uses a reference efficiency of 70 % as a conservative assumption ( $\eta_{Ref,H} = 0,7$ ).

### **Specific requirements for cross-boundary heat flows**

In the case of cross-boundary heat flows (imports and exports) of measurable heat, you, as the operator, should where possible determine the quantity of these heat flows using your own measuring system, ensuring that the monitoring approach covers the following:

- The quantity of heat imported, where applicable separately for each source, and record its origin.
- Obtained data from the supplier of the imported heat for determining emissions<sup>100</sup>, for the most recent available reporting period.
- The quantity of heat exported, if applicable.

### Heat energy balance

In practical terms, where an installation has complex heat flows i.e. it imports, exports or transfers measurable heat between different production processes on the same installation, the precise split between the different heat production and consumption processes may be determined using a **heat energy balance**, which is used to:

- Determine the precise split for the annual quantities of all flows of measurable heat into and out of the production process.
- Attribute the corresponding fuel input emissions to the production processes, in proportion to the heat split<sup>101</sup>. Where heat losses are not attributed to specific production processes, they shall be attributed proportionally to the split of consumed heat.
- Corroborate overall consumption and corresponding emissions.

### Methodologies for determining fuel emission factors for measurable heat

Where measurable heat is consumed within a production process or exported from it, the heat related emissions are determined by one of the following approaches:

- Approach 1 – used for heat produced in the installation by ways other than CHP;
- Approach 2 – used for heat produced in the installation by CHP;
- Approach 3 – heat was produced outside of the installation.

### Approach 1 – Emission factor of non-CHP measurable heat produced in the installation

---

<sup>100</sup> In principle the emission factor of the fuel mix used by the heat supplier is required.

<sup>101</sup> The CBAM Implementing Regulation Annex III Section F.4: “Where emissions from source streams or emission sources cannot be attributed in accordance with other approaches, they should be attributed using correlated parameters, which have already been attributed to production processes in accordance with Section F.3.1 of this Annex. For that purpose, source stream amounts and their respective emissions are attributed proportionally to the ratio in which those parameters are attributed to production processes. Appropriate parameters include the mass of goods produced, mass or volume of fuel or material consumed, amount of non-measurable heat produced, operating hours, or known equipment efficiencies.”

For non-CHP measurable heat produced from the combustion of fuels within the installation, the emission factor of the relevant fuel mix is determined and the emissions attributable to the production process are calculated as:

$$Em_{Heat} = EF_{mix} \cdot Q_{consumed} / \eta$$

Where:

$Em_{Heat}$ ...is the heat-related emissions of the production process in tCO<sub>2</sub>

$EF_{mix}$ ...is the emission factor of the respective fuel mix expressed as t CO<sub>2</sub>/TJ including emissions from flue gas cleaning, where applicable

$Q_{consumed}$ ...is the amount of measurable heat consumed in the production process in TJ

$\eta$  ... is the efficiency of the heat production process

$EF_{mix}$  is separately calculated using the following equation:

$$EF_{mix} = (\sum AD_i \cdot NCV_i \cdot EF_i + Em_{FGC}) / (\sum AD_i \cdot NCV_i)$$

Where:

$AD_i$ ...is the annual activity data (i.e. quantities consumed) of fuels  $i$  [tonnes or Nm<sup>3</sup>] used for measurable heat production

$NCV_i$ ...is the net calorific value [TJ/t or TJ/Nm<sup>3</sup>] of fuels  $i$

$EF_i$  ...is the emission factors of fuels  $i$  expressed in t CO<sub>2</sub>/TJ.

$Em_{FGC}$  ...are process emissions from flue gas cleaning expressed in t CO<sub>2</sub>.

These parameters are readily available if the calculation-based approach is used for monitoring of direct emissions (see section 6.5.1).

Where a waste gas (for definition see section 6.7.5) is part of the fuel mix used, and where the emission factor of the waste gas is higher than the standard emission factor of natural gas, that standard emission factor is used to calculate  $EF_{mix}$  instead of the emission factor of the waste gas.

### **Approach 2** – heat produced in the installation by CHP

The emissions of the total fuel input to the CHP unit are split in accordance with the method described in section 6.7.4 to give emissions for heat and emissions for electricity.

### **Approach 3** – Emission factor of measurable heat imports, produced outside of the installation

When a production process consumes imported measurable heat that is provided by a third-party supplier outside of the installation or production process, the emissions associated with the production of that heat are requested from the heat supplier; and are to be determined by that supplier using either Approach 1 or Approach 2, as applicable, using the data of the latest available reporting period. If the supplier is subject to an eligible MRV system such data should be available; if not, you as the operator of the heat consuming installation, should ensure the heat delivery contract with the third-party supplier covers this requirement.

If actual emissions data is not available from the heat supplier, then a standard value emission factor should be used, for the fuel most commonly used in the relevant country and industrial sector, and assuming a boiler efficiency of 90%.

## Exceptions

In quantifying net measurable heat, no distinction is made between its different origins, provided it is in scope for the CBAM. However, there are a number of exceptions to this rule (Implementing Regulation, Annex III, Section C.1.3):

- **Heat produced from exothermic chemical processes (not combustion)** – where a production process consumes measurable heat produced from an exothermic chemical process e.g. nitric acid or ammonia production, you should:
  - Determine the amount of measurable heat consumed separately from other measurable heat; and
  - Assign zero CO<sub>2</sub> emissions to that heat consumption.
- **Heat recovered from electricity-driven processes** – you should:
  - Determine the amount of measurable heat consumed that has been recovered from the electricity driven process, such as heat recovered from air compressors and used for supplying hot process water (separately from other measurable heat); and
  - Assign zero CO<sub>2</sub> emissions to that heat consumption.
- **Heat recovered from ‘non-measurable heat’<sup>102</sup>** – to avoid double counting where a production process consumes measurable heat that has been recovered from non-measurable heat generated from fuels e.g. where heat is recovered from kiln exhaust gases, you should:
  - Determine the amount of measurable heat consumed, that has been recovered from the kiln exhaust gases (separately from other measurable heat); and
  - Divide this amount of heat by a reference efficiency of 90% to determine the equivalent energy input for the measurable heat recovered; this energy input is then subtracted from the fuel input into the kiln for the non-measurable heat.

### 6.7.3 Rules for electrical energy and its emissions

The following section covers the quantification of electricity produced within the installation or consumed for the production of goods, the calculation of emissions factors of electricity used for the attribution of emissions to production processes (see section 6.2.2.2 for how produced electricity is relevant in the calculation of direct attributed emissions, and section 6.6 for consumed electricity and attributed indirect emissions).

---

<sup>102</sup> Non-measurable heat means all heat other than measurable heat. Quantities of non-measurable heat are determined by the relevant quantities of fuels used for producing the heat, and the net calorific value (NCV) of the fuel mix

The treatment of CHP electrical energy and its related emissions are discussed separately in section 6.7.4.

### 6.7.3.1 Quantification of electricity amounts

In order to determine the quantity of electricity consumed or produced by a production process, electricity supplies should be metered. Metering should apply to real power, not apparent power (complex power), i.e. only the active power component consumed by the installation should be metered, and the reactive power (or return) component should be disregarded.

As only the consumption by the installation is being considered, any transmission and distribution losses for imported electricity before the installation boundary, i.e. between the grid supply point and the installation boundary, should be disregarded.

### 6.7.3.2 Monitoring requirements

For monitoring, you, as the operator, should establish processes for direct and where necessary indirect measurement of electricity consumed, using your own measurement system. For choosing best available data sources see section 6.4.4.

## **Emission factor for self-supplied electricity or for electricity provided through a direct technical connection**

For **electricity produced within the installation by separate (i.e. non-CHP) production**, the emission factor of electricity  $EF_{El}$  is calculated using the specific fuel mix using the following equation:

$$EF_{El} = ((\sum AD_i \cdot NCV_i \cdot EF_i + Em_{FGC}) / El_{prod})$$

Where:

$AD_i$  are the annual activity data (i.e., quantities consumed) of fuels  $i$  used for the electricity production expressed in tonnes or  $Nm^3$ ,

$NCV_i$  is the net calorific values of fuels  $i$  expressed in TJ/t or TJ/ $Nm^3$ ,

$EF_i$  is the emission factors of fuels  $i$  expressed in t  $CO_2$ /TJ,

$Em_{FGC}$  are process emissions from flue gas cleaning expressed in t  $CO_2$ ,

$El_{prod}$  is the net amount of electricity produced expressed in MWh. It may include quantities of electricity produced from other sources than by combustion of fuels.

These parameters are readily available if the calculation-based approach is used for monitoring of direct emissions (see section 6.5.1).

Where a waste gas (for definition see section 6.7.5) is part of the fuel mix used, the standard emission factor for natural gas given in Implementing Regulation Annex VIII should be used to calculate  $EF_{El}$  instead of the emission factor of the waste gas (unless the EF for the waste gas is lower).

In the case of **electricity produced within the installation through CHP**, the emissions of the total fuel input to the CHP unit are split in accordance with the method described in

section 6.7.4 to give emissions for heat and emissions for electricity. From there, the emission factor for electricity can be calculated.

If the **electricity is not produced by the installation itself, but provided by a ‘directly connected’ installation**<sup>103</sup> –, the electricity emission factor is determined as above (i.e. using the same approaches as if the electricity were produced in the installation), but data must be made available by the electricity supplier).

#### **Emission factor for electricity received from the grid:**

- The default approach is to use a **default factor** provided by the Commission in the CBAM Transitional Registry, which is an average emission factor of the country of origin’s electricity grid, based on data from the International Energy Agency (IEA).
- If you as the operator find it more appropriate, you may use any other emission factor of the country of origin’s electricity grid based on **publicly available data** representing either the average emission factor<sup>104</sup> or the CO<sub>2</sub> emission factor<sup>105</sup>.
- **Actual emission factors may be used in the case of power purchase agreements**, provided that the emission factor is determined as described above.

The determination of specific emission factors by using market-based instruments such as “guarantees of origin” or “green certificates” for renewable energy sources etc. is not allowed.

#### **6.7.4 Rules for combined heat and power**

Combined heat and power (CHP), also referred to as ‘cogeneration’, is the simultaneous generation of heat and power in a single integrated process.

The heat produced from CHP is recovered for a useful heat consuming purpose<sup>106</sup> in the form of hot water, steam or hot air, whilst the power output is usually electricity (may be mechanical power). As this is a single combined process, the split of emissions between heat and power must be calculated using certain assumptions and formulae, to allocate emissions to each output.

The following text box gives the references to the relevant annex sections.

---

<sup>103</sup> An installation can be assumed to be directly connected if it is located at the same site, or has the same operator, and in particular if it has a direct electricity transmission line to the installation producing the goods under the CBAM.

<sup>104</sup> The CBAM Regulation defines: ‘Emission factor for electricity’ means the default value, expressed in CO<sub>2</sub>e, representing the emission intensity of electricity consumed in production of goods.

<sup>105</sup> The CBAM Regulation defines: ‘CO<sub>2</sub> emission factor’, means the weighted average of the CO<sub>2</sub> intensity of electricity produced from fossil fuels within a geographic area. The CO<sub>2</sub> emission factor is the result of the division of the CO<sub>2</sub> emission data of the electricity sector by the gross electricity generation based on fossil fuels in the relevant geographic area. It is expressed in tonnes of CO<sub>2</sub> per megawatt-hour.

<sup>106</sup> Where heat is used to provide cooling via an absorption cooling process, that cooling process is considered as the heat consuming process.

---

*Implementing Regulation references:*

Annex III, Section C Heat flows, C.1 Rules for determining net measurable heat and C.2.2 Emission factor of measurable heat produced in the installation by cogeneration.

Annex III, Section D Electricity, D.3 Rules for determining electricity quantities and D.4.2 Emission factor of electricity produced in the installation by cogeneration.

Annex IX, Efficiency reference values for separate production of electricity and heat, Tables 1 and 2.

---

The Implementing Regulation provides an approach for attributing CHP-related emissions to production processes, which is based on calculating specific emission factors for CHP heat and power<sup>107</sup> outputs. This approach is outlined below, alongside the information required for these calculations.

### **Information required to attribute CHP emissions to production processes**

In order to calculate the split in emissions between heat and power outputs from CHP, you need to collect the following information, as relevant:

(a) Total amount of fuel input into CHP in the reporting period:

$$E_{In} = \sum_i AD_i \cdot NCV_i$$

Where:

$E_{In}$ ...is the energy input from fuels

$AD_i$ ...Activity data (i.e. quantities consumed) of fuels  $i$  [tonnes or Nm<sup>3</sup>]

$NCV_i$ ...Net calorific value [TJ/t or TJ/Nm<sup>3</sup>] of fuels  $i$

These parameters are readily available if the calculation-based approach is used for monitoring of direct emissions (see section 6.5.1).

(b) Heat produced from CHP: the activity level here is the net amount of measurable heat  $Q_{net}$  produced by CHP in TJ during the reporting period. Rules for determining heat flows are given in section 6.7.2.

(c) Electricity produced from CHP: The activity level here is the net amount of electricity (or mechanical energy, where applicable) in TJ, produced by the CHP during the reporting period. The net amount of electricity means the amount of electricity exported (leaving the system boundaries) of the CHP unit, after subtraction of internally consumed electricity ('parasitic load').

(d) Total emissions from CHP: which comprise the emissions from fuel input to CHP, as well as the amount of emissions from flue gas cleaning, in tonnes of CO<sub>2</sub> per year. The total amount of emissions in t CO<sub>2</sub> is calculated using the following equation.

---

<sup>107</sup> The rules regarding electricity apply also to the production of mechanical energy, if relevant.



$$Em_{CHP} = \sum_i AD_i \cdot NCV_i \cdot EF_i + Em_{FGC}$$

Where:

$Em_{CHP}$ ...is the emissions from CHP in the reporting period [t CO<sub>2</sub>]

$Em_{FGC}$ ... process emissions from flue gas cleaning [t CO<sub>2</sub>]

$AD_i$ ,  $NCV_i$  and  $EF_i$  have the same meaning as above under (a)

(e) Average efficiencies for heat and electricity over the reporting period: these dimensionless values are calculated from inputs (a) to (c) above, according to the following equations. However, if inputs (a) to (c) are not available, use instead the efficiencies presented under (f).

$$\eta_{heat} = \frac{Q_{net}}{E_{In}} \quad \text{and} \quad \eta_{el} = \frac{E_{El}}{E_{In}}$$

Where:

$\eta_{heat}$ ...is the average heat efficiency during the reporting period

$Q_{net}$ ...is the net amount of heat [TJ] produced during the reporting period

$E_{In}$ ...is the energy input [TJ] calculated from (a) above

$\eta_{el}$ ...is the average electrical efficiency during the reporting period

$E_{el}$ ... is the net amount of electricity [TJ] produced during the reporting period, from (c) above

(f) Design or standard efficiencies: if it is not technically feasible for you, as the operator, to separately determine the efficiencies of heat and electricity, or this would incur unreasonable cost, then values based on the **manufacturer's technical documentation** (i.e. the **design values**) should be used. If these are also not available, then conservative standard efficiency values of **55% for heat** and **25% for electricity** may be used in the following calculations.

(g) Reference efficiencies: are used in the calculation of the attribution factors for emissions. The reference efficiency values used are for heat production in a stand-alone boiler, and for electricity production without cogeneration. You, as the operator, should select the appropriate fuel-specific electricity and heat reference efficiency value from Tables 1 and 2 in Annex IX of the Implementing Regulation. Those factors are also included in Annex E of this guidance document.

(h) The attribution factors for heat and electricity are then calculated as follows.

$$F_{CHP,Heat} = \frac{\eta_{heat}/\eta_{ref,heat}}{\eta_{heat}/\eta_{ref,heat} + \eta_{el}/\eta_{ref,el}}$$

$$F_{CHP,El} = \frac{\eta_{el}/\eta_{ref,el}}{\eta_{heat}/\eta_{ref,heat} + \eta_{el}/\eta_{ref,el}}$$

Where:

$F_{CHP,Heat}$ ... is the attribution factor for heat

$F_{CHP,El}$ ... is the attribution factor for electricity (or mechanical energy, if applicable)

$\eta_{ref,heat}$ ... is the reference efficiency for heat production in a stand-alone boiler

$\eta_{ref,el}$ ... is the reference efficiency of electricity production without cogeneration

(i) Specific emission factors for CHP-related measurable heat and electricity: The factors to be used for the attribution of related (direct and indirect) emissions to production processes are calculated as follows:

$$EF_{CHP,Heat} = Em_{CHP} \cdot F_{CHP,Heat} / Q_{net}$$

$$EF_{CHP,El} = Em_{CHP} \cdot F_{CHP,El} / E_{El,prod}$$

Where:

$EF_{CHP,heat}$ ... is the emission factor for the production of measurable heat in the CHP unit expressed as t CO<sub>2</sub>/TJ

$EF_{CHP,El}$ ... is the emission factor for the production of electricity in the CHP unit expressed as t CO<sub>2</sub>/TJ

$Q_{net}$ ... is the net heat produced by the cogeneration unit expressed in TJ

$E_{El,prod}$ ... is the electricity produced in the CHP unit expressed in TJ

### 6.7.5 Rules for waste gas energy and emissions

Waste gases result from incomplete combustion or chemical reactions in certain production processes, particularly in the iron and steel sector; for example, coke oven gas (COG), blast furnace gas (BFG) and basic oxygen furnace gas (BOFG), which is also known as ‘converter gas’.

These waste gases are a mixture of CO<sub>2</sub> and incompletely oxidised carbon, usually carbon monoxide (CO), and sometimes hydrogen (H<sub>2</sub>) and further gases, hence they have an energy content recoverable through use as a fuel, as well as containing ‘inherent’ emissions arising from the production process.

The textbox below gives the references to the relevant annex sections.

---

**Implementing Regulation references:**

**Annex II, Production routes for goods, Iron and steel sections 3.11 to 3.16**

**Annex III, Sections B4 requirements for activity data, B5 requirements for calculation factors for CO<sub>2</sub>, B.8 Requirements for monitoring of CO<sub>2</sub> transfers between installations, F. Rules for attributing emissions of an installation to goods.**

**Annex VIII, Standard factors used in the monitoring of direct emissions at installation level.**

---

The recovery and use of waste gases as a fuel to produce electricity or heat is preferable over venting or flaring, as this is energy efficient and avoids emissions that would otherwise be produced through combustion of another fuel to produce this energy.

The following sections cover the quantification of energy and the attribution of direct emissions from waste gases to production processes. The treatment of flares is also discussed below as a special case.

#### *6.7.5.1 Determining activity data for waste gases*

According to the definition given in the Implementing Regulation, a waste gas must satisfy the following three conditions:

- Contain incompletely oxidised carbon – usually in the form of CO.
- Be in a gaseous state under standard conditions (note that it is possible that some of the organic fractions in the waste gas stream may condense under these conditions).
- Occur as a result of one of the processes listed in the definition of process emissions, in particular: (a) the chemical, electrolytic or pyrometallurgical reduction of metal compounds in ores, concentrates and secondary materials; (b) the removal of impurities from metals and metal compounds; (d) chemical syntheses of products and intermediate products where the carbon bearing material participates in the reaction; (e) the use of carbon containing additives or raw materials; (f) the chemical or electrolytic reduction of metalloid oxides or non-metal oxides such as silicon oxides and phosphates.

Waste gases that are recovered are either used in the production process or installation in which they originate, or are transferred to a different production process or installation; for example, in integrated steel works, blast furnace gas and converter gas may be used for both upstream processes (e.g. coke making) and downstream processes (e.g. rolling) as well as for electricity production.

Industrial processes do not rely solely on waste gases and must also operate in stand-alone configurations and hence uses waste gas interchangeably with other fuels e.g. natural gas.

In order to determine the volume of waste gas consumed by a production process, waste gas supplies should be metered.

#### *6.7.5.2 Monitoring requirements for waste gases and flares*

For waste gases, both the calculation factors (NCV, and emission factor or carbon content) and volume in normal cubic metres of the respective waste gas should be monitored as set out in the Implementation Regulation Annex III, sections B.4 and B.5. The relevant requirements are explained in sections 6.5.1.3 and 6.5.1.4, respectively. Furthermore, the rules on selecting best available data sources (section 6.4.4) should be taken into account.

### **Flares**

For flares, monitoring should cover both routine and operational flaring (trips, start-up and shutdown and emergency relieves) in production processes using waste gas.

When calculating emissions from flared gases, you should include:

- Emissions from the combusted flared gas;
- Emissions from the combustion of fuels required to operate the flare i.e. pilot flame and fuels to combust the flared gas; and
- **Inherent CO<sub>2</sub>**<sup>108</sup> in the flared gas source stream.

If accurate monitoring is technically not feasible or would lead to unreasonable costs, a reference emission factor of **0,00393 t CO<sub>2</sub>/Nm<sup>3</sup>** should be used<sup>109</sup>.

#### 6.7.5.3 *Attribution of direct emissions*

Waste gases may be fully used within the same production process in which they were produced, or they may be transferred across the system boundaries of the production process producing the good. For situations where they are not used within the same production process, the formulae given in section 6.2.2.2 are used for calculating the attributed emissions of the production process.

## 6.8 Calculation of embedded emissions of goods

Section 6.2.2 describes the approach to attributing emissions from the installation level to production processes, and section 6.2.2.3 gives the formulae for the calculation of embedded emissions of goods from those attributed emissions. From there it is apparent that for determining embedded emissions of goods, further parameters need to be determined. These are the topic of this section:

- Rules for monitoring type and quantity of CBAM goods for determining the ‘activity level’ of the production process are explained in section 6.8.1;
- Guidance on monitoring of data on precursors is offered in section 6.8.2.

### 6.8.1 *Rules for goods produced*

Following on from section 6.2.2.3 above, you, as the operator, need to determine the activity level of each production process, i.e. the quantity of goods produced at your installation, for a given reporting period. As explained in the section on definitions (6.1.1), quantities of all goods of the same ‘aggregated goods category’ are summed up to give the activity level.

#### 6.8.1.1 *Quantity of goods produced*

The activity level (quantity produced) of a good produced by your installation is calculated as the total mass of goods leaving the production process that meet the product

---

<sup>108</sup> This is CO<sub>2</sub> which is already part of a source stream, see section 6.5.6.1.

<sup>109</sup> The reference EF used here is derived from the combustion of pure ethane, and is used as a conservative proxy for flare gases.

specification for an aggregated CN goods category listed in the CBAM Regulation. This may include both final products and precursors used for the production of other goods.

### **Avoidance of ‘double counting’**

In order to avoid any **double counting** of production, only the quantity of final product leaving the system boundaries of the production process is counted in the activity level for an aggregated goods category. Only products meeting the required specifications, i.e. saleable products or products being used as precursor within the same installation, are taken into account. Hence, the following are excluded from the reported activity level:

- Product that does not meet the desired quality or specification and is returned to the same production process for re-processing.
- Scrap, by-product or waste materials from the production process, including where this is sent to a different installation for re-processing or disposal.

As a consequence, all attributed emissions of the production process are accounted for on saleable goods, while scrap and waste have zero embedded emissions, i.e. double counting is effectively avoided. From environmental point of view, this incentivises a decrease of material consumption, or the avoidance of scrap and waste, as a process producing little scrap will have lower embedded emissions.

#### *6.8.1.2 Monitoring requirements*

As an operator, you should first identify all goods produced at your installation, along with their applicable CN codes. Procedures should be put in place to track the list of goods and to determine the quantity of goods produced by each production process. These procedures should be documented in the installation’s monitoring methodology documentation. Key aspects are discussed below.

### **Tracking of goods**

A comprehensive list of products (and precursors) produced in the installation should be established and regularly reviewed, including the following:

- The product specifications of the listed goods should be reviewed to make sure these match the CN codes given in Annex I to the CBAM Regulation, and Table 1 section 2 of Annex II to the Implementing Regulation (see section 5 of this guidance document).
- The listed goods are to be correctly attributed to the relevant production routes for the production processes of the installation.
- The list of goods is to be updated to include any new goods produced for the first time. The CN code for the new product is to be identified.
- If the new product belongs to an aggregated goods category previously not found in the installation, you as the operator will have to define an additional production process for separate monitoring of the embedded emissions of that good, except if the ‘bubble approach’ allows you to include the new good in an existing production process (see section 6.3).
- Any related inputs, outputs and emissions for the new good produced are to be attributed to the relevant production process.

The addition of a new type of good may change the existing attribution of inputs, outputs and emissions to existing products and precursors at an installation, and so the review should also take this into account. The written monitoring methodology documentation should be updated without undue delay, and the monitoring using the updated methodology is to start immediately.

### **Methods to determine the quantity of goods**

In principle, the same methods like for the monitoring of activity data for source streams apply also to the quantification of goods produced. Details are discussed in section 6.5.1.3. The rules for selecting best available data sources (section 6.4.4) apply.

Since quantities of produced and sold goods are usually essential elements of a company's financial report, such data should be available for the CBAM without additional effort. Operators should ensure consistency of their CBAM data with financially audited reports, and use those reports for corroboration of their embedded emissions calculation.

### **Monitoring the quality of goods**

Depending on the industry sector and the goods produced, further parameters are to be reported by the EU importer in the quarterly CBAM report. Therefore, you as the operator should be able to provide the relevant information to the importer. These additional reporting requirements are listed in section 7 for each sector. Some of these parameters require quality information of your products, like for example the clinker content of cement, the content of certain alloy elements in steel, the amount of scrap used for the production of steel and aluminium, the concentration of nitric acid or of hydrous ammonia, and the content of different nitrogen forms in mixed fertilizers.

As this is qualitative information, in principle the rules given for calculation factors in section 6.5.1.4 apply. This means that – where relevant – laboratory analyses may have to be carried out. However, in many cases such analyses will be carried out anyway as part of the production quality control, for ensuring the client's specifications are met. In some cases it may be more appropriate to calculate the required parameters based on a mass balance of process inputs. However, it is assumed that determining the required parameters will be possible without unreasonable effort. The methods used should be contained in the monitoring methodology documentation, and regularly reviewed.

**Note that the differentiation of goods by their quality makes it necessary to provide data to importers on a more detailed level than just CN codes.** For example, if you sell three different grades of mixed fertilizers, you will have to provide three separate goods with the same CN code with different embedded emissions and composition data in the communication template you make available to EU importers.

### **6.8.2 Rules for monitoring of precursor data**

In order to perform the calculation for embedded emissions of complex goods as outlined in section 6.2.2.3, the embedded emissions of precursor materials need to be added to the direct and indirect emissions attributed to the production process. The following rules apply.

- Where relevant precursors are produced within the same installation within the same production process using a ‘bubble approach’ (see section 6.3), no separate monitoring and calculation is required. Only precursors from other production processes or obtained from other installations need to be monitored.
- Where a relevant precursor is produced within the same installation, using a separate production process to the production of the complex good:
  - The quantity of relevant precursor consumed by each of the installation’s complex good production processes should be determined.
  - The specific direct and indirect embedded emissions of the precursor need to be calculated separately, and should be the average over the reporting period.
- For relevant precursors obtained from other installations:
  - The quantity of precursor consumed and embedded direct and indirect emissions should be determined and/or accounted for separately, for each installation from which the relevant precursor is sourced.
  - The precursor specific direct and indirect embedded emissions have to be communicated by the operator of the other installation supplying the precursor. In order to ensure data completeness, precursor producers should use the voluntary communication template outlined in section 6.11 for reporting data on the precursor supplied.
  - However, if these data are inconclusive then default values may be used for calculating the total embedded emissions resulting from the quantity of precursor consumed, but only where the precursors contribute to no more than 20% of total embedded emissions (see section 6.9).



If precursor materials are obtained from other installations, Section E of Annex III to the Implementing Regulation requires you as the operator producing a complex good to request the following data from the producer of the precursor material:

- The country of origin of the imported goods;
- The installation where it was produced, identified by
  - the unique installation identifier, if available;
  - the applicable United Nations Code for Trade and Transport Location (UN/LOCODE) of the location;
  - an exact address and its English transcript; and
  - the geographical coordinates of the installation.
- The production route used as defined in Section 3 of Annex II to the Implementing Regulation;
- The values of applicable specific parameters required for determining the embedded emissions, as listed in Section 2 of Annex IV to the Implementing Regulation;
- Specific embedded direct and indirect emissions of the precursor as average over the most recent available reporting period, expressed in tonnes CO<sub>2</sub>e per tonne of precursor;

- The start and end date of the reporting period used by the installation from which the precursor was obtained;
- The information on the carbon price due for the precursor, if relevant.

If the Commission’s communication template is used, it will be automatically ensured that these data are complete.

## 6.9 Use of default factors and other estimation methods

Whenever you as an operator do not have all necessary data available for calculation of embedded emissions, you need to close those data gaps by the best available data or estimation method. For minor data gaps in your installation’s data (e.g. missing an analysis of one batch of fuel), you should have a suitable estimation method in your monitoring methodology documentation (see section 6.9.3).

For other situations, there are “**default values**” for the **specific direct and indirect emissions** of goods and precursors, which you as the operator can use for your purchased precursors under certain conditions (see section 6.9.1), and which can also be used by EU declarants for a limited time at the start of the transitional period. Furthermore, default values for **electricity emission factors** for calculating indirect emissions are made available by the Commission (see section 6.9.2).

### 6.9.1 *Default specific embedded emission values*

Default emission factors values have been calculated by the European Commission (for both direct and indirect emissions where appropriate) by CN code. These are provided on the European Commission’s dedicated website for the CBAM and a taxonomy is given in sector tables in **Annex C** of this document:

- Default values given at a 4-digit CN code level apply to all goods falling within this 4-digit CN code category (i.e. independent of the digits following these first 4 digits).
- Default values supplied at a 6-digit CN code level apply to all goods falling within this 6-digit CN code category.
- Default values supplied at an 8-digit CN code level only apply to this specific 8-digit CN code good – in most case these 8-digit codes are for the steel industry, reflecting the range of different production routes and alloying elements used.
- In many cases the same default value applies to several CN codes, as listed in Annex C.

These default values can be used as the specific direct or indirect embedded emissions of precursor goods that are used as inputs and consumed in the production process for other CBAM goods, where the actual emissions intensities for these precursor goods are not available. This is usually the case when your precursor supplier does not communicate the relevant data within the required timeframe.

Articles 4(3) and 5 of the CBAM Implementing Regulation **limit the use of default values**:



- Without quantitative limit until 31 July 2024 (i.e. for use in the first three quarterly CBAM reports). Thereby, EU importers are allowed to use these values to ensure their compliance with the CBAM requirements in case that they do not receive relevant data from operators of installations producing CBAM goods in time. For you as an operator, this allows you to fill data gaps regarding your purchased precursors for data that you communicate to your importers for the same time period.
- Without time limit, but quantitatively limited: For complex goods, up to 20% of the total embedded emissions may be determined using estimations. Using default values provided by the Commission would qualify as ‘estimation’. For you as operator this offers two simplification options for your monitoring:
  - If you produce complex goods and purchase precursors that contribute less than 20% of the total embedded emissions, you may use the default values instead of requesting the supplier to provide the relevant data.
  - If the majority of the embedded emissions of your product are contributed by the precursors (e.g. if you purchase steel rods for producing screws and nuts from them), you may apply ‘estimations’ to your own production process, provided that you receive reliable data on the precursors’ embedded emissions from their producers, and that your own production process contributes not more than 20% to the total embedded emissions. In this case, ‘estimation’ for your own emissions may entail using monitoring approaches from other MRV systems, if the methods given in Annex III to the Implementing Regulation are too burdensome for your installation.

Participants wishing to use the default values determined by the Commission (see Annex C) should note that these are set at a relatively high emissions intensity level and, therefore, it may be more advantageous to use the actual values for precursor goods where these are available. Furthermore, the default values can serve as a tool for you to check the plausibility of your actual data, as the default values are determined as global average values based on publicly available sources.

### **6.9.2 *Default emission factors for grid electricity***

For the rules on the use of default values for the electricity grid’s emission factor for the purpose of calculating indirect embedded emissions, please see section 6.7.3.2).

### **6.9.3 *Minor data gaps in installation’s monitoring data***

Where data gaps occur in everyday activities of monitoring emissions in the installation, the Implementing Regulations requests that substitute data shall consist of conservative estimates, i.e. by data that ensures that emissions are not under-estimated, and that activity levels (production data) are not over-estimated. The following guidance can be given:

- If a calculation factor in a calculation-based methodology is missing (e.g. because a sample has not been taken in time or no laboratory analysis was made), substitution by a standard value will be simple (see section 6.5.1.4).

- If activity data (section 6.5.1.3) are missing (e.g. because a truck was not weighted), it may be a good idea to use the average mass of similar truck loads in the same reporting period, adding some supplement (e.g. one standard deviation) to the data to ensure the estimate's conservativeness.
- If a measurement instrument is not functioning properly, it shall be replaced as soon as possible. In the meantime, an instrument exhibiting higher uncertainty may be used, if available. If no other instrument is available, the missing data should be estimated conservatively. For flow meters, an average flow rate determined during the same reporting period might be used, adding some supplement (e.g. one standard deviation) to the data to ensure the estimate's conservativeness. In other cases, e.g. heat measurements, an estimate may be based on the energy efficiency of the process determined over the reporting period, adding some supplement.
- The chosen approach for filling the data gap should be put down in the monitoring methodology documentation for future use. Furthermore, a regular review should be performed to identify options to avoid similar data gaps in the future (e.g. by ensuring that reserve units are kept in stock for critical measurement instruments).

## 6.10 Reporting the effective carbon price due

In order to ensure the fair treatment of goods produced in different installations in different jurisdictions, it is necessary for you, as an installation operator, to inform to the importer of the **effective carbon price**<sup>110</sup> due where CBAM goods are produced, before the CBAM obligation for the CBAM goods produced can be determined.

The '**effective carbon price**' is the actual price per tonne due for the installation's production processes as well as for relevant precursor materials used in the production and should take into account:

- The actual price of a tonne CO<sub>2e</sub> in the carbon pricing scheme in the jurisdiction;
- The coverage of emissions of the production processes in the carbon pricing scheme (direct, indirect, types of GHG, etc.)
- Any applicable 'rebates'<sup>111</sup>, i.e. the amount of free allocation (in the case of an ETS) or any financial support, compensation or other form of rebate received in that jurisdiction, per tonne of the product relevant for the CBAM; and
- In the case of complex goods, the carbon price due (after any rebates received) of any relevant precursor materials consumed in the production process.

---

<sup>110</sup> The CBAM Regulation defines: '*carbon price*' means the monetary amount paid in a third country, under a carbon emissions reduction scheme, in the form of a tax, levy or fee or in the form of emission allowances under a greenhouse gas emissions trading system, calculated on greenhouse gases covered by such a measure, and released during the production of good.

<sup>111</sup> The Implementing Regulation defines: '*rebate*' means any amount that reduces the amount due or paid by a person liable for the payment of a carbon price, before its payment or after, in a monetary form or in any other form.



In the transitional period this is a reporting obligation for importers; however, in the definitive period disclosure of this information will give importers **a rebate in the amount otherwise due to be paid** by the person liable for the CBAM obligation.

If your installation is subject to a carbon price, you will have to collect information on the carbon price due before the CBAM obligation, in such a way that you can attribute it to production processes and CBAM goods categories in a similar way as you attribute emissions to the goods.

If there is a carbon pricing system in operation in the country (or region or smaller jurisdiction) where your installation is situated, then the actual price per tonne CO<sub>2e</sub> that has already been paid needs to be monitored and relevant information communicated to importers for their CBAM quarterly report.

The procedure for monitoring and calculating the effective carbon price should be included in the monitoring methodology documentation; additionally, if relevant precursors from another installation are used in the production process, you also need to obtain the same information from the supplier for each precursor good supplied.

The carbon price due may be attributed to a production process and aggregated goods category in a similar way to how specific embedded emissions are calculated, and should be **expressed as euros per tonne of CBAM good**. This is calculated as follows:

- Establish the total quantity of emissions emitted and the carbon price, and from this calculate the total carbon price due in the reporting period. This calculation should be carried out at level of the production process<sup>112</sup>.
- Divide the total carbon price due by the tonnes of CBAM good produced per production process to get price per tonne of CBAM good.

For complex goods, where relevant precursors are consumed by the production process, the carbon price due by the supplier should be added to that determined for the complex CBAM good, and the resulting carbon price calculated.

If the supplier of the precursor does not provide the required information, you have to assume the carbon price due for the precursor to be zero.

The two main types of carbon pricing system in operation are an **emissions trading system** (ETS) or a **carbon price in the form of a tax, levy or fee**. In these cases the type of information that operators should report are as follows:

- **Carbon price under an Emission Trading System (ETS):**
  - The annual average price of allowances/certificates relating to one metric tonne of CO<sub>2e</sub> in the applicable currency;

---

<sup>112</sup> Assuming that all emissions covered by the CBAM are also covered by the carbon price, you only need to split the carbon price due at installation level proportionally to the split of the emissions to production processes. However, if the carbon price applies to only a part of the CBAM emissions (e.g. if process emissions are not covered by a tax on fuels only), a more appropriate approach such as a split per source stream may be required.

- Details of the ETS rules<sup>113</sup>, such as whether it applies to direct and/or indirect emissions;
  - The total emissions for which you had to surrender allowances or certificates;
  - The total number of allowances or certificates which you received for free, as a ‘free allocation’;
  - The resulting difference between emissions and free allocation. If the latter exceeds the emissions, the carbon price due is to be reported as zero.
- **Carbon price in the form of a tax, levy or fee :**
    - The annual average amount of tax, levy or fee relating to one metric tonne of CO<sub>2</sub>e in the applicable currency. If the amount is different e.g. for different fuels used, a weighted average rate corresponding to the fuel mix of your installation is to be determined for each reporting period;
    - Details on the rules applicable<sup>113</sup> to the tax, levy or fee, such as whether it applies to direct and/or indirect emissions or specific processes or fuels, etc.;
    - The total emissions for which you had to pay the carbon price under the tax, levy or fee;
    - Any rebate you were allowed to apply to your payment of the carbon tax, levy or fee;
    - The resulting total carbon tax paid. If the rebate exceeds the tax rate before the application of the rebate (or refunding), the carbon price due is to be reported as zero.

Other types of carbon price system may be possible, such as Results-Based Climate Finance (RBCF) but these are not typical of industry sectors, and are not eligible under the CBAM legislation.

The exchange rate between the applicable currency of the carbon price due and euros will be applied automatically in the CBAM Transitional Registry when the CBAM Report is entered by the reporting declarant, using the average yearly exchange rate for the preceding year.

During the transitional period, importers report details of both the **carbon price due** and also the **CBAM products covered by the price due**, as reported by the operators producing the CBAM goods.

## 6.11 Reporting template

This section outlines how you, as an operator, should account for and report production and embedded emissions during the CBAM transitional period. Note that there is no formal reporting obligation like in other carbon pricing systems for you as an operator, but only the need to *communicate* the emissions data to EU importers of your goods. The textbox

---

<sup>113</sup> Importers will have to provide a description and indication of legal act – i.e. provide the regulation reference, ideally as internet link. Therefore, you should also provide this information.

below signposts the key sections in the Implementing Regulation for reporting, relevant for the CBAM transitional period.

---

*Implementing Regulation references:*

**Annex II, Section 1 Definitions.**

**Annex III, Section F Rules for attributing emissions from an installation to goods.**

**Annex III, Section I Communication by the operator of the data for the use by the reporting declarant in the CBAM report.**

**Default values for the calculation of embedded emissions, determined by the European Commission and published on their dedicated website for the CBAM.**

---

Installation operators are responsible for monitoring and reporting the embedded emissions of goods they have produced and are exporting to the EU, to the importers of these goods. Importers or ‘reporting declarants’ must report on the embedded emissions of imported goods on a quarterly basis during the transitional period.

The contents of the operator’s **recommended ‘Emissions data communication’** to reporting declarants is provided in the Implementing Regulation Annex IV. Reporting declarant’s use the information in this communication to complete their CBAM reports on the CBAM Transitional Registry. The structure of the CBAM report is given in the Implementing Regulation Annex I.

An **electronic version** of the **Emissions data communication** template, in spreadsheet format, has been developed by the European Commission to help you, as an operator, **share the necessary embedded emissions data with reporting declarants**. This is introduced by the following Figure 6-6 and the spreadsheet tool is available from the European Commission’s dedicated website for the CBAM.

Figure 6-6: Voluntary electronic data communication template – Contents page

	B	C	D	E	F	G	H	I	J	K	L	M	N
2				Navigation Area:		<a href="#">Table of contents</a>	<a href="#">Further Guidance</a>	<a href="#">Summary Processes</a>	<a href="#">Summary Products</a>				
3	Table of contents												
4													
6	<b>Sheet "Table of contents"</b>												
7													
8	a. <a href="#">Sheet "Table of contents"</a>												
9													
10	b. <a href="#">Sheet "Guidelines &amp; conditions"</a>												
11													
12	A. <a href="#">Sheet "A_InstData" - General information, production processes and purchased precursors</a>												
13	1 <a href="#">Reporting period</a>												
14	2 <a href="#">About this report</a>												
15	3 <a href="#">Verifier of this report, if applicable</a>												
16	4 <a href="#">Aggregated goods categories and relevant production processes</a>												
17	5 <a href="#">Purchased precursors</a>												
18													
19	B. <a href="#">Sheet "B_Emlnst" - Installation's emission at source stream and emission source level</a>												
20	1 <a href="#">Source Streams (excluding PFC emissions)</a>												
21	2 <a href="#">PFC Emissions</a>												
22	3 <a href="#">Emissions Sources (Measurement-Based Approaches)</a>												
23													
24	C. <a href="#">Sheet "C_Emissions&amp;Energy" - Installation-level GHG emissions and energy consumption</a>												
25	1 <a href="#">Fuel balance</a>												
26	2 <a href="#">Greenhouse gas emissions balance</a>												
27													
28	D. <a href="#">Sheet "D_Processes" - Production level and attributed emissions for SEE calculation</a>												
29	1 <a href="#">Data input for the determination of the specific embedded emissions</a>												
30													
31	E. <a href="#">Sheet "E_PurchPrec" - Purchased precursors for SEE calculation</a>												
32	1 <a href="#">Data input for the determination of the specific embedded emissions</a>												
33													
34	F. <a href="#">Sheet "F_Tools" - Tools for facilitating reporting</a>												
35	1 <a href="#">Cogeneration Tool</a>												
36	2 <a href="#">Tool for calculation of the carbon price paid</a>												
37													
38	G. <a href="#">Sheet "G_FurtherGuidance" - Further guidance on specific sections in this template</a>												
39	1 <a href="#">General guidance</a>												
40	2 <a href="#">Source streams and emission sources</a>												
41	3 <a href="#">Attribution of emissions to production processes</a>												
42	4 <a href="#">Summary of products</a>												
43													
44													
45	The following two sheets summarise the results at process and product level, respectively:												
46	<a href="#">Summary of production processes</a>												
47	<a href="#">Summary of products</a>												
48													
49	The following sheet summarises the main information to be communicated to the reporting declarant:												
50	<a href="#">Communication with reporting declarant</a>												
51													
52													
53													
54	Language version:					English Version (Original)							
55	Reference filename:					CBAM SEE Communication_UBA_en_200723.xls							
56													
57	<b>Information about this file:</b>												
58	Installation name:					Test installation							
59	Reference period:					from: 01.01.2023 to: 31.12.2023							

Key features include:

- User-friendly navigation and automatic calculation of CBAM embedded emissions data from data inputs, showing how attributed emissions have been calculated for each production process.
- Covers information for both Parts 1 and 2 in the operators’ report, identifies what data is required for the reporting declarants to complete the CBAM report and what data is optional, and provides guidance on how to use the template and on the different calculations performed.
- Tools for facilitating reporting, for attributing emissions between heat and electricity for CHP/cogeneration and for calculating the carbon price due.
- Summary sheets providing the main information on production processes and products to be communicated to the reporting declarant for their CBAM Reports.

### 6.11.1 For operators

The operator’s Emissions data communication template has two parts, the first contains all necessary information required by the reporting declarant to compile their CBAM report, whilst the second part is an optional section that is a **recommended improvement** measure to provide **greater transparency** of the data reported under Part 1. The contents are outlined in the following *Table 6-2* below.

Table 6-2: Contents of the operators' recommended 'emissions data communication' to importers

Template	Summary of information required for the transitional period
<b>Part 1 General information</b>	<p data-bbox="424 297 1366 331">– <b>Includes the data to be communicated to the reporting declarant.</b></p> <ul style="list-style-type: none"> <li data-bbox="472 365 1457 472">– Installation data, comprising identification and location details for the operator's installation, and contact details for the operator's authorised representative.</li> <li data-bbox="472 506 1457 577">– The production processes and routes under each aggregated goods category at the installation.</li> <li data-bbox="472 611 1457 683">– For each aggregated goods category or separately for each good by CN code: <ul style="list-style-type: none"> <li data-bbox="507 716 1457 824">– The direct and indirect specific embedded emissions of each good; and for SEE indirect detail on how the emission factor was determined and the information source used;</li> <li data-bbox="507 857 1457 1010">– Information on what data quality and methods (calculation-based, measurement-based, other) were used for determining embedded emissions, and whether this was based fully on monitoring, or if default values were used;</li> <li data-bbox="507 1043 1457 1115">– If default values were used, a short description why these were used instead of actual data;</li> <li data-bbox="507 1149 1457 1220">– Information on additional sector-specific reporting parameters for goods produced, if required; and</li> <li data-bbox="507 1254 1457 1357">– If applicable, information on a carbon price due, and separately for any precursors obtained from other installations, by the precursors' country of origin.</li> </ul> </li> </ul>
<b>Part 2 Optional information</b>	<p data-bbox="424 1391 1457 1462">– <b>Provides greater transparency of the data under Part 1, and allows the reporting declarant to carry out validation checks on Part 1.</b></p> <ul style="list-style-type: none"> <li data-bbox="472 1496 1457 1680">– The total emissions of the installation, including: activity data and calculation factors for each source stream used; emissions of each emission source monitored using a measurement-based methodology, and emissions determined by other methods; and if applicable, any CO<sub>2</sub> imports or exports to other installations, for the reasons outlined above.</li> <li data-bbox="472 1713 1457 1785">– A 'heat balance' of imported, produced, consumed and exported measurable heat, and similarly balances for waste gases or electricity.</li> <li data-bbox="472 1818 1457 1890">– A list of all relevant goods by CN code produced by the installation, including precursors not covered by separate production processes.</li> <li data-bbox="472 1924 778 1957">– For precursor goods:</li> </ul>

Template	Summary of information required for the transitional period
	<ul style="list-style-type: none"> <li>– The quantity received from elsewhere.</li> <li>– Their specific direct and indirect embedded emissions (as reported by other operators).</li> <li>– The quantity used in each production process, excluding precursor goods produced in the same installation.</li> <li>– For attributed direct and indirect emissions: information on how the attributed emissions of each production process were calculated; the activity level and attributed emissions of each production process.</li> <li>– A short description of the installation, covering: relevant and non-relevant (out of scope) production processes; <ul style="list-style-type: none"> <li>– The main production processes taking place at the installation and any production processes not covered for the purposes of the CBAM;</li> <li>– The main elements of the monitoring methodology being used; and</li> <li>– What measures to improve data quality have been taken, in particular whether any form of verification (in the definitive period) was applied.</li> </ul> </li> <li>– information on the electricity emissions factor in the power purchase agreement, where appropriate.</li> </ul>

---

*Source: Annex IV to the Implementing Regulation.*

In order to supply the recommended optional data under Part 2 above, you, as an operator may need to supply supplementary files with this information, to the reporting declarant.

### **6.11.2 For reporting declarants**

During the transitional period reporting declarants should submit CBAM reports on the CBAM Transitional Registry, using the structure laid out in the Implementing Regulation Annex I ‘Information to be submitted in the CBAM reports’. The information on embedded emissions relevant for the CBAM report is supplied by the Part 1 of the operator’s Emissions data communication, listed in *Table 6-2* above.

If the voluntary electronic data communication template is used by the operator to communicate the information on embedded emissions to you, as the reporting declarant, then information required for the CBAM quarterly report is found in the ‘Summary Communication’ sheet at the back of the spreadsheet.





## 7 SECTOR SPECIFIC MONITORING AND REPORTING

Section 5 deals with the specification of products covered by the CBAM and the relevant production routes. This section now continues with sector-specific details, in particular by adding sector-specific monitoring and reporting requirements, and by providing elaborated examples for each sector.

While this guidance document is intended primarily for use by operators who produce tangible goods falling under the CBAM, section 7.6 contains also some information for importers of electricity as good under the CBAM.

**Note on examples:** While the examples are intended primarily for readers from the specific sectors, readers are invited to also learn from the other examples, as each example also contains concepts which may be of interest to other sectors. In particular:

- Section 7.1.2 (Cement sector) provides an example of a step-by-step approach to splitting an installation into production processes;
- That example is further elaborated in section 7.1.3, there the example is described alternatively using the ‘bubble approach’. Furthermore, it demonstrates that a mix of materials (limestone and other minerals) can be jointly monitored as ‘raw meal’, which suits better the existing situation of the installation.
- The first example of the steel sector (7.2.2.1) deals with an integrated steel works. Here the ‘bubble approach’ for defining production processes with a view of minimising monitoring efforts is demonstrated. Furthermore, electricity generation from waste gases and the use of the plant’s own electricity emission factor for indirect emissions is demonstrated (where a part of electricity also comes from the grid).
- The second steel example (section 7.2.2.2) deals with the production of high-alloy steel using the Electric Arc Furnace route. Here additional precursors are purchased and added to the installation’s own emissions. Furthermore, additional reporting requirements within the CN code are discussed. As an additional feature, the calculation of embedded emissions of complex goods is performed in two different ways: in the first case, the total embedded emissions are calculated before dividing by the activity level; in the second case, the calculation is carried out using specific embedded emissions of the precursors.
- Both steel examples use a mass balance calculation, as the steel products and slags contain carbon that is not emitted as CO<sub>2</sub>.
- The fertilizer example (section 7.3.2) shows a situation where almost the complete embedded emissions come from the two purchased precursors ammonia and urea. Note that in the example all the emissions are only CO<sub>2</sub>, although in this sector N<sub>2</sub>O emissions would be relevant, too. In case the installation would use nitric acid as a precursor (e.g. substituting the sulphuric acid of the example), then the N<sub>2</sub>O emissions embedded in the nitric acid would be added like any other embedded emissions.
- The example for aluminium (section 7.4.2) shows a situation where a part of the installation (the production of prebaked anodes) is not subject to the CBAM, and the related source streams have to be properly separated.

- Hydrogen example No.1 (section 7.5.2.1, production route: methane steam reforming) demonstrates how exported heat is to be taken into account for attributing emissions.
- Hydrogen example No.2 (section 7.5.2.2, chlor-alkali electrolysis) is a process where only indirect emissions apply. They are split between the three main products of the process as required by the Implementing Regulation.

Throughout all examples, different assumptions are made for the electricity received from the grid, resulting in different emission factors for electricity. Those different values may serve to learn about orders of magnitude of these factors.

## 7.1 Cement sector

The textbox below signposts sector-specific sections in the Implementing Regulation, relevant for the CBAM transitional period.

---

### Implementing Regulation references:

- **Annex II**, Section 3 – Special provisions and emissions monitoring requirements by production route. Sub-sections 3.2 to 3.5 (cement sector aggregated goods categories).
  - **Annex III**, Section B – Monitoring of direct emissions at installation level, sub-section **B.9.2**. Sector specific requirements, additional rules for process emissions from the cement sector, covering: **B.9.2.1** additional rule for Method A (input based); **B.9.2.2** additional rule for Method B (output based); **B.9.2.3** additional rule for emissions related to discarded cement kiln dust/bypass dust.
  - **Annex IV**, Section 2 – Sector specific parameters for CBAM goods that should be reported by producers of goods to importers, in the Emissions Data Communication.
- 

### 7.1.1 *Sector-specific requirements for monitoring and reporting*

Direct and indirect embedded emissions should be monitored in line with the methodology set out in the Implementing Regulation and outlined above.

#### 7.1.1.1 *Emissions covered*

Relevant direct emissions that should be monitored and reported for the cement sector are:

- Carbon dioxide emissions (direct) from the fuel combustion process<sup>114</sup> from stationary plant only (excludes emissions from any mobile plant such as vehicles).
- Carbon dioxide emissions (direct) from the process, resulting from:
  - Thermal decomposition of carbonate containing raw materials (such as limestone, dolomite etc);

---

<sup>114</sup> For both kiln and non-kiln fuels. Cement kiln fuels include conventional fossil fuels such as natural gas and coal, alternative fossil-based fuels such as petroleum coke or waste chipped vehicle tyres, and biomass fuels (biomass wastes). Non-kiln fuels refers to fuels used outside of kilns e.g. to calcine clays in flash calciners, and where cement materials are dried.

- Non-carbonate carbon content in the raw materials (such as carbonaceous clay, limestone, shale);
- Alternative raw material (such as fly ash used in the raw meal), or from any fossil/biomass additives used.
- Discarded cement kiln dust (CKD) or bypass dust.
- Carbon dioxide emissions (direct) resulting from the production of measurable heating (e.g. steam) and cooling that is consumed within the system boundaries of the production process, regardless of the location of the production of the heat (i.e. from on-site generation or from imports from off-site).
- Carbon dioxide emissions (direct) resulting from emissions control (e.g. from carbonate raw materials such as soda ash used for acidic flue gas cleaning). This is included for any good where this is applicable.

Direct emissions from the different source streams above are not reported separately but are added together to result in the total direct emissions for the installation or production process.

Indirect emissions from electricity consumed must be reported separately from direct emissions.

#### 7.1.1.2 Additional rules

### Determining process emissions

For determining direct emissions from cement clinker production, additional rules also apply for the monitoring of process emissions from raw meal components depending on whether the **activity data** refers to:

- Process **input** material (e.g. limestone) based on:
  - the carbonate content of the process input (calculation **Method A**); and
  - an adjustment is made for cement kiln dust (CKD) or bypass dust that leaves the kiln system.
- Process **output** material e.g. the amount of clinker produced (calculation **Method B**).

Note that both methods are considered equivalent, i.e. you, as the operator, should choose the method which leads to the more reliable data, which is more applicable for your equipment, and that avoids unreasonable costs. Calculation methods A and B are further described in section 6.5.1.1 of this guidance document.

### Calculation of emissions related to discarded CKD or bypass dust

As the operator, you shall add CO<sub>2</sub> process emissions, from bypass dust or cement kiln dust (CKD) leaving the kiln system, corrected for a partial calcination ratio of CKD.

- Minimum requirements: An emission factor of 0,525 t CO<sub>2</sub>/t dust is applied.



**Recommended improvement:** The emission factor (EF) is determined at least once annually in line with the provisions of Implementing Regulation Annex III, B.5.4. requirements for laboratory analyses<sup>115</sup> and using **the following formula:**

$$EF_{CKD} = \left( \frac{EF_{Cli}}{1+EF_{Cli}} \cdot d \right) / \left( 1 - \frac{EF_{Cli}}{1+EF_{Cli}} \cdot d \right) \quad (\text{Equation 28})$$

Where:

EF<sub>CKD</sub> ... Emission factor of partially calcined cement kiln dust [t CO<sub>2</sub>/t CKD];

EF<sub>Cli</sub> ... Installation-specific emission factor of clinker [t CO<sub>2</sub>/t clinker];

d ... Degree of CKD calcination (released CO<sub>2</sub> as percentage of total carbonate CO<sub>2</sub> in the raw mix).

### Method B - clinker output based

For this method, a sector-specific rule is given in the Implementing Regulation:

**Activity data** AD<sub>j</sub> for clinker production [t] over the reporting period may be determined by either:

- Direct weighing of clinker (if technically feasible); or
- Based on cement deliveries, by material balance using the following stock adjustment calculation:

$$Cli_{prod} = (Cem_{deliv} - Cem_{SV}) \cdot CCR - Cli_s + Cli_d - Cli_{SV} \quad (\text{Equation 27})$$

Where

Cli<sub>prod</sub> is the amount of clinker produced expressed in tonnes,

Cem<sub>deliv</sub> the amount of cement deliveries expressed in tonnes,

Cem<sub>SV</sub> the cement stock variations expressed in tonnes,

CCR the clinker to cement ratio (tonnes clinker per tonne cement),

Cli<sub>s</sub> the amount of clinker supplied expressed in tonnes,

Cli<sub>d</sub> the amount of clinker dispatched, and

Cli<sub>SV</sub> the amount of clinker stock variations expressed in tonnes.

The **standard emission factors** EF<sub>j</sub> a standard value of 0,525 t CO<sub>2</sub>/t clinker is applied, as a minimum requirement. Recommended improvement would be to perform analyses of the clinker to determine the EF.

For the **conversion factor** CF<sub>j</sub> It is allowed to always use the conservative assumption that CF<sub>j</sub> = 1 in order to reduce monitoring efforts.



<sup>115</sup> Guidance on requirements for laboratory analyses is given in section 6.5.1.4.

## Clinker to cement ratio (CCR)

In calculating the embedded emissions in cement goods, the majority of emissions result from cement clinker. Therefore, the CCR, which is the mass ratio of tonnes cement clinker consumed per tonne of cement produced (also known as the ‘clinker factor’), must be taken into account.

The CCR should be derived either:

- Separately for each of the different cement products, based on laboratory analyses in line with the provisions of Annex Section B.5.4; or
- By calculation, as ratio from the difference of cement deliveries and stock changes and all materials used as additives to the cement including by-pass dust and cement kiln dust.

The CCR is expressed as a percentage (%) value, which typically ranges from 80 up to 95 % for Portland cement. The CCR is particularly relevant for the calculation of relevant embedded emissions for blended or composite cements that are produced, where the clinker content can range widely for different types of composite cement<sup>116</sup> with the balance being made up of other constituents such as mineral additives,<sup>117</sup> with zero emissions.

### 7.1.1.3 Additional reporting parameters

The following Table 7-1 lists out the additional information that should be provided by you as an operator to importers, in your emissions data communication to them.

Table 7-1: Additional cement sector parameters requested in the CBAM report

Aggregated goods category	Reporting parameter
Calcined clay <sup>118</sup>	– Whether or not the clay is calcined.
Cement clinker	– None.
Cement	– Clinker content of cement. This is the: <ul style="list-style-type: none"><li>– Mass ratio of tonnes cement clinker consumed per produced tonne of cement (<b>clinker to cement ratio or CCR</b>);</li><li>– Is expressed as percentage.</li></ul>
Aluminous cement	– None.

<sup>116</sup> European standard EN 197-1 defines five main common cement types CEM I (Portland cement) to V (Composite cement) and 27 different product types, where the clinker content in blended and composite cements (CEM II to V) may range from 95% down to as low as 5-20%.

<sup>117</sup> Mineral additives (mainly gypsum) along with secondary mineral additives (blast furnace slag and fly ash) are excluded from consideration under the CBAM and therefore have zero embedded emissions.

<sup>118</sup> Note that clays falling under CN code 2507 00 80 that are not calcined, are assigned embedded emissions of zero. They are still to be reported, but no additional information from the producer of the clay needs to be obtained.

You need to ensure that you collect all the parameters necessary for your CBAM goods and communicate them to the importers of your goods. The importer will need to report the additional parameters when the goods are imported to the EU under the CBAM.

### 7.1.2 Example for splitting a cement installation into separate production processes

In defining the system boundary for a production process, you as an operator will need to decide what physical production units belong to the production process(es) and what inputs, outputs, and emissions are relevant. The approach for doing this is discussed in Section 6.3 above and an example of this is given as shown in the Table 7-2 below for the cement sector.

For a notional cement plant that both produces and exports cement clinker (CN 2523 10 00) and cement (CN 2523 29 00), the operator would need to go through the following steps to split the cement plant into separate production processes under the CBAM:

#### Step 1: List all goods, physical units, inputs, outputs and emissions to/from the installation.

In this first step, the operator uses the existing information available on their installation, such as lists of industrial equipment and plans, to identify the:

- Physical units carrying out the production processes at their installation, such as kilns, boilers, dryers, flue gas cleaning, ball mills, bagging plant.
- Process inputs required for making the goods e.g. raw materials, fuel, electricity.
- Outputs from the process e.g. goods produced, by-products, heat, waste gases.
- Emissions from the process.

These are then listed out in Table 7-2 following.

Table 7-2: Checklist for inputs, physical units, outputs and emissions for an example cement installation.

<b>Inputs</b>	<b>Physical units</b>	<b>Outputs</b>	<b>Relevant CBAM Emissions</b>
Kiln – fossil fuels <sup>119</sup> e.g. coal, HFO	Kiln system and associated equipment e.g. for raw meal preparation	Kiln – cement clinker <sup>122</sup>  Mill – cement goods, by type <sup>123</sup>	Kiln – direct emissions from combustion of fuels

<sup>119</sup> Fuels combusted to generate heat for the use in the process under consideration or elsewhere. Both the fuel quantity (and in particular its carbon content / emission factor) as well its energy content are relevant for attributing it to different production processes.

<sup>122</sup> Precursor or intermediate good or product: where the production process also includes a ‘finished’ good. The precursor product may also be an output from the installation; for example, if the operator exported both cement clinker and cement from the installation.

<sup>123</sup> Cement finished good – physical product output of the installation/production process monitored.

Inputs	Physical units	Outputs	Relevant CBAM Emissions
Kiln – alternative and waste fuels (to cement clinker kiln) e.g. high CV fraction of MSW <sup>120</sup>  Kiln – electricity consumed by clinker kiln and associated equipment  Mill – fossil fuels to cement dryer  Mill – electricity consumed by cement grinding plant and associated equipment  Kiln – raw materials <sup>121</sup> : Limestone, clays  Kiln – alternative raw materials: e.g. fly ash  Mill – cement clinker from kiln  Mill – additives used in cement manufacture	Mill – grinding equipment (including dryer) and associated plant e.g. for bagging cement  Other industrial equipment unrelated to cement production (to be excluded from system boundaries).  Heat exchanger for district heating  Flue gas cleaning equipment (for treating gaseous and dust emissions)	Kiln – other outputs <sup>124</sup> : e.g. cement kiln dust  District heating, (or cooling or electricity) <sup>125</sup>	Kiln – direct emissions from alternative and waste fuels  Kiln – indirect emissions from electricity consumed.  Kiln – direct process emissions from carbonates  Mill – indirect emissions from electricity consumed.

Step 2: Identify relevant production processes and production routes.

In this step, the operator identifies that the installation produces cement clinker and cement, each of which is an aggregated goods category listed in Table 1 of Section 2 of Annex II of the Implementing Regulation (and in section 5 of this guidance document).

<sup>120</sup> High calorific value fraction of municipal solid waste

<sup>121</sup> Raw materials are materials which participate in other chemical reactions or which are physically modified in the process for generating the product.

<sup>124</sup> Other products (by-products) and waste: only need to be monitored if relevant in terms of carbon content for the determination of the production process's emissions, and energy content for corroboration purposes.

<sup>125</sup> Measurable heat (or cooling or electricity, if fuels are used in their generation) exported from a CBAM installation or production process should be treated like a second product, i.e. a certain amount of emissions must be subtracted from the emissions of that production process.



Each aggregated goods category is defined as a single production process. The operator uses the Table 7-2 as a checklist for assigning the relevant inputs, outputs and emissions to each production processes. This is relatively simple in most cases, for example:

- Cement clinker production process:
  - Physical units: Cement kiln, including preheaters, pre-calciner, clinker cooler, and associated auxiliary equipment such as flue gas cleaning.
  - Inputs / sources streams: Fuels, electricity, raw materials and alternative raw materials for the process.
  - Outputs (goods): Cement clinker, kiln dust (re-introduced it into the clinker production process).
  - Other outputs: measurable heat exported to district heating network.
  - Emission sources: direct (combustion and process) and indirect emissions (electricity consumed) related to the kiln system.
- Cement production process:
  - Physical units: Grinding plant, direct fired dryer and associated auxiliary equipment e.g. cement bagging plant.
  - Inputs / source streams: Cement clinker, electricity, fuels for the dryer, additive materials used in making cement such as gypsum.
  - Outputs (goods): Cement.
  - Emission sources: direct (from cement dryer, if applicable) and indirect emissions (from electricity consumed) related to the grinding process.

Using a schematic helps to visualise the respective system boundaries of each production process and production route, and to assign inputs, outputs and emissions accordingly.

Figure 7-1: Schematic used to define the system boundaries of an example cement clinker and cement processes

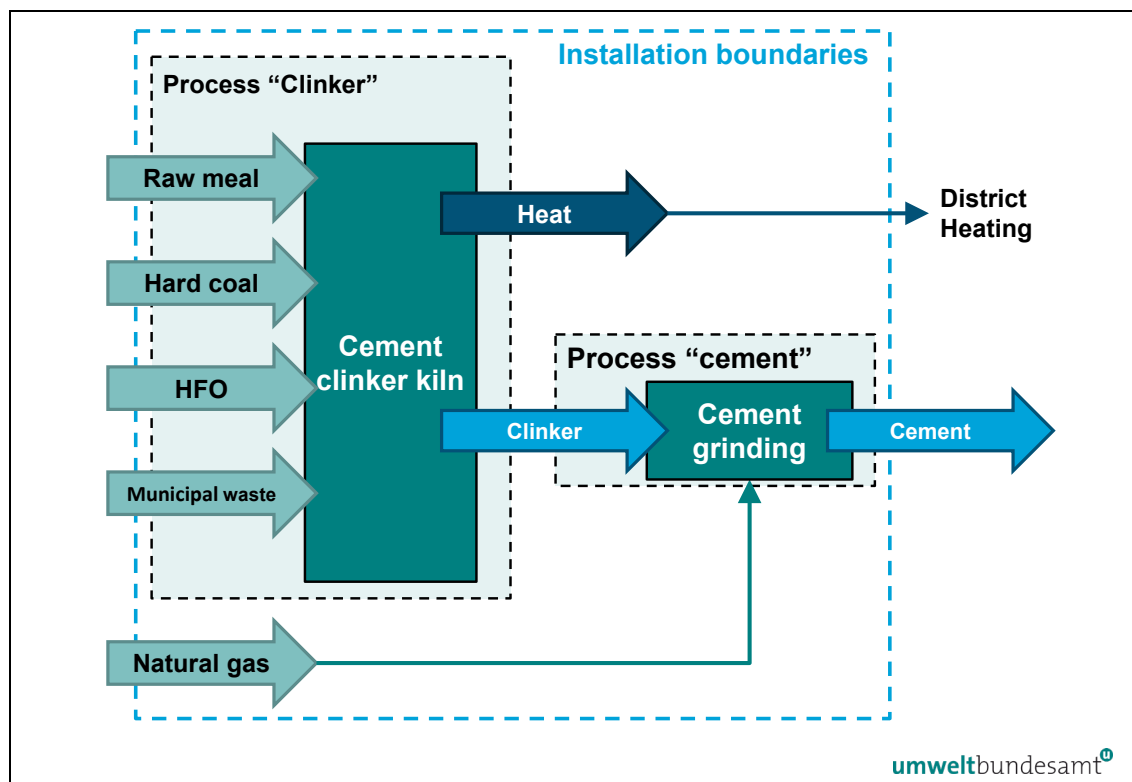

In the case of the above cement installation, both the kiln system and cement grinding plant are relatively self-contained parts of the installation, without shared equipment, and there is no doubt about the system boundaries of each production process. The only element that is not widely found in this industry is the heat recovery from the clinker kiln for the purpose of district heating. In practice it would not be a separate production process, but in calculating the attributed emissions of the clinker production process, the heat would be taken into account as shown in sections 6.2.2.2 and 6.7.2.

The following worked example for the cement sector shows how, for the production processes defined, relevant emissions are calculated and assigned to production processes, and specific embedded emissions are calculated. For simplification, the district heating is omitted in that example, as are the additional direct emissions from the dryer before the cement grinding.

### 7.1.3 Worked example for the cement sector

The following worked example shows how specific embedded emissions are derived for cement sector goods. The resulting embedded emissions of imports into the EU are then calculated at the end of the example for reporting in the transitional period.

In this example the installation produces two products, cement clinker and cement, each of which is defined as a single production process, as each is a separate category of CBAM aggregated good.

Figure 7-2 gives an outline view of the installation and shows the system boundaries as a hatched line for each production process. The physical units carrying out each production process have been grouped under ‘Clinker production’ and ‘Cement mill’ and the different inputs and outputs and sources of emissions have been identified for each production process.

Figure 7-2: Cement example – Overview

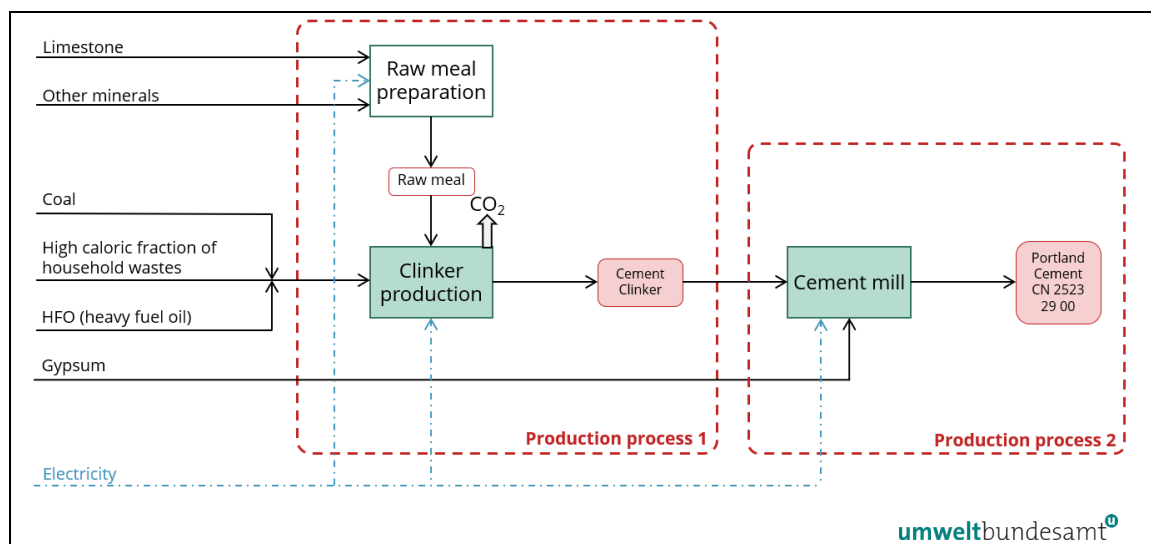

The two relevant production processes defined above are:

- Production process 1 – cement clinker produced in a cement kiln. The system boundaries of this production process have been defined as including inputs of raw materials (limestone and other minerals), fuels (coal, heavy fuel oil (HFO) and fractions of household waste) and electrical energy. Output from the process is cement clinker that is a relevant precursor for production process 2.
- Production process 2 – cement produced in a cement mill. The system boundaries of this production process have been defined as including the inputs gypsum (which as a raw material has no embedded emissions, precursor cement clinker (which has embedded emissions) and electrical energy. Output from the process is cement.

In this case, as all the output from production process 1 of precursor cement clinker goes directly into production process 2, it is possible to define a joint production process, or ‘bubble’, whereby the system boundaries of the production processes are combined, as shown in Figure 7-3.

Figure 7-3: Cement example – joint production process (‘bubble approach’) and complete monitoring approach – all red elements need to be monitored.

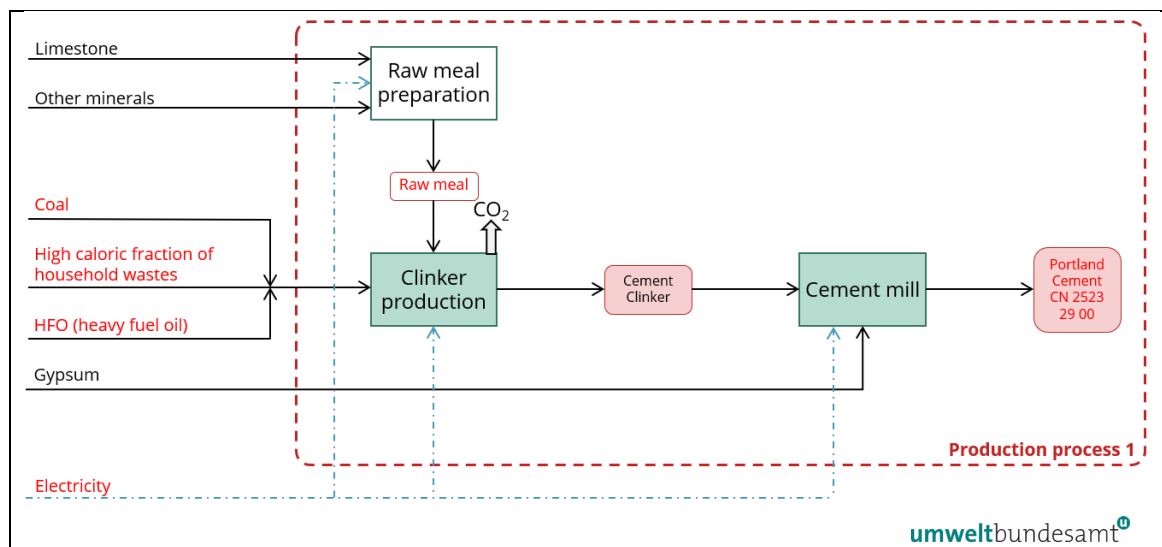

The system boundary has been redrawn to encompass both production processes previously defined for each CBAM aggregated good.

The inputs and outputs highlighted in red text above are the parameters that would need to be monitored by the operator in order to attribute emissions and determine direct and indirect specific embedded emissions for both production processes.

The direct and indirect emissions that are monitored in this example result from:

- Direct emissions from fuel combustion – fossil fuels (coal and HFO) and from a mixed fossil/biomass fuel derived from household waste (an alternative fuel).
- Direct emissions from the process – resulting from the thermal decomposition of carbonates in the raw meal input (produced from limestone and other minerals) to the cement kiln system.
- Indirect emissions from the electrical energy consumed by the joint production process.

The activity level of cement also needs to be monitored. As can be seen, the monitoring becomes significantly simpler with this ‘bubble approach’. In particular, the clinker amount and the associated embedded emissions do not have to be monitored separately, and there is no need to split quantities of electrical energy consumed according to the two processes.

The following tables summarise the fuel, electrical energy and raw material inputs monitored for determining specific embedded emissions (SEE). The calculation of the SEE values is carried out in two steps:

- Step 1 – derives SEE values for relevant precursor cement clinker; and

- Step 2 – derives SEE values for cement, taking into account i) embedded emissions of the precursor, and ii) the clinker to cement ratio (CCR), as well as any additional emissions occurring during the process.

Note that if any cement clinker produced by the installation were to be diverted and separately sold, the embedded emissions calculated under step 1 would also need to be communicated by the operator to the purchaser of the cement clinker goods. In that case the ‘bubble approach’ would not be allowed.

Table 7-3: Calculation of direct and indirect emissions, and SEE values for cement clinker

Direct emissions	AD (t)	NCV (GJ/t)	EF (t CO <sub>2</sub> /t or t CO <sub>2</sub> /TJ)	Biomass %	Emissions fossil (t CO <sub>2</sub> )	Emissions biomass (t CO <sub>2</sub> )
<b>Process emissions</b>						
Raw meal (standard factor) <sup>126</sup>	1 255 000		0,525		658 875	
<b>Combustion emissions</b>						
Coal	88 000	25	95		209 000	0
High NCV household waste <sup>127</sup>	25 000	20	83	15%	35 275	6 225
HFO	43 000	40	78		134 160	0
<b>Total direct emissions</b>					<b>1 037 310</b>	
<b>Indirect emissions</b>	<b>AD (MWh)</b>		<b>EF (t CO<sub>2</sub> / MWh)</b>		<b>Emissions (t CO<sub>2</sub>)</b>	
Electricity consumed	81 575		0,833		67 953	
<b>Clinker production (tonnes)</b>	1 255 000					
<b>Step 1: Specific embedded emission (SEE) values are derived using direct and indirect emissions and activity data for cement clinker.</b>						
<b>Cement clinker</b>	<b>Direct</b>	<b>Indirect</b>				
<b>SEE</b>	<b>0,8265</b>	<b>0,0541</b>	<b>t CO<sub>2</sub> / t</b>			

In the Table 7-3 above, step 1 is to calculate and attribute direct and indirect emissions associated with the production of cement clinker in the reporting period and derive SEE values for the amount of clinker produced.

Note that the emission factor used for raw meal above is a standard emission factor given in Implementing Regulation (EU) 2023/1773, Annex III, section B.9.2.2, which states that, as a minimum requirement to determine the emission factor, a standard value of 0,525 t CO<sub>2</sub>/t cement clinker is applied.

<sup>126</sup> Standard emission factor for cement clinker given in Implementing Regulation Annex III B.9.2.2., which states that as a minimum requirement to determine the emission factor, a standard value of 0,525 t CO<sub>2</sub>/t cement clinker is applied.

<sup>127</sup> Biomass being the biodegradable fraction in municipal waste. If the emission factor and/or NCV for municipal waste is not known, the standard values in Implementing Regulation Annex VIII Table 2 should be used, which are 11,6 GJ/t and 100 t CO<sub>2</sub>/TJ.

Note also that the direct emissions associated with the biomass content of the household waste is calculated separately and is deducted from the total direct emissions. This is because the biodegradable fraction of municipal waste (given as 15%, above) is treated as biomass and is effectively zero-rated for total emissions, as the RED II sustainability criteria do not apply to household / municipal waste.

Table 7-4: Calculation of total direct and indirect SEE values for cement final product (Step 2)

Portland cement production			Comment
tonnes clinker / tonne cement ratio	0,95		This is the CCR for Portland cement. The CCR is specific to the cement product produced.
	<b>MWh/t</b>	<b>t CO<sub>2</sub>/t</b>	
<b>Additional electricity consumption</b>	0,85	0,0708	For the cement grinding production process. Calculated as MWh/t x EF for electricity.
<b>Step 2: SEE values are derived for final cement product including the embedded emissions from the relevant precursor cement clinker</b>			
<b>Cement</b>	<b>SEE Direct</b>	<b>SEE Indirect</b>	
	t CO <sub>2</sub> / t cement	t CO <sub>2</sub> / t cement	
<b>Contribution of precursor (clinker)</b>	0,7852	0,0514	Calculated using the CRR, for example for SEE direct as 0,8265 t CO <sub>2</sub> / t x 0,95 = 0,7852 t CO <sub>2</sub> / t
<b>Production process</b>		0,0708	As above
<b>Total specific embedded emissions</b>	<b>0,7852</b>	<b>0,1222</b>	Sum of SEEs

The total embedded emissions to be reported by the authorised declarant (EU importer) for the import of Portland cement into the EU during the transitional period may then be determined, for example, for the import of 100 tonnes of Portland cement:

- **Transitional period (report only):**
  - Direct embedded emissions = 100 t x 0,7852 t CO<sub>2</sub> / t = 78,52 t CO<sub>2</sub>
  - Indirect embedded emissions = 100 t x 0,1222 t CO<sub>2</sub> / t = 12,22 t CO<sub>2</sub>

**Total: 90,74 t CO<sub>2</sub>**

## 7.2 Iron and Steel sector

The textbox below signposts sector-specific sections in the Implementing Regulation, relevant for the CBAM transitional period.

---

### Implementing Regulation references:

- **Annex II, Section 3 – Special provisions and emissions monitoring requirements by production route. Sub-sections 3.11 to 3.16 (iron and steel sector aggregated goods categories)**
-

- 
- **Annex IV**, Section 2 – Sector specific parameters for CBAM goods that should be reported by producers of goods to importers, in the Emissions Data Communication.

**Annex VIII**, Sections 1 and 2 – Standard emission factors used in the monitoring of direct emissions at installation level, including: Table 1: fuel emission factors including waste gases, Table 3: process emissions from carbonates, Table 5: process emissions from other process materials used in the production of iron and steel.

---

### **7.2.1 Sector-specific requirements for monitoring and reporting**

Direct and indirect embedded emissions should be monitored in line with the methodology set out in the Implementing Regulation and outlined in section 6 of this guidance document.

#### **7.2.1.1 Emissions monitoring**

Relevant emissions that should be monitored and reported for the iron and steel sector are:

- Carbon dioxide emissions (direct) from the fuel combustion process including waste or off-gases such as blast furnace gas (BFG), from stationary units only (excludes emissions from any mobile machinery such as vehicles).
- Carbon dioxide emissions (direct) from the process, resulting from the reduction of iron and steel by reducing agents such as coke or natural gas, from the thermal decomposition of carbonate raw materials<sup>128</sup>, from the carbon content of scrap or alloys, graphite<sup>129</sup> or other carbon containing materials entering the process.
- Carbon dioxide emissions (direct) resulting from the production of measurable heating (e.g. steam) and cooling that is consumed within the system boundaries of the production process, regardless of the location of the production of the heat (i.e. from on-site generation or from imports from off-site).
- Carbon dioxide emissions (direct) resulting from emissions control (e.g. from carbonate raw materials such as soda ash used for acidic flue gas cleaning). This is included for any good where this is applicable.

Direct emissions from the different source streams above are not reported separately but are added together to result in the total direct emissions for the installation or production process.

In deriving total direct emissions, carbon remaining in aggregated iron and steel goods such as pig iron, DRI, crude steel or iron alloys, or in slags or wastes, is also taken into account by using a mass balance method.

---

<sup>128</sup> Such as limestone, dolomite and carbonatic iron ores, including FeCO<sub>3</sub>,

<sup>129</sup> Such as graphite blocks used inside the blast furnace, or electrodes or electrode pastes

Indirect emissions from electricity consumed must be reported separately from direct emissions. Note that for this sector indirect emissions are only reported during the transitional period (and not during the definitive period).

### 7.2.1.2 Additional rules

#### Attribution of emissions

Given the complexity of production processes in the iron and steel sector, **during the transitional period** installations producing two or more goods from the groups sintered ore, pig iron, FeMn, FeCr, FeNi, DRI, crude steel, iron or steel products, may monitor and report embedded emissions defining **one joint production process**, or ‘**bubble**’, for all the products from these groups covered, if none of the precursors produced within the installation are sold separately.

Simplified!

### 7.2.1.3 Additional reporting parameters

The following Table 7-5 lists out the additional information that should be provided by you as an operator to importers, in your emissions data communication to them.

Table 7-5: Additional iron and steel sector parameters requested in the CBAM report

Aggregated good category	Reporting requirement
Sintered Ore	– None.
Pig Iron	– The main reducing agent used. – Mass % of Mn, Cr, Ni, total of other alloy elements.
FeMn Ferro-Manganese	– Mass % of Mn and carbon.
FeCr – Ferro-Chromium	– Mass % of Cr and carbon.
FeNi – Ferro-Nickel	– Mass % of Ni and carbon.
DRI (Direct Reduced Iron)	– The main reducing agent used. – Mass % of Mn, Cr, Ni, total of other alloy elements.
Crude steel	– The main reducing agent of the precursor, if known. – Content of alloys in steel – expressed as: – Mass % of Mn, Cr, Ni, total of other alloy elements. – Tonnes scrap used for producing one tonne crude steel. – % of scrap that is pre-consumer scrap.
Iron or steel products	– The main reducing agent used in precursor production, if known.



Aggregated good category	Reporting requirement
	<ul style="list-style-type: none"> <li data-bbox="563 226 1351 293">– Content of alloys in steel – expressed as:               <ul style="list-style-type: none"> <li data-bbox="603 293 1351 338">– Mass % of Mn, Cr, Ni, total of other alloy elements.</li> </ul> </li> <li data-bbox="563 360 1351 472">– Mass % of materials contained which are not iron or steel, if their mass is more than 1% to 5% of the total good’s mass.</li> <li data-bbox="563 495 1351 584">– Tonnes scrap used for producing one tonne of the product.</li> <li data-bbox="563 607 1351 651">– % of scrap that is pre-consumer scrap.</li> </ul>

You need to ensure that you collect all the parameters necessary for your CBAM goods and communicate them to the importers of your goods. The importer will need to report the additional parameters when the goods are imported to the EU under the CBAM.

## 7.2.2 *Worked examples for the iron and steel sectors*

### 7.2.2.1 *Example 1 – integrated steel works and conversion to iron or steel products.*

The following worked example shows how specific embedded emissions are derived for iron and steel sector goods, produced by the blast furnace/basic oxygen furnace (BOF) route. The resulting embedded emissions of imports into the EU are then calculated at the end of the example for reporting in the transitional period.

In this example for integrated steel making, the installation produces five products, each of which is defined as a single production process, as each is a separate category of CBAM aggregated good.

The diagram below gives an outline view of the installation and shows the system boundaries as a red (and blue) hatched line for each production process. The physical units carrying out each production process have been grouped under ‘Sinter plant’, ‘Blast furnace’, ‘LD converter’, and under forming as ‘Cold rolling, Hot rolling, Rail mill’ and ‘Power plant’; relevant inputs and outputs have been identified for each production process.

Figure 7-4: Example for carbon steel production, blast furnace route – Overview

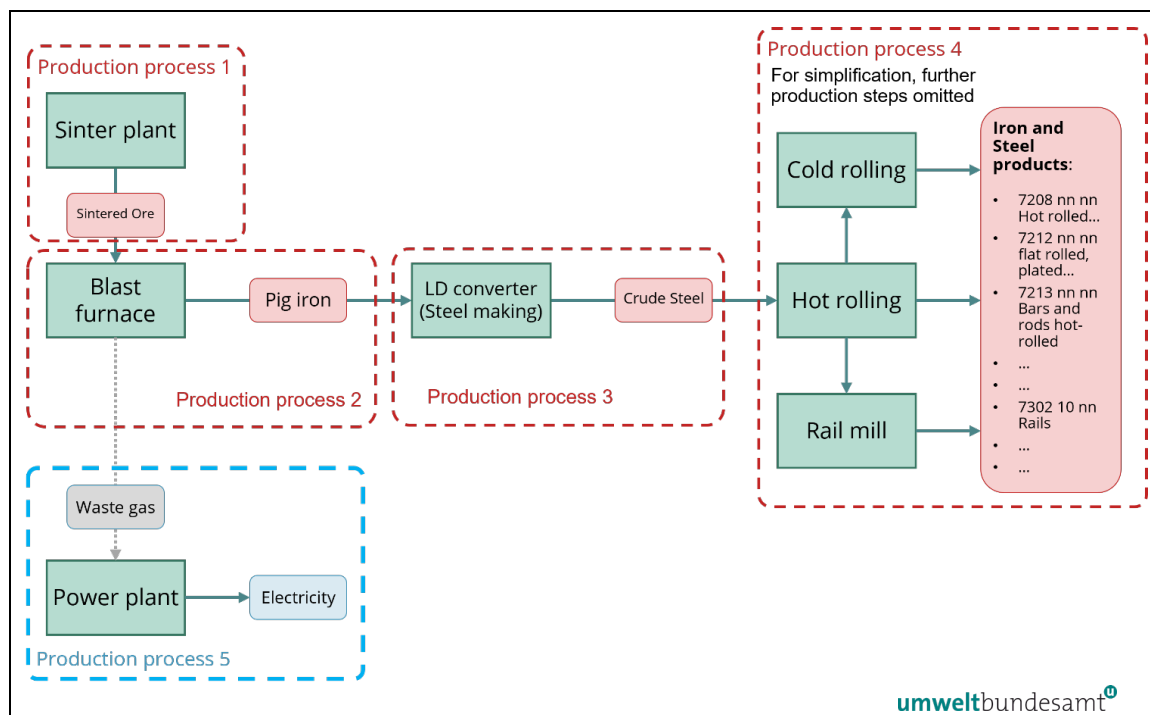

The five relevant production processes defined above, and elaborated further in the diagrams below are:

- Production process 1 – sinter (aggregated goods category ‘sintered ore’) produced in a sinter plant. The system boundaries of this production process have been defined as including inputs of raw materials (iron ore), fuels (coke fines) and electrical energy. The sintered ore output from the process is a relevant precursor for production process 2.
- Production process 2 – pig iron (hot metal) produced by a blast furnace. The system boundaries of this production process have been defined as including inputs of raw materials lime, coke (which have no embedded emissions), precursor sintered ore (which has embedded emissions), fuels/reducing agents including coke and plastics waste from households (i.e. a mixed waste fraction containing some biomass), as well as electrical energy. The pig iron output from the process is a relevant precursor for production process 3.
- Production process 3 – crude steel produced by the LD (basic oxygen) converter steelmaking route. The system boundaries of this production process have been defined as including inputs of raw materials lime and steel scrap (which have no embedded emissions), precursor pig iron (which has embedded emissions), fuels (natural gas) and electrical energy. The crude steel output from the process is a relevant precursor for production process 4.
- Production process 4 – iron or steel products produced by different forming processes (hot rolling, cold rolling and rail mill) to give basic products such as bars, rods, rails and other rolled products. The system boundaries of this production process have been defined as including inputs of crude steel (which has embedded emissions), fuels (natural gas) and electrical energy. Outputs from the production

process are all within the same aggregated goods category ‘iron or steel products’ (complex goods produced from the different precursors produced) that are sold.

- Production process 5 – electricity produced from waste gas from blast furnace (production process 2). Blast furnace gas is transferred from production process 2 to production process 5 and energy is recovered through the generation of electricity, for processes 1 to 4.

The second diagram (Figure 7-5) identifies the different source streams as inputs into the production processes, giving rise to direct emissions.

Figure 7-5: Example for carbon steel production, blast furnace route – Direct emissions and related source streams

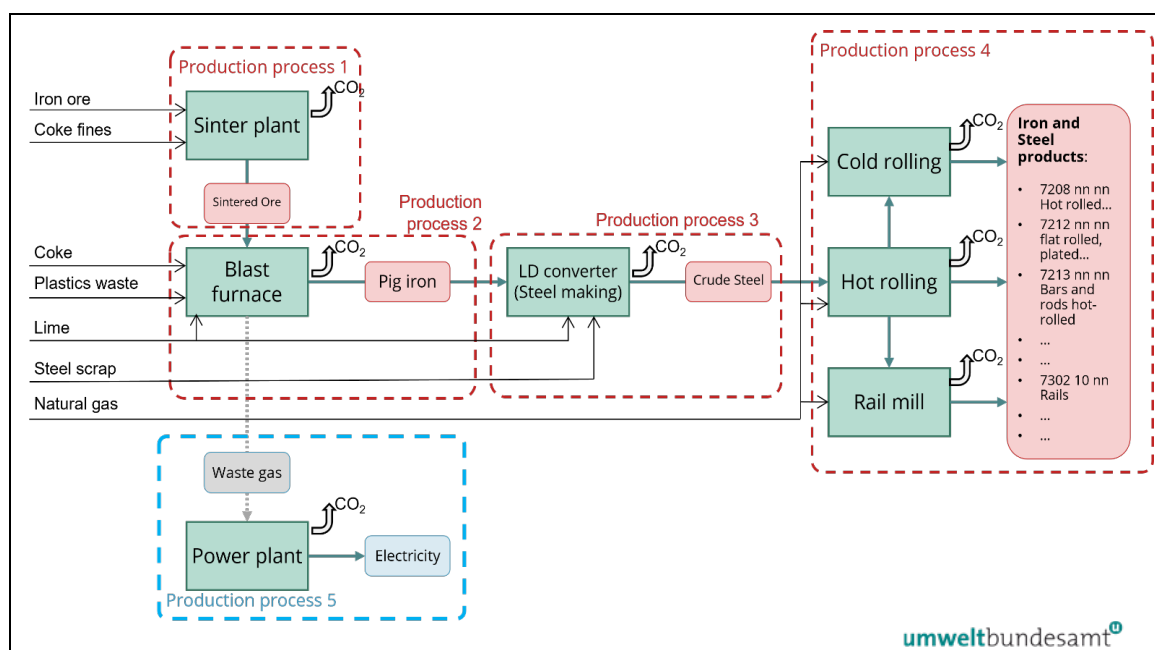

Direct emissions arise from the combustion of fuels (coke fines, plastic wastes, natural gas) and the waste gas (blast furnace gas) used for power generation, and from process emissions from coke<sup>130</sup> as reducing agent and the thermal decomposition of carbonate-containing materials (such as lime) and from releases of carbon contained within the different iron and steel materials.

The third diagram (Figure 7-6) below shows by the blue dashed line which electricity flows need to be monitored for indirect emissions, resulting from the consumption of electricity produced in the installation and purchased from the grid, consumed by production processes 1 to 4.

<sup>130</sup> Coke can also be treated as fuel, although it is primarily used as reducing agent. However, reporting it like a fuel, i.e. including its NCV, has the advantage that it can be included in an energy balance for consistency checking.

Figure 7-6: Example for carbon steel production, blast furnace route – Indirect emissions monitoring (electricity flows)

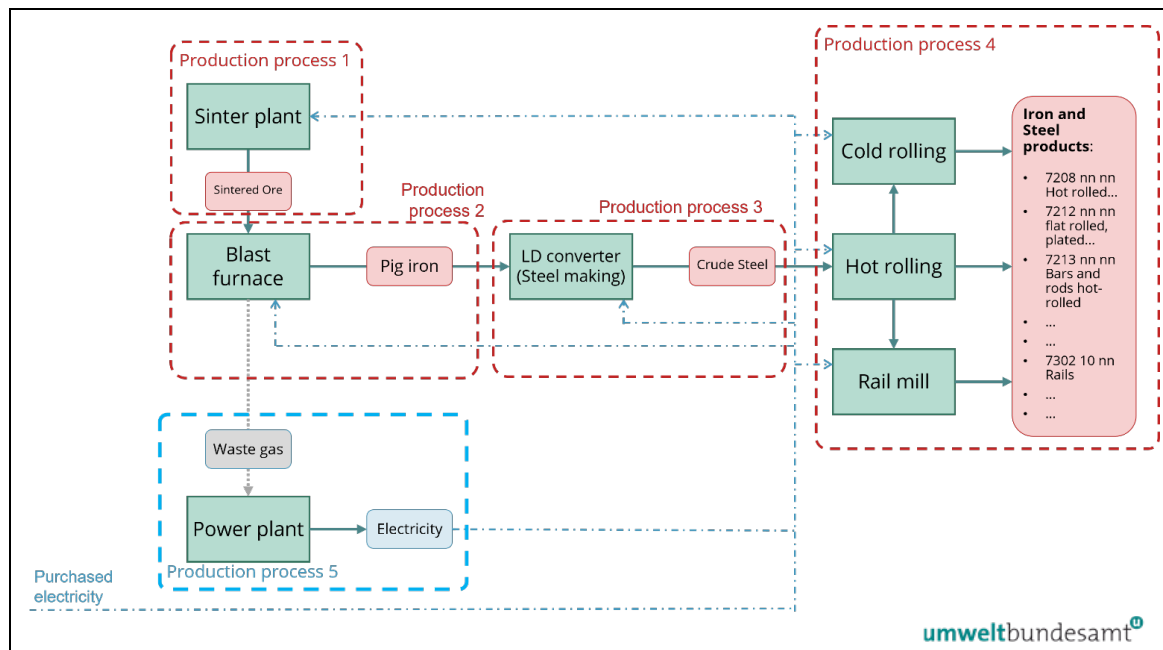

Some of the waste gas (blast furnace gas) that is produced by production process 2 is recovered as a fuel for generating electricity through production process 5. This electricity is used within the installation, thereby reducing the amount of imported grid electricity that is required. The assumption in this example is that the produced electricity is 100% consumed within the installation, but does not cover the complete electricity demand of the installation. Therefore, for indirect emissions calculation, a weighted average from the emission factor of the self-produced electricity and the grid electricity has to be calculated.

During the **transitional period**, given the **complexity** of production processes in the iron and steel sector, installations producing two or more of the sector's aggregated goods categories (i.e. sintered ore, pig iron, DRI, crude steel and iron or steel products) are permitted to monitor and report embedded emissions by defining one joint production process or '**bubble**', for all the iron and steel aggregated goods categories covered, provided that the precursors produced are wholly used to make the finished iron or steel products (see section 6.3).

Figure 7-7: Example for carbon steel production, blast furnace route – complete monitoring approach. All parameters in red font need to be monitored.

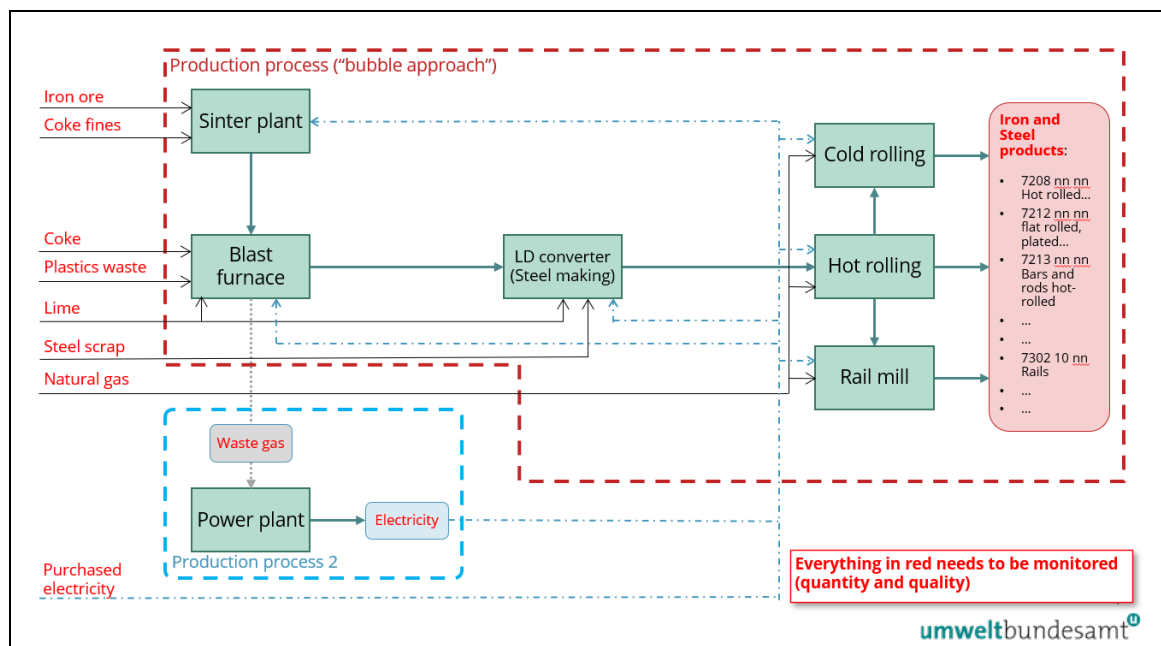

Figure 7-7 provides a complete monitoring approach for all source streams, for the example installation. In this figure a single bubbled system boundary has been drawn around production processes 1 to 4, for iron or steel products. Within the bubble, direct and indirect emissions for this production route result from:

- Fuel combustion – direct emissions from the combustion of fossil fuels and waste gases.
- Process emissions – direct emissions resulting from the thermal decomposition of carbonates, reductants (coke) and from the carbon content of iron and steel materials, including scrap.
- Indirect emissions from the electrical energy consumed by the joint production process is monitored and reported in the transitional period.

The inputs and outputs highlighted in red text are the parameters that would need to be monitored by the operator in order to attribute emissions and determine direct and indirect specific embedded emissions for the bubbled process. Monitoring encompasses both aspects, quantitative (activity data, see section 6.5.1.3) and qualitative (calculation factors, see section 6.5.1.4). The activity levels for the different goods produced would also need to be monitored. However, applying the bubble approach, interim products (precursors), in this example sintered ore, pig iron and crude steel, do not have to be monitored. Furthermore, quantities of electricity and fuels used in more than one of the production processes, do not have to be split by use levels in the production process.

Given the complexity of the installation with its different source streams and material flows, the mass balance method (see section 6.5.1.2) is used to give a complete balance of the amount of carbon entering and leaving the installation. In applying this method, the CO<sub>2</sub> quantities relevant for each source stream are calculated based on the carbon content (CC) in each material, without distinguishing fuels and process materials. Non-emitted

carbon leaving the installation in products and residues instead of being emitted is also taken into account, by defining output source streams, which have negative activity data, highlighted in red text in Table 7-6.

Table 7-6: Example calculation for carbon steel production, blast furnace route – Mass balance for the installation's direct emissions. AD = Activity data, CC = carbon content.

Consumption levels	AD (t)	CC	Bio fraction	Emissions (t CO <sub>2</sub> ) <sup>131</sup>	Comments
Coke fines	50 000	88,0%		161 216,0	
Iron ores	5 600 000	0,023%		4 719,2	
Coke	2 200 000	88,0%		7 093 504,0	
Plastic wastes	70 000	68,4%	16%	147 270,8	Biomass fraction <sup>132</sup> = 28 052 t CO <sub>2</sub>
Scrap (external)	800 000	0,210%		6 155,5	
Scrap (internal)	200 000	0,180%		1 319,0	
Lime calcined	280 000	0,273%		2 800,0	
Natural gas	170 000	75,0%		467 160,0	
Other inputs	40 000	10,0%		14 656,0	
<b>Sum</b>				<b>7 898 800,6</b>	
<b>Carbon in outputs</b>	<b>AD (t)</b>	<b>CC</b>		<b>“Emissions” (negative) (t CO<sub>2</sub>)</b>	
Steel	-4 800 000	0,180%		-31 657,0	
Slags	-1 000 000	0,030%		-1 099,0	
<b>Sum</b>				<b>-32 756,2</b>	
<b>Total direct emissions of the installation</b>				<b>7 866 044,4</b>	

In Table 7-6 above, the carbon content (CC) of the different input and output source streams is converted into its CO<sub>2</sub> equivalent, including for scrap from different sources. Emissions from biomass in the mixed plastic waste (assuming this is derived from MSW) is zero-rated for emissions (see section 6.5.4). Total direct emissions, net of carbon in outputs, is then calculated.

Total indirect emissions must then be calculated, along with a correction for waste gas from direct emissions that has been used to generate electricity. The following assumptions have been made for the purposes of this example.

<sup>131</sup> Factor 3,664 t CO<sub>2</sub> / t C

<sup>132</sup> Calculated above as 70 000 x 68,4% x 16% x 3,664 t CO<sub>2</sub> / t carbon = 28 052 t CO<sub>2</sub>

Table 7-7: Carbon steel, blast furnace route – Calculation of the installation's indirect emissions

<b>Installation's Indirect Emissions</b>
<p>Assumptions:</p> <ul style="list-style-type: none"> <li>– 40% of produced waste gas used for electricity production (35% efficiency).</li> <li>– This covers 75% of electricity consumption, the rest comes from the grid.</li> <li>– Emission factor for waste gas is based on equivalent natural gas, but lower efficiency than in other natural gas power plants (EF = 0,576 t CO<sub>2</sub> /MWh).</li> <li>– Grid emission factor = 0,628 t CO<sub>2</sub> / MWh (Mix 50% coal, 30% natural gas, rest renewable).</li> </ul> <p>Weighted emissions factor of consumed electricity at installation: <b>0,589 t CO<sub>2</sub> / MWh.</b></p> <p>Total electricity consumption of installation: 1 658 844 MWh / year.</p> <p><b>Total indirect emissions of the installation: 977 059 t CO<sub>2</sub> / year.</b></p>

To avoid double counting of emissions from waste gas used to generate electricity, it is necessary to make a deduction from direct emissions. The activity data for waste gas is calculated from electricity generated, using the information on fuel input and generation efficiency given above, as follows:

- Electricity generated from waste gas: 1 244 133 MWh (measured)
- Total waste gas fuel input: 1 244 133 / 0,35 efficiency = 3 554 666 MWh
- Converted to TJ: 3 544 666 \* 0,0036 = 12 800 TJ

The amount to deduct from direct emissions for waste gas used to generate electricity is calculated in Table 7-8 below, using the equation given in section 6.2.2.2 for  $WG_{corr,exp}$ .

Table 7-8: Example calculation, carbon steel, blast furnace route – installations' total direct emissions corrected for waste gas deduction

				<b>t CO<sub>2</sub> / year</b>	<b>Comment</b>
<b>Total direct emissions of the installation</b>				7 866 044	From Table 7-6 above
	AD (TJ)	EF (Nat. Gas)	Corr. factor		
Deduction for Waste gases	-12 800	56,1	0,667	<b>- 478 959</b>	Deduction for waste gas used to generate electricity
<b>Total direct emissions of the production process for crude steel products</b>				<b>7 387 085</b>	<b>Revised total direct emissions</b>

Next, Table 7-9 gives example activity level data for goods produced in the example installation during the reporting period.

Table 7-9: Example activity levels for goods produced in the reporting period

Products	Activity Level (AL)	Units
<b>Precursors</b>		
Pig Iron	4 000 000	t / year
Crude steel	5 000 000	t / year
<b>Iron or steel products</b>		
Sheets	3 500 000	t / year
Bars	800 000	t / year
Rails	500 000	t / year
<b>Total goods produced</b>	<b>4 800 000</b>	<b>t / year</b>
Internal scrap	200 000	t / year

Using the total direct and indirect emissions data from Table 7-7 and Table 7-8, and production data from Table 7-9, direct and indirect specific embedded emissions are then calculated for iron or steel products, as follows (Table 7-10).

Table 7-10: Example calculation, specific embedded emissions SEE under the simplified / "bubble" approach for iron or steel products

Total amount of goods produced (steel products)	4 800 000	t / year
Total direct emissions of the production process for steel products	7 387 085	t CO <sub>2</sub> / year
Total indirect emissions of the installation	976 919	t CO <sub>2</sub> / year
Specific direct embedded emissions	1,539	t CO <sub>2</sub> / steel product
Specific indirect embedded emissions	0,204	t CO <sub>2</sub> / t steel product
<b>Specific total embedded emissions</b>	<b>1,743</b>	<b>t CO<sub>2</sub> / t steel product</b>

As a last step, the **CBAM reporting obligation** for these iron or steel products into the EU can then be determined. For example, for the import of 10 000 tonnes of iron or steel products e.g. rails:

- **Transitional period (report only):**
  - Direct embedded emissions = 10 000 t x 1,539 t CO<sub>2</sub> / t = 15 390 t CO<sub>2</sub>
  - Indirect embedded emissions = 10 000 t x 0,204 t CO<sub>2</sub> / t = 2 040 t CO<sub>2</sub>

**Total: 17 430t CO<sub>2</sub>**

#### 7.2.2.2 Example 2 – EAF and conversion to iron or steel products

The following example shows how specific embedded emissions are derived for crude steel and iron or steel products, produced by the EAF route. The resulting embedded emissions of imports into the EU are then calculated at the end of the example for reporting in the transitional period.



In this example for the EAF steel making route, the installation produces products falling under two aggregated goods categories, each of which is defined as a single production process.

Figure 7-8 gives an outline view of the installation and shows the system boundaries as a red hatched line for each production process. The physical units carrying out each production process have been grouped under ‘Steel making EAF & AOD’, and under forming as ‘Cutting and welding’, ‘hot rolling to sheets, to bars and annealing’; and relevant inputs and outputs have been identified for each production process.

Note that high-alloy steels are produced in this example. Therefore, not only CN codes, but different alloy grades define the different goods produced. For reporting under the CBAM, in the transitional period the monitoring rules assume that all different alloys within the same aggregated goods category over the whole reporting period are considered to have the same embedded emissions, i.e. a weighted average of alloy grades is used in order to keep monitoring rules reasonably simple. However, the alloy grade (the content of alloying elements Cr, Mn and Ni, as well as the carbon content) has to be reported as additional information upon import. Therefore, the importer will have to report each CN code/alloy grade pair separately.

Figure 7-8: Example installation producing high-alloy steel from EAF route – Overview

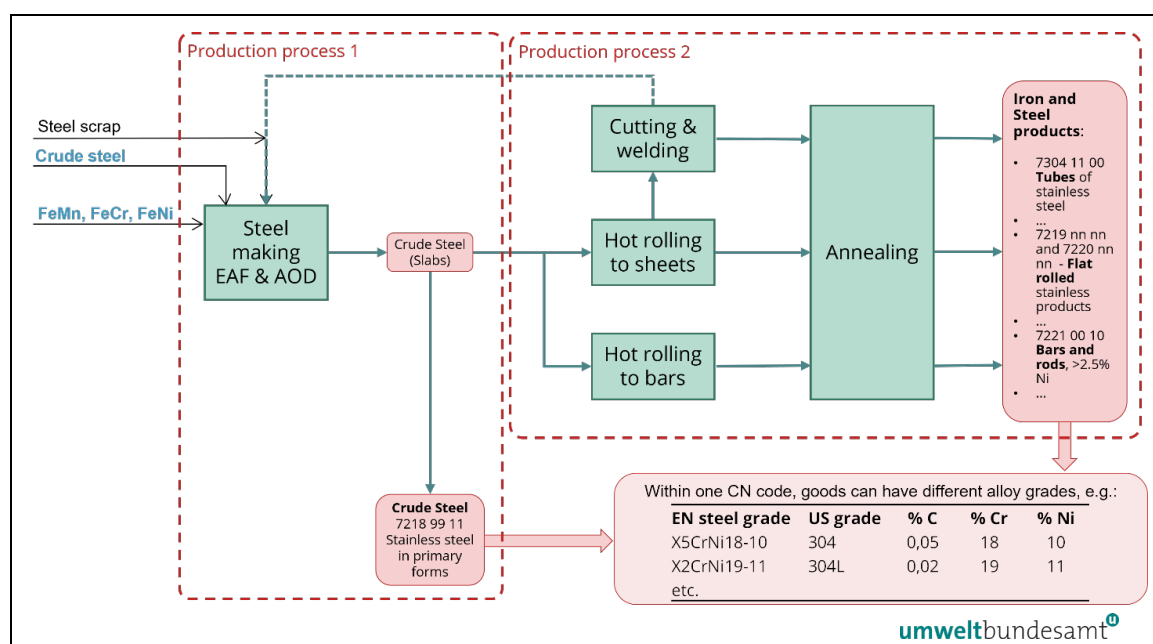

The two relevant production processes defined above, and elaborated further in the diagrams below are:

- Production process 1 – crude steel produced by the EAF/AOD steel making route as slabs, of different alloy grades. The system boundaries of this production process have been defined as including inputs of steel scrap from production process 2 (steel that is cut off during the production of pipes), precursors crude steel and alloys, fuels (natural gas), graphite electrodes and other additives and electrical energy. The crude steel output from the process is both sold and is a relevant precursor for production process 2. Due to the sale of precursor, the bubble approach is not allowed for this example installation.

- Production process 2 – iron or steel products, of different alloy grades, produced by different forming processes giving basic products such as tubes (cutting, rolling and welding), bars and rods (hot rolling and annealing) and sheets. The system boundaries of this production process have been defined as including inputs of crude steel (which has embedded emissions), fuels (natural gas) and electrical energy. Outputs from the production process are finished iron or steel products that are sold.

The second diagram (Figure 7-9) identifies the different source streams as inputs into the production processes, giving rise to direct emissions.

Figure 7-9: Example installation producing high-alloy steel from EAF route – source streams relevant for direct emissions monitoring with a calculation based approach

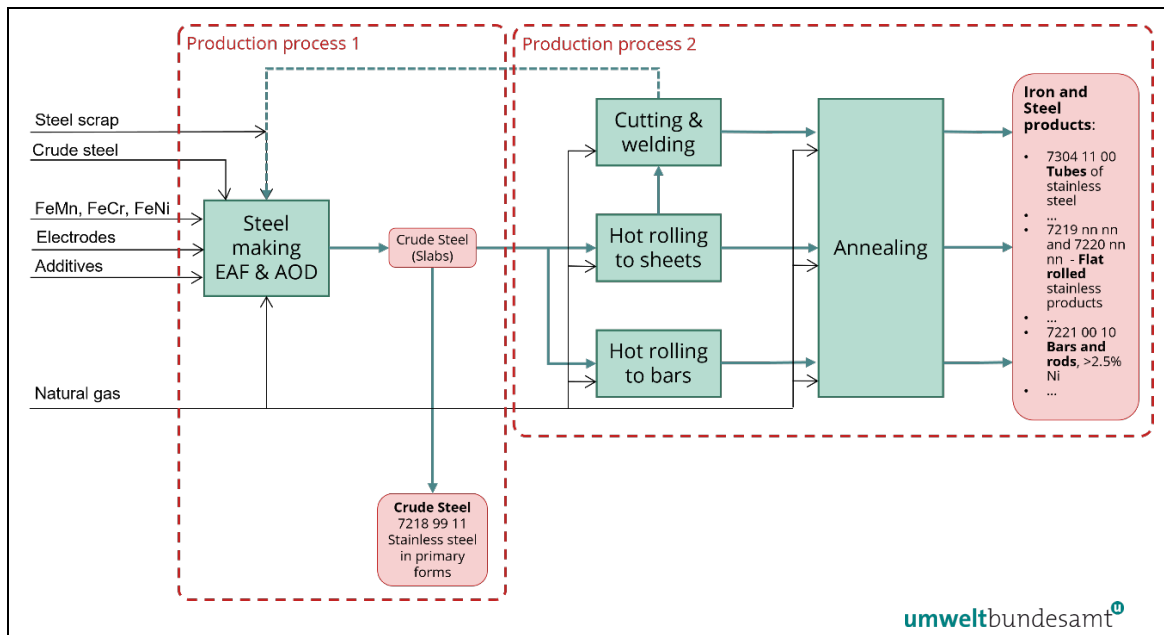

Direct emissions arise from the combustion of fuels (natural gas) and from process emissions from graphite electrodes, other additives and from releases of carbon contained within the different iron and steel materials.

The third diagram (Figure 7-10) shows indirect emissions resulting from the consumption of electricity consumed by production processes 1 and 2.

Figure 7-10: Example installation producing high-alloy steel from EAF route – Electricity consumption for indirect emissions monitoring.

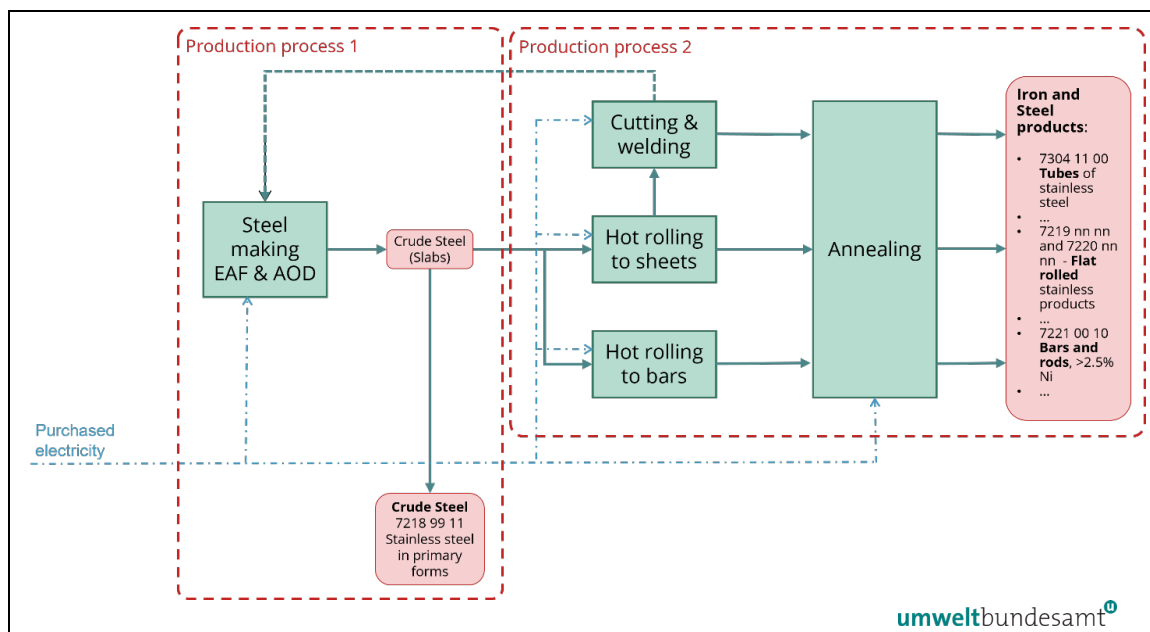

The fourth diagram (Figure 7-11), provides a complete monitoring approach for all source streams, for the example installation.

Figure 7-11: Example installation producing high-alloy steel via the EAF route – complete monitoring approach. All information in red font needs monitoring.

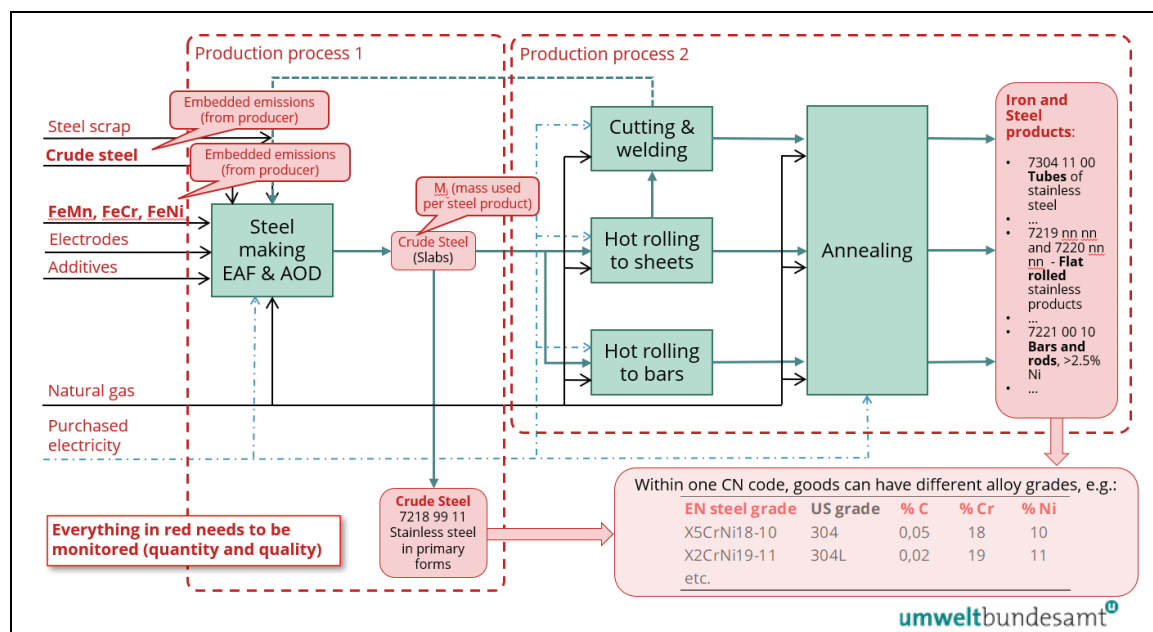

In iron and steel example 1 (section 7.2.2.1), a ‘bubble’ approach was used, as all precursors produced by the installation are wholly used in the production of the finished iron and steel goods. However, this approach is not available to the operator in this example, as some of the crude stainless-steel precursor produced by production process 1

is diverted and is sold before it reaches production process 2. Therefore, specific embedded emissions have to be separately derived for each production process at this installation.

The inputs and outputs highlighted in red text in Table 7-11 are the parameters that should be monitored by the operator in order to attribute emissions and determine direct and indirect specific embedded emissions for both processes. Monitoring encompasses both aspects, quantitative (activity data, see section 6.5.1.3) and qualitative (calculation factors, see section 6.5.1.4). In case of purchased precursors it includes the specific embedded emissions, see section 6.8.2).

Like in example 1, given the complexity of the installation and different source streams and material flows, the mass balance method is used to give a complete balance of the amount of carbon entering and leaving the installation. In applying this method, the CO<sub>2</sub> quantities relevant for each source stream are calculated based on the carbon content (CC) in each material, without distinguishing fuels and process materials. Non-emitted carbon leaving the installation in products instead of being emitted is also taken into account by defining output source streams, which have negative activity data, highlighted in red text in Table 7-11.

Table 7-11: EAF installation, example consumption levels – mass balance method

Consumption levels	AD (t)	CC	EF	NCV (GJ/t)	Emissions (tCO <sub>2</sub> ) <sup>133</sup>	Assumptions / comments
Steel scrap (market)	1 345 000	0,08%			3 942,5	Converted to CO <sub>2</sub>
Natural gas	163 806		56,1	48	441 096,9	IPCC values; EF as t CO <sub>2</sub> / TJ
Graphite electrodes	4 468	81,9%			13 407,6	IPCC values
Various additives	89 360		0,45		40 212,0	Limestone, others omitted; EF [tCO <sub>2</sub> /t]
Crude steel (purchased)	80 540	0,15%			442,6	
FeNi (28% Ni)	346 773	1,5%			19 058,6	
FeCr (52% Cr)	331 213	5,2%			63 105,4	
FeMn (31% Mn)	60 595	2,8%			6 216,6	
<b>Sum</b>					<b>587 482,3</b>	
<b>Carbon in outputs</b>	<b>AD</b>	<b>CC</b>			<b>Emissions (negative)</b>	
Steel	-2 140 000	0,180%			-14 114	Steel AL is net of scrap <sup>134</sup>
Slags	-107 232	0,030%			-118	
<b>Sum</b>					<b>-14 232</b>	
<b>Total direct emissions of the installation</b>					<b>573 251</b>	<b>t CO<sub>2</sub> / year</b>
<b>Indirect emissions</b>		MWh	EF (tCO <sub>2</sub> / MWh)		Emiss. t CO <sub>2</sub>	
Total electricity consumption		1 888 460	0,833		<b>1 573 087</b>	<b>t CO<sub>2</sub> / year</b>

<sup>133</sup> Factor 3,664 t CO<sub>2</sub> / t carbon

<sup>134</sup> i.e. after deduction of scrap amounts

In Table 7-11, the carbon content (CC) of different input and output source streams is converted to the CO<sub>2</sub> equivalent and total direct emissions, net of carbon contained in the outputs (steel and slag from the process) is calculated.

Total indirect emissions have also been calculated in the same table.

The next Table 7-12 summarises firstly the activity levels of the two production processes. Secondly, it shows how natural gas and electricity energy and emissions are attributed to processes 2. Energy and emissions data are calculated using the specific energy consumption (SEC) values for bars, sheets and pipes. The balance of direct emissions are then attributed to production process 1, in the lower part of the table.

Table 7-12: EAF installation, example calculation of embedded emissions by production process and product (Note: SEC = Specific energy consumption)

Production levels	Tonnes	EAF/AOD and (Hot) rolling energy consumption		Comment
		Natural gas GJ / t	Electricity kWh / t	
<b>Slabs</b>	2 234 000	0,31	700	<b>Process 1</b> – tonnes produced, EAF
Slabs to market	1 007 000			
<b>Bars to market</b>	456 000	5,4	180	<b>Process 2</b> – SEC values used to attribute energy and emissions.
<b>Sheets</b>	771 000	4,45	220	<b>Process 2</b> – SEC values used to attribute energy and emissions.
Sheets to market	221 000			
Sheets to pipes	550 000			
<b>Pipes</b>	456 000	2,8	160	<b>Process 2</b> – SEC values used to attribute energy and emissions.
Scrap (internal recycling)	94 000			Scrap from sheet to pipe conversion (cut-off steel).
<b>Split of emissions</b>		<b>Direct Emissions (t CO<sub>2</sub>)</b>	<b>Elec. consumed (MWh)</b>	<b>Indirect Emissions (t CO<sub>2</sub>)</b>
Process 1 (EAF / AOD)		171 005	1 563 800	1 302 645
Process 2 (rolling etc.)		402 245	324 660	270 442
<b>Total</b>		<b>573 251</b>	<b>1 888 460</b>	<b>1 573 087</b>

No embedded emissions are attributed to steel scrap from production process 2, which is recycled internally to process 1.

Using the data on the allocation of attributed emissions between the two production processes, in Table 7-12, specific embedded emissions are then calculated for each CBAM product in the following two tables, for both direct and indirect emissions. At this stage, the embedded emissions of precursors (purchased steel and alloys in process 1, crude steel in process 2) have to be added.

Table 7-13 calculates direct and indirect specific embedded emissions for crude steel slabs. Data used in these calculations are:

- Emissions at the installation for process 1 – determined above.

- Embedded emissions of precursors consumed by process 1 - calculated below, for precursors crude steel and alloys purchased.
- The Activity Level for crude steel slabs in the reporting period. The activity level is the sum of sold slabs and slabs used in process 2.

Table 7-13: EAF installation, example calculation of total embedded emission – Process 1 (Crude steel / slabs)

Precursors	SEE dir	MWh / t	SEE indir	Consumption (t)	direct em. (t CO <sub>2</sub> )	MWh	indirect (t CO <sub>2</sub> )	Total t CO <sub>2</sub>
Crude steel	1,48	0,245	0,204	80 540	119 199	19 724	16 430	
FeNi (28% Ni)	3,00	3,001	2,5	346 773	1 040 319	1 040 735	866 933	
FeCr (52% Cr)	2,5	2,821	2,35	331 213	828 034	934 396	778 352	
FeMn (31% Mn)	1,3	2,281	1,9	60 595	78 774	138 212	115 131	
<b>Calculation of Total Embedded Emissions of Slabs (process 1)</b>								
Activity Level for process 1 (slabs)				2 234 000				
Emissions at installation					171 005	1 563 800	1 302 645	
Embedded emissions of precursors consumed (from totals above)					2 066 325	2 133 067	1 776 845	
Total embedded emissions					2 237 331	3 696 867	3 079 490	5 316 821
<b>Specific embedded emissions (t CO<sub>2</sub> / t slab) or MWh / t</b>					<b>1,001</b>	<b>1,655</b>	<b>1,378</b>	<b>2,380</b>

The calculation for process 2 could be done in a similar way as for process 1. However, for the sake of guidance, Table 7-14 presents the calculation of direct and indirect specific embedded emissions for complex goods (iron or steel products) by way of using only specific embedded emissions and specific attributed emissions of the 2<sup>nd</sup> process, i.e. by omitting the activity level and total emissions of the 2<sup>nd</sup> production process.

Table 7-14: EAF installation, example calculation of embedded emissions of complex goods. Process 2 – steel products

<b>Total tonnes produced:</b>					
Bars to market	456 000	t			
Sheets to market	221 000	t			
Pipes	456 000	t			
<b>Total steel products</b>	<b>1 133 000</b>	t			
<b>Consumption precursor (slabs)</b>	<b>1 227 000</b>	t			
<b>Mass slabs (crude steel) consumed per t:</b>	<b>1,083</b>	t / t			
			<b>Direct (t CO<sub>2</sub>)</b>	<b>MWh</b>	<b>Indirect (t CO<sub>2</sub>)</b>
Mass ratio (M <sub>i</sub> ) precursor	1,083				
SEE <sub>i</sub> of precursor			1,001	1,655	1,378
Emissions per tonne product process 2			0,355	0,287	0,239
<b>Specific embedded emissions SEE (t CO<sub>2</sub> / t steel product)</b>			<b>1,440</b>	<b>2,079</b>	<b>1,732</b>
					<b>3,171</b>

When calculating the total embedded emissions of final steel products in process 2 above, the **mass ratio** ( $M_i$ ) of the precursor is taken account (see section 6.2.2.3 for details of the calculation approach). This is the mass of crude steel slabs consumed per tonne of steel products produced, and is calculated as:

- Mass slabs / mass steel products:  $1\,227\,000 / 1\,133\,000 = \mathbf{1,083}$  (as above). The direct and indirect  $SEE_i$  values of the precursor are then adjusted by this ratio i.e.:
- For  $SEE_i$  direct (precursor):  $1,001 \times 1,083 = 1,084$ .

Total direct and indirect specific embedded emissions of the complex steel product are then calculated, as above.

Using the above approach, the CBAM reporting obligation for the import of crude steel slabs and other steel products into the EU during the transitional period may then be determined; for example, for the import of 100 tonnes of product e.g. steel pipe:

- **Transitional period (report only):**
    - Direct embedded emissions =  $100 \times 1,440 = 144 \text{ t CO}_2$
    - Indirect embedded emissions =  $100 \times 1,732 = 173,2 \text{ t CO}_2$
- Total:  $317,2 \text{ t CO}_2$

### 7.3 Fertilizers sector

The textbox below signposts sector-specific sections in the Implementing Regulation, relevant for the CBAM transitional period.

---

#### Implementing Regulation references:

- **Annex II**, Section 3 – Special provisions and emissions monitoring requirements by production route. Sub-sections 3.7 to 3.10 (fertilizer sector aggregated goods categories)
  - **Annex IV**, Section 2 – Sector specific parameters for CBAM goods that should be reported by producers of goods to importers, in the Emissions Data Communication.
  - **Annex III**: Section **B.6** Requirements for a measurement-based methodology for CO<sub>2</sub> and N<sub>2</sub>O. Section **B.8**. Requirements for CO<sub>2</sub> transfers between installations. Section **B.9.3** Additional rules for determining emissions from nitric acid production, covering: **B.9.3.1** General rules for measurement-of N<sub>2</sub>O emissions; **B.9.3.2** Determination of flue gas flow; **B.9.3.3** Oxygen concentrations.
-

### **7.3.1 Sector-specific requirements for monitoring and reporting**

Direct and indirect embedded emissions should be monitored in line with the methodology set out in the Implementing Regulation and outlined in section 6 of this guidance document.

#### **7.3.1.1 Emissions monitoring**

Relevant emissions that should be monitored and reported for the fertilizers sector are:

- Carbon dioxide emissions (direct) from the fuel combustion process, from stationary plant only (excludes emissions from any mobile plant such as vehicles).
- Carbon dioxide and nitrous oxide (N<sub>2</sub>O) emissions (direct) from the process, in particular:
  - N<sub>2</sub>O emissions from the catalytic oxidation of ammonia and/or from the NO<sub>x</sub>/N<sub>2</sub>O abatement units (but not from combustion); and
  - Under certain conditions CO<sub>2</sub> transferred from the production process for ammonia to other installations (see section 6.5.6.2).
- Carbon dioxide emissions (direct) resulting from the production of measurable heating (e.g. steam) and cooling that is consumed within the system boundaries of the production process, regardless of the location of the production of the heat (i.e. from on-site generation or from imports from off-site).
- Carbon dioxide emissions (direct) resulting from emissions control (e.g. from carbonate raw materials such as soda ash used for acidic flue gas cleaning). This is included for any good where this is applicable.

Direct emissions from the different source streams above are not reported separately but are added together to result in the total direct emissions for the installation or production process.

Indirect emissions from electricity consumed must be reported separately from direct emissions.

Note that other N<sub>2</sub>O emissions resulting from the combustion of fuels are excluded from the system boundaries.

#### **7.3.1.2 Additional rules**

##### **Attribution of emissions for mixed fertilizers**

For installations producing different grades of mixed fertilizer, emissions for direct and indirect emissions are attributed separately, from embedded emissions consumed by the production process as follows:

- Direct and indirect emissions:
  - Are calculated for the whole reporting period.



- Are attributed to each fertilizer grade on a pro-rata basis per tonne of final product produced.
- Determining embedded emissions:
  - Are calculated separately for each fertilizer grade, taking into account the relevant mass of each precursor used in the manufacture of each grade.
  - For each precursor, the embedded emissions are the average for that precursor over the reporting period.

However, given the complexity of production processes in the fertilizer sector, **during the transitional period** installations producing mixed fertilizers may simplify the monitoring of the respective production process by determining one uniform value of embedded emissions per tonne of nitrogen contained in the mixed fertilizers, irrespective of the chemical form of nitrogen (ammonium, nitrate or urea forms)<sup>135</sup>.

Simplified!

### **Measurable heat produced from exothermic chemical processes**

Where an installation consumes measurable heat produced/recovered from an exothermic chemical process other than combustion, such as in the production of ammonia or nitric acid, the amount of recovered heat consumed is determined separately from other measurable heat, and is assigned zero CO<sub>2</sub> emissions.

### **Production of electricity**

If electricity is produced within the production process, a correction to the attributed emissions has to be made (see section 6.2.2.2). Where the electricity stems from processes without combustion (e.g. expansion turbines in ammonia production), the emission factor of that electricity is considered zero.

### **Transfers of CO<sub>2</sub> between production processes**

Where CO<sub>2</sub> from ammonia production is captured and transferred to a geological CO<sub>2</sub> storage site, the related emissions could be deducted, provided the receiving installation carries out monitoring under the CBAM or an equivalent MRV system (see section 6.5.6.2). Subject to future changes in the legislative framework of the EU ETS, which is taken into account for CBAM purposes, also CO<sub>2</sub> used as a feedstock (process input) in the production of products where the CO<sub>2</sub> is permanently chemically bound, it may be accounted for as subtraction in the direct embedded emissions of ammonia. However, under current legislation, urea does not qualify as such product, as the CO<sub>2</sub> is assumed to be emitted during its use as fertilizer. Details are given in section 6.5.6.2.

### **Measurement-based approach for monitoring N<sub>2</sub>O emissions**

Where there are N<sub>2</sub>O emissions from the process (not from combustion) in the fertilizer sector, you, as an operator, must monitor these using a Continuous Emission Measurement System (CEMS) installed at a suitable measurement point<sup>136</sup>. Detailed guidance on the

<sup>135</sup> In mixed fertilizer production European fertilizer legislation requires the content of N (in its different forms, as ammonium (NH<sub>4</sub><sup>+</sup>) or nitrate (NO<sub>3</sub><sup>-</sup>), urea or other (organic) forms) to be clearly indicated on the packaging or in accompanying sales documentation in case of bulk deliveries. These content values may be used to determine embedded emissions of any mixed fertilizer.

<sup>136</sup> If there are multiple emissions points that cannot be monitored from a single location, emissions from these various points should be separately monitored and the results combined for reporting purposes.

Implementing Regulation’s requirements for CEMS is given in section 6.5.2 of this document. N<sub>2</sub>O emissions are only regarded relevant for monitoring in the production of nitric acid. However, where nitric acid or the resulting nitrates (mixed fertilizers) are used as precursor, the related N<sub>2</sub>O emissions for an integral part of the embedded emissions, which are expressed as t CO<sub>2</sub>e:

$$CO_{2(e)} [t] = N_2O_{annual}[t] \times GWP_{N_2O}$$

Where:

*N<sub>2</sub>O<sub>annual</sub>* ... total annual N<sub>2</sub>O emissions, calculated as in section 6.5.2.

*GWP<sub>N<sub>2</sub>O</sub>* ... Global Warming Potential of N<sub>2</sub>O (t CO<sub>2</sub>e / t N<sub>2</sub>O). Please see Annex VIII to the Implementing Regulation for relevant GWP values (given also in Annex E of this guidance document).

For determining the flow rate of the flue gas, the Implementing Regulation states that the mass balance method as mentioned in section 6.5.2 is preferred over flow measurements.

### 7.3.1.3 Additional reporting requirements

The following Table 7-15 lists out the additional information that should be provided by you as an operator to importers, in your emissions data communication to them.

Table 7-15: Additional fertilizer sector parameters requested in the CBAM report

<b>Aggregated category</b>	<b>good</b>	<b>Reporting requirement in the quarterly report</b>
Ammonia <sup>137</sup>	–	Concentration, if hydrous solution.
Nitric acid <sup>138</sup>	–	Concentration (mass %).
Urea	-	Purity (mass % urea contained, % N contained).
Mixed fertilizers <sup>139,140</sup>		Content of different forms of nitrogen in mixed fertilizer: <ul style="list-style-type: none"> <li>- Content of N as ammonium (NH<sub>4</sub><sup>+</sup>);</li> <li>- Content of N as nitrate (NO<sub>3</sub><sup>-</sup>);</li> <li>- Content of N as Urea;</li> </ul>

<sup>137</sup> Both hydrous and anhydrous ammonia shall be reported jointly as 100% ammonia.

<sup>138</sup> Amounts of nitric acid produced shall be monitored and reported as 100% nitric acid.

<sup>139</sup> The amounts of different nitrogen compounds contained in the final product should be recorded in accordance with Regulation (EU) 2019/1009 laying down rules on the making available on the market of EU fertilizing products.

<sup>140</sup> Regulation (EU) 2019/1009 of the European Parliament and of the Council laying down rules on the making available on the market of EU fertilizing products.  
See: <http://data.europa.eu/eli/reg/2019/1009/2023-03-16>

**Aggregated category**      **good**      **Reporting requirement in the quarterly report**

- Content of N in other (organic) forms.

You need to ensure that you collect all the parameters necessary for your CBAM goods and communicate them to the importers of your goods. The importer will need to report the additional parameters when the goods are imported to the EU under the CBAM.

**7.3.2 Worked example for the fertilizer sector**

The following worked example shows how specific embedded emissions are derived for a particular mixed fertilizer grade, NPK 15-15-15, produced by mixing and granulation.

The resulting embedded emissions of imports into the EU are then calculated at the end of the example for reporting in the transitional period.

Figure 7-12 gives an outline view of the installation and shows the system boundaries as a hatched line for the single production process. The physical units carrying out the production process have been grouped under ‘Granulation with Pipe reactor’ (including an assumed dryer using natural gas) and the inputs and outputs and sources of emissions have been identified.

*Figure 7-12: Fertilizer example – Overview and complete monitoring approach for the production of a mixed fertilizer grade.*

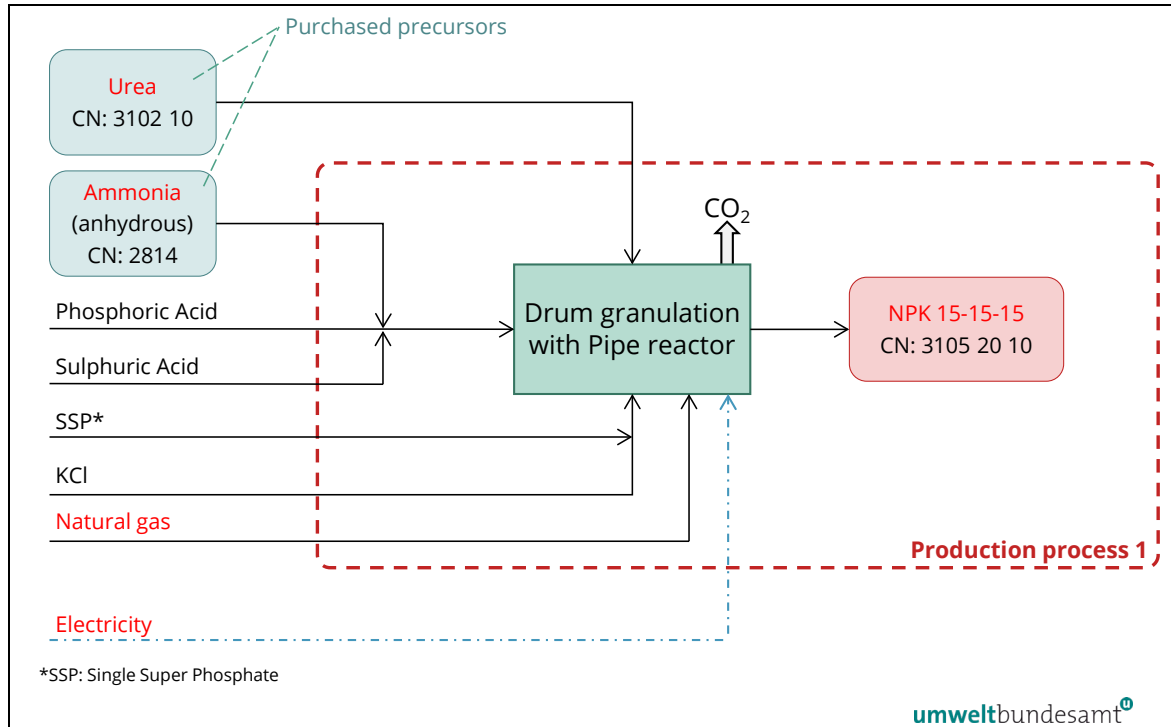

Inputs into the production process are raw materials, precursor goods urea and ammonia (anhydrous), and electrical energy. Outputs are mixed fertilizer product.

The inputs and outputs highlighted in red text above are the parameters that would need to be monitored by the operator in order to attribute emissions and determine direct and indirect specific embedded emissions for both production processes.

The direct and indirect emissions that are monitored in this example result from:

- Direct emissions from natural gas used in the dryer.
- Indirect emissions from the electrical energy consumed by the production process.

The inputs of precursors (with embedded emissions) and the activity level of the mixed fertilizer goods produced also need to be monitored.

Note that a single mixed fertilizer production process can make a wide range of different fertilizer grades (or formulations) using different quantities of precursor. Therefore, the specific embedded emissions for each fertilizer grade have to be determined separately from other grades that may also be produced at the same installation over the course of the same reporting period.

This is achieved by using:

- The relevant mass of each precursor used in each mixed fertilizer grade; and
- The specific embedded emissions of the precursors used to make a given mixed fertilizer grade.
- Assuming that the granulation and drying process is similar for all produced fertilizer grades, the direct and indirect emissions of the production process can be monitored over the full reporting period and then divided by the total activity level of the process, i.e. the total amount of all fertilizers produced in the reporting period. This gives a value of energy per tonne of fertilizer as used in the calculation in Table 7-16.

Table 7-16 sets out the process by which total direct and indirect specific embedded emissions for mixed fertilizer product NPK 15-15-15, are determined.

*Table 7-16: Example calculation of total direct and indirect specific embedded emissions for NPK mixed fertilizer.*

Inputs	Input mass (kg / t)	Precursor embedded emissions (t CO <sub>2</sub> /t)		Embedded emissions (t CO <sub>2</sub> /t)	
		direct	indirect	direct	indirect
KCl	251,3	n.a.	n.a.	n.a.	n.a.
SSP <sup>141</sup> 17% P <sub>2</sub> O <sub>5</sub>	200,0	n.a.	n.a.	n.a.	n.a.
Phosphoric acid (40% P <sub>2</sub> O <sub>5</sub> )	300,0	n.a.	n.a.	n.a.	n.a.
Sulphuric acid (96 wt-%)	116,0	n.a.	n.a.	n.a.	n.a.
NH <sub>3</sub>	93,0	1,900	0,208	0,177	0,019
Urea	160,0	0,719	0,178	0,115	<b>0,028</b>

<sup>141</sup> Single Super Phosphate

Energy needed for granulation (average of reporting period)				0,018	<b>0,006</b>
<b>Total SEE for mixed fertilizer product NPK 15-15-15</b>				0,310	<b>0,054</b>

Total direct and indirect specific embedded emissions for the mixed fertilizer product are calculated by combining the SEE values for relevant precursors and for energy needed for granulation, per tonne product, as above (see section 6.2.2.3 for details of the calculation approach).

Relevant precursor goods above are NH<sub>3</sub> and Urea. In order to determine the total embedded emissions of the mixed fertilizer product, the amount (kg) of each precursor used per tonne of mixed fertilizer product is taken into account, e.g. for urea the total input mass of precursor per tonne of product is 160 kg:

- Urea direct embedded emissions:  $0,160 \text{ t} / \text{t} \times 0,719 \text{ t CO}_2 / \text{t} = \mathbf{0,115 \text{ t CO}_2 / \text{t}}$  mixed fertilizer product.
- Urea indirect embedded emissions:  $0,160 \text{ t} / \text{t} \times 0,178 \text{ t CO}_2 / \text{t} = \mathbf{0,028 \text{ t CO}_2 / \text{t}}$  mixed fertilizer product.

Direct and indirect emissions arising from the mixing and granulation production process must also be included, as is done in Table 7-16 above per tonne of product. Other chemical raw material inputs (KCl, SSP, Phosphoric and Sulphuric acids) do not have embedded emissions and do not need to be taken into account.

Using the above approach, the CBAM reporting obligation due for the import of mixed fertilizer product into the EU during the transitional period may then be determined; for example, for the import of 100 tonnes of NPK 15-15-15 product:

- **Transitional period (report only):**
  - Direct embedded emissions =  $100 \text{ t} \times 0,310 \text{ t CO}_2 / \text{t} = 31 \text{ t CO}_2$
  - Indirect embedded emissions =  $100 \text{ t} \times 0,054 \text{ t CO}_2 / \text{t} = 5,4 \text{ t CO}_2$

**Total: 36,4 t CO<sub>2</sub>**

## 7.4 Aluminium sector

The textbox below signposts the sector-specific sections in the Implementing Regulation, relevant for the CBAM transitional period.

---

### Implementing Regulation references:

- **Annex II**, Section 3 – Special provisions and emissions monitoring requirements by production route. Sub-sections 3.17 to 3.18 (aluminium sector aggregated goods categories).
  - **Annex III**, Section A – Principles, sub-section A.4. Approach to dividing installations into production processes, sub-section (d);
-

- 
- **Annex III**, Section B – Monitoring of direct emissions at installation level, sub-section B.7. Requirements for determining perfluorocarbon emissions, covering: **B.7.1** Calculation method A – Slope Method; **B.7.2** Calculation method B – Overvoltage Method; **B.7.3** Rule for calculating CO<sub>2e</sub> emissions from PFC emissions using GWP values.
  - **Annex IV**, Section 2 – Sector specific parameters for CBAM goods that should be reported by producers of goods to importers, in the Emissions Data Communication.
  - **Annex VIII**, Section 3 – Table of GWP for perfluorocarbons.
- 

#### **7.4.1 Sector-specific requirements for monitoring and reporting**

Direct and indirect embedded emissions should be monitored in line with the methodology set out in the Implementing Regulation and outlined in section 6 of this guidance document.

##### **7.4.1.1 Emissions monitoring**

Relevant emissions that should be monitored and reported for the aluminium sector are:

- Carbon dioxide emissions (direct) resulting from the consumption of pre-baked carbon anodes or green anode paste during electrolysis – emissions result from the reaction of the carbon electrode with oxygen from the alumina or from other sources of oxygen such as from air<sup>142</sup>. There are also emissions associated with the self-baking (coking) of green anode paste in situ in the Söderberg process.
- Carbon dioxide emissions (direct) resulting from furnaces (e.g. holding, pre-heating, re-melting and annealing), where heated by the combustion of fuels used for the furnaces, from stationary plant only (excludes emissions from any mobile units such as vehicles).
- Carbon dioxide emissions (direct) resulting from the production of measurable heating (e.g. steam) and cooling, that is consumed within the system boundaries of the production process, regardless of the location of the production of the heating and cooling (i.e. from on-site generation or from imports from off-site).
- PFC emissions (direct) for CF<sub>4</sub> and C<sub>2</sub>F<sub>6</sub> only, formed during brief upset conditions known as the ‘Anode Effect’, when alumina levels drop too low and the electrolytic bath itself undergoes electrolysis.
- Carbon dioxide emissions (direct) resulting from emissions control (e.g. from carbonate raw materials such as soda ash used for acidic flue gas cleaning).

Note that emissions related to the production of pre-baked carbon anodes (even if produced on the same site) and alumina are excluded from the system boundary.

---

<sup>142</sup> All formed carbon monoxide (CO) is assumed to be converted to CO<sub>2</sub>.

Direct emissions from the different source streams above are not reported separately but are added together to result in the total direct emissions for the installation or production process.

Indirect emissions from electricity consumed must be reported separately from direct emissions. Note that for this sector indirect emissions are only reported during the transitional period (and not during the definitive period).

#### 7.4.1.2 Additional rules

##### Attribution of emissions

Given the complexity of production processes in the aluminium sector, **during the transitional period** installations producing two or more goods from the aggregated goods categories ‘unwrought aluminium’ or ‘aluminium products’, may be monitored and reported defining one joint production process for all the products from these groups covered, provided no intermediate product (i.e. precursor to one of the processes) is sold or otherwise transferred out of the installation.

Simplified!

##### Determining process emissions

Additional rules also apply for determining PFC emissions (CF<sub>4</sub> and C<sub>2</sub>F<sub>6</sub> only) from primary aluminium production. However, where primary aluminium is used as a precursor, the related PFC emissions form part of the embedded emissions of the final product.

Two different calculation-based methods are available in accordance with Implementing Regulation, Annex III, section B.7. Both methods are considered equivalent, but as each requires different data, you should choose the method that is most appropriate for your installation’s process control equipment:

- **‘Slope method’ (Method A)** – where the ‘anode effect minutes per cell-day’ (AEM) are recorded. The AEM expresses the frequency of anode effects (number of anode effects / cell-day) multiplied by the average duration of anode effects (anode effect minutes / occurrence).
- **‘Overvoltage method’ (Method B)** – where the ‘anode effect overvoltage’ (AEO) per cell [mV] is recorded. The AEO is determined as the integral of (time × voltage above the target voltage) divided by the time (duration) of data collection.

##### Calculation Method A – Slope Method

The following equations for determining PFC emissions shall be used under method A:

$$CF_4 \text{ emissions [t]} = AEM \times (SEF_{CF_4}/1\ 000) \times Pr_{Al}$$

$$C_2F_6 \text{ emissions [t]} = CF_4 \text{ emissions} \times F_{C_2F_6}$$

Where:

*AEM* is the anode effect minutes / cell-day;

$SEF_{CF_4}$  is the slope emission factor expressed in (kg CF<sub>4</sub> / t Al produced) / (anode effect minutes / cell-day)]. Where different cell-types are used, different  $SEF$  may be applied as appropriate;

$Pr_{Al}$  is the production of primary aluminium [t] during the reporting period, and

$F_{C_2F_6}$  is the weight fraction of C<sub>2</sub>F<sub>6</sub> [t C<sub>2</sub>F<sub>6</sub> / t CF<sub>4</sub>].

The anode effect minutes per cell-day expresses the frequency of anode effects (number anode effects / cell-day) multiplied by the average duration of anode effects (anode effect minutes / occurrence):

$$AEM = frequency \times average\ duration$$

Emission factor: The emission factor for CF<sub>4</sub> (slope emission factor,  $SEF_{CF_4}$ ) expresses the amount [kg] of CF<sub>4</sub> emitted per tonne of aluminium produced per anode effect minute per cell-day. The emission factor (weight fraction  $F_{C_2F_6}$ ) of C<sub>2</sub>F<sub>6</sub> expresses the amount [kg] of C<sub>2</sub>F<sub>6</sub> emitted proportionate to the amount [kg] of CF<sub>4</sub> emitted.

Table 7-17: Technology-specific emission factors related to activity data for the slope method.

Technology	Emission factor for CF <sub>4</sub> ( $SEF_{CF_4}$ ) [(kg CF <sub>4</sub> /t Al) / (AE-min/cell-day)]	Emission factor for C <sub>2</sub> F <sub>6</sub> ( $F_{C_2F_6}$ ) [t C <sub>2</sub> F <sub>6</sub> / t CF <sub>4</sub> ]
Legacy Point Feed Pre Bake (PFPB L)	0,122	0,097
Modern Point Feed Pre Bake (PFPB M)	0,104	0,057
Modern Point-Fed Prebake without fully automated anode effect intervention strategies for PFC emissions (PFPB MW)	– (*)	– (*)
Centre Worked Prebake (CWPB)	0,143	0,121
Side Worked Prebake (SWPB)	0,233	0,280
Vertical Stud Søderberg (VSS)	0,058	0,086
Horizontal Stud Søderberg (HSS)	0,165	0,077

(\*) The installation has to determine the factor by own measurements. If this is technically not feasible or involves unreasonable costs, the values for CWPB methodology shall be used.

### Calculation Method B – Overvoltage Method

For the overvoltage method, the following equations shall be used:

$$CF_4\ emissions\ [t] = OVC \times (AEO/CE) \times Pr_{Al} \times 0,001$$

$$C_2F_6\ emissions\ [t] = CF_4\ emissions \times F_{C_2F_6}$$

Where:

$OVC$  is the overvoltage coefficient (‘emission factor’) expressed in kg CF<sub>4</sub> per tonne of aluminium produced per mV overvoltage;



*AEO* is the anode effect overvoltage per cell [mV] determined as the integral of (time × voltage above the target voltage) divided by the time (duration) of data collection;

*CE* is the average current efficiency of aluminium production [%];

*Pr<sub>Al</sub>* is the annual production of primary aluminium [t], and

*F<sub>C2F6</sub>* is the weight fraction of C<sub>2</sub>F<sub>6</sub> [t C<sub>2</sub>F<sub>6</sub> / t CF<sub>4</sub>].

the term *AEO/CE* (Anode effect overvoltage / current efficiency) expresses the time-integrated average anode effect overvoltage [mV overvoltage] per average current efficiency [%].

Table 7-18: Technology-specific emission factors related to overvoltage activity data.

Technology	Emission factor for CF <sub>4</sub> [(kg CF <sub>4</sub> /t Al) / mV]	Emission factor for C <sub>2</sub> F <sub>6</sub> [t C <sub>2</sub> F <sub>6</sub> / t CF <sub>4</sub> ]
Centre Worked Prebake (CWPB)	1,16	0,121
Side Worked Prebake (SWPB)	3,65	0,252

- **Minimum requirement** for both methods: Technology-specific emission factors given in the Implementing Regulation, Annex III, section B.7 are used.
- **Recommended improvement:** Installation-specific emission factors for CF<sub>4</sub> and C<sub>2</sub>F<sub>6</sub> are established through continuous or intermittent field measurements at least every 3 years or after significant changes in the installation, taking into account industry best practice guidelines<sup>143</sup>.



### Calculating CO<sub>2</sub>(e) emissions from PFC emissions

The following formula may be used to calculate CO<sub>2</sub>(e) from CF<sub>4</sub> and C<sub>2</sub>F<sub>6</sub> emissions, using the global warming potential (GWP) for these gases:

$$\text{PFC emissions [t CO}_2\text{(e)]} = \text{CF}_4 \text{ emissions [t]} \times \text{GWP}_{\text{CF}_4} + \text{C}_2\text{F}_6 \text{ emissions [t]} \times \text{GWP}_{\text{C}_2\text{F}_6}$$

Please see Annex VIII to the Implementing Regulation for relevant GWP values (given also in Annex E of this guidance document).

Furthermore, fugitive emissions of PFC are taken into account calculated from the emissions measurable in a duct or stack ('point source emissions') using the collection efficiency of the duct:

$$\text{PFC emissions (total)} = \text{PFC emissions (duct)} / \text{collection efficiency}$$

The collection efficiency shall be measured when the installation-specific emission factors are determined.

<sup>143</sup> For example, the International Aluminium Institute best practice guidelines.

### 7.4.1.3 Additional reporting requirements

The following Table 7-19 lists out the additional information that should be provided by you as an operator to importers, in your emissions data communication to them.

Table 7-19: Additional aluminium sector parameters requested in the CBAM report

<b>Aggregated good category</b>	<b>Reporting requirement in the quarterly report</b>
Unwrought aluminium	<ul style="list-style-type: none"><li>– Tonnes of scrap used for producing one tonne of the unwrought aluminium product.</li><li>– % of scrap that is pre-consumer scrap.</li><li>– Content of alloys in aluminium: If the total content of elements other than aluminium exceeds 1%, the total percentage of such elements.</li></ul>
Aluminium products	<ul style="list-style-type: none"><li>– Tonnes of scrap used for producing one tonne of the unwrought aluminium product.</li><li>– % of scrap that is pre-consumer scrap.</li><li>– Content of alloys in aluminium: If the total content of elements other than aluminium exceeds 1%, the total percentage of such elements.</li></ul>

These parameters depend on the goods produced. Alloying elements play a minor role and are not reflected in the CN classification of aluminium goods. However, where the product contains **more than 5% alloying elements**, you should calculate the embedded emissions of the product as if the mass of alloying elements were **unwrought aluminium from primary smelting**.

You need to ensure that you collect all the parameters necessary for your CBAM goods and communicate them to the importers of your goods. The importer will need to report the additional parameters when the goods are imported to the EU under the CBAM.

### 7.4.2 Worked example for the aluminium sector

The following worked example shows how specific embedded emissions are derived for aluminium sector goods. The resulting embedded emissions of imports into the EU are then calculated at the end of the example for reporting in the transitional period. In this example the installation produces products from two aggregated goods categories, unwrought aluminium and aluminium products, each of which is defined as a single production process, as the intermediate product is sold. Therefore, a ‘bubble approach’ is not possible.

Figure 7-13 gives an outline view of the installation and shows the system boundaries as a hatched line for each production process. The physical units carrying out each production

process have been grouped under ‘Primary smelting’ and ‘Forming steps’ and the different inputs and outputs and sources of emissions have been identified for each production process.

Figure 7-13: Aluminium example – overview

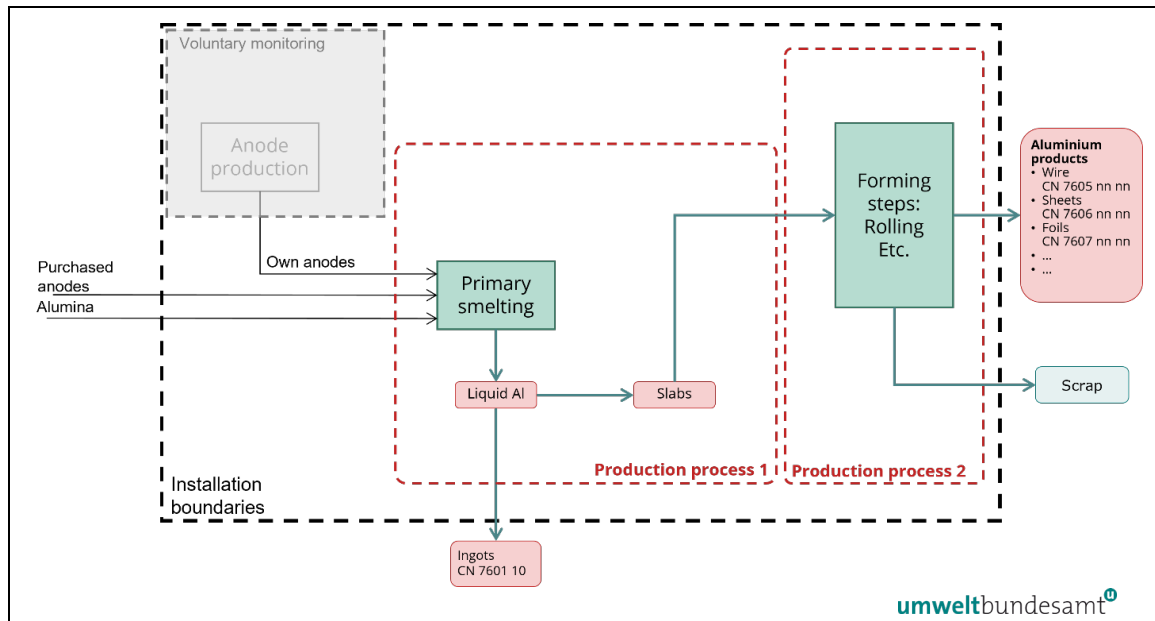

The two production processes defined above are:

- Production process 1 – primary smelting process route producing unwrought aluminium as ingots (which may be sold) and slabs, which are transferred to production process 2. Raw material inputs are anodes, both manufactured on site and purchased from elsewhere, and alumina.
- Production process 2 – different forming processes producing a range of aluminium products, such as wire, sheets and foils. Raw material inputs are unwrought aluminium slabs transferred from production process 1. There is also scrap from this process. This is sent off-site for recycling.

The second diagram (Figure 7-14) identifies sources of direct emissions from the installation.

Figure 7-14: Aluminium example – Identification of source streams for monitoring of direct emissions

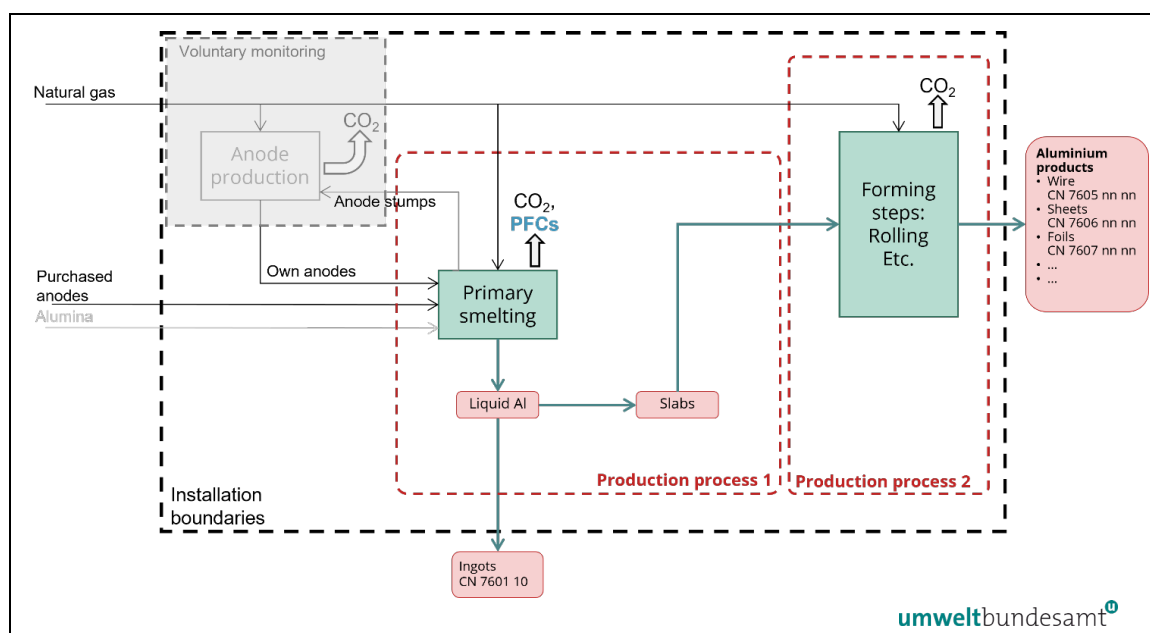

Direct emissions above result from fuel combustion in both production processes, and from the primary smelting process - from the consumption of carbon anodes and from the formation of PFCs.

Note that on-site anode production is ignored, as anodes are raw materials and are therefore considered to have zero embedded emissions. For monitoring the anode consumption, the difference of anode input and anode stumps recycled result in the activity data of anode consumption.

However, for completeness you may wish on a voluntary basis to fully monitor all sources of direct and indirect emissions, which in this case would include a full mass balance of raw materials and additional fuels consumed in the anode production. Alumina consumption does not need monitoring, as it neither contributes to the direct emissions nor to embedded emissions.

The third diagram (Figure 7-15) shows indirect emissions resulting from the consumption of electricity consumed by production processes 1 and 2.

Figure 7-15: Aluminium example - Indirect emissions monitoring (electricity consumption)

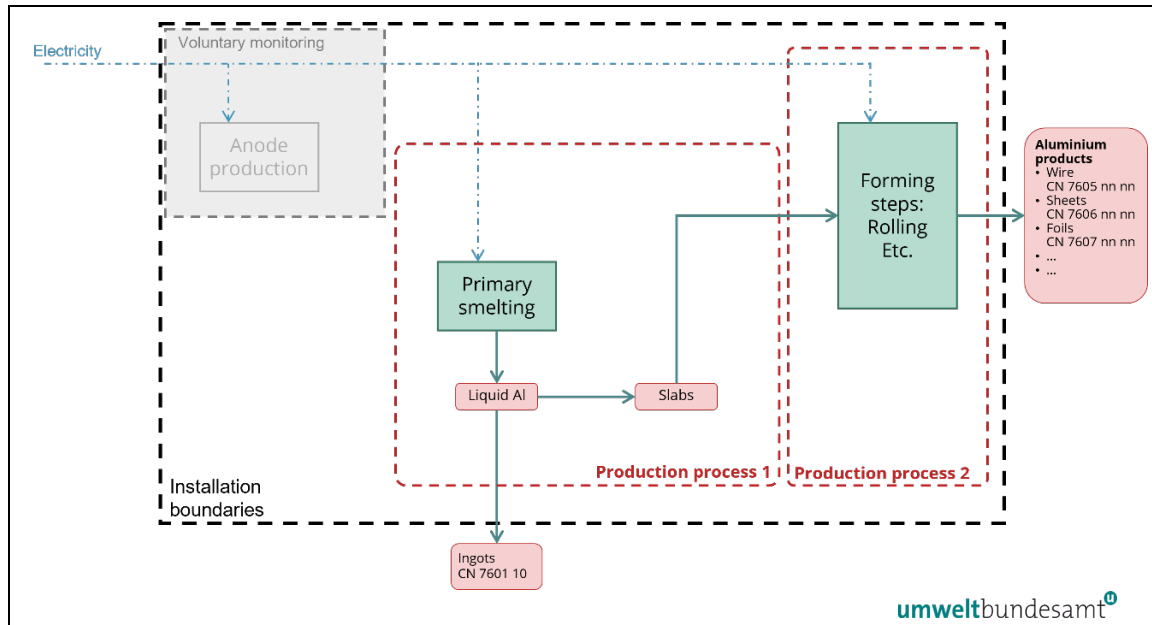

The fourth diagram (Figure 7-16) provides a complete monitoring approach for all source streams, for the example installation.

Figure 7-16: Aluminium example – complete monitoring approach

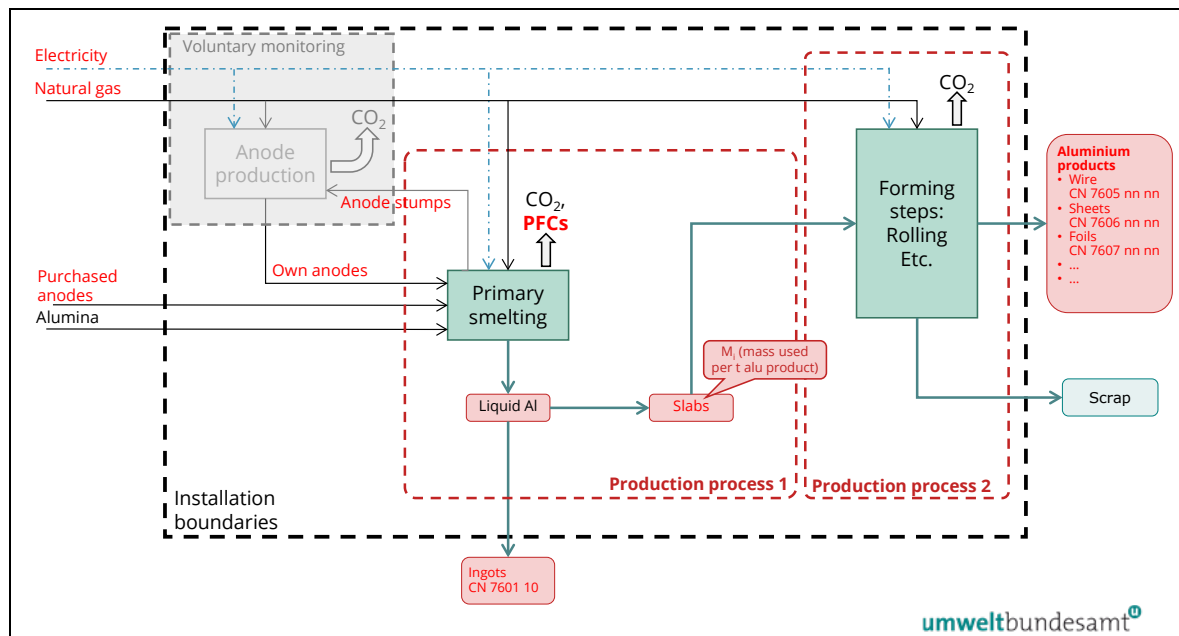

The inputs and outputs highlighted in red text in Figure 7-16 are the parameters that would need to be monitored by the operator in order to attribute emissions and determine direct and indirect specific embedded emissions for both production processes.

The direct and indirect emissions that are monitored in this example result from:

- Direct CO<sub>2</sub> emissions from fuel (natural gas) combustion, and from the process resulting from the consumption of carbon anodes.
- Direct emissions of PFCs formed during the electrolysis process.
- Indirect emissions from the electrical energy consumed by the production process.
- In the case of production process 2, embedded emissions in precursors (the slabs produced in process 1).

The inputs of precursors (with embedded emissions) and the activity level of the aluminium goods produced by each production process also need to be monitored.

Table 7-20 summarises the inputs and outputs from the two production processes that are monitored in order to determine total direct and indirect specific embedded emissions.

*Table 7-20: Input & production levels of the aluminium example*

<b>Production:</b>	<b>Ingots &amp; liquid aluminium, total</b>	<b>200 000 t</b>
	Ingots (sale):	80 000 t
	Primary aluminium into process 2 (slabs)	120 000 t
	<b>Aluminium products (process 2)</b>	
	Wire (CN 7605)	45 000 t
	Sheets (CN 7606)	60 000 t
	Foils (CN 7607)	8 000 t
	<b>Total Aluminium products (process 2)</b>	<b>113 000 t</b>
	Scrap <sup>144</sup> sold	7 000 t
<b>Inputs:</b>	Alumina	380 000 t
	Electrodes (sum self-produced and purchased, minus stumps)	69 000 t
	Natural gas (12 219 t for process 1, 1 962 t for process 2)	14 181 t

Whilst some unwrought aluminium is sold off site in the form of ingots (80 000 tonnes), 120 000 tonnes is used as a precursor in production process 2, and there is scrap of 7 000 tonnes at the end. No emissions are attributed to aluminium scrap, which as scrap has zero embedded emissions.

Table 7-21 summarises the calculation of direct emissions and their attribution to each production process. Table 7-22 provides the corresponding calculation for indirect emissions.

---

<sup>144</sup> Not a CBAM good

Table 7-21: Aluminium example – Installation's total direct emissions

Direct emissions CO <sub>2</sub> e	Emissions	Units
From electrodes (using factor 3,664 t CO <sub>2</sub> / t C):	252 816	t CO <sub>2</sub>
From natural gas (NCV = 48 GJ/t, EF=56,1 t CO <sub>2</sub> / TJ):	32 902	t CO <sub>2</sub>
From PFCs (using a method described in section 7.4.1.2)	25 282	t CO <sub>2</sub> e
Total Process 1 (primary aluminium)	<b>311 000</b>	<b>t CO<sub>2</sub>e</b>
Total process 2 (final aluminium products), emissions from natural gas	5 283	t CO <sub>2</sub>
<b>Total direct emissions of the installation</b>	<b>316 283</b>	<b>t CO<sub>2</sub></b>

Table 7-22: Aluminium example – Installation's total indirect emissions

Indirect emissions	Electricity consumed (MWh)	EF (t CO <sub>2</sub> / MWh)	Emissions (t CO <sub>2</sub> )
Process 1 (primary)	3 000 000	0,410 <sup>(145)</sup>	1 230 000
Process 2 (final products)	105 000	0,410	43 050
<b>Total indirect emissions</b>			<b>1 273 050</b>

Using the data in the tables above, direct and indirect specific embedded emissions are then calculated separately for each aggregated goods category as shown in Table 7-23.

Table 7-23: Example calculation of specific embedded emissions of complex final aluminium goods

	Production levels (t)	Process total emissions (t CO <sub>2</sub> e)	Mass ratio (M <sub>i</sub> ) of precursor (t / t)	SEE dir. (t CO <sub>2</sub> e / t)	SEE indir. (t CO <sub>2</sub> e / t)
<b>Process 1 (unwrought aluminium – ingots and slabs)</b>					
	Product		Direct	Indirect	
	Ingots	80 000			
	Slabs	120 000			
	<b>Total</b>	<b>200 000</b>	<b>311 000</b>	<b>1 230 000</b>	<b>1,555</b>
<b>Process 2 (final aluminium products)</b>					
<b>Precursor</b>	Slabs	120 000		1,062	1,651
<b>Aluminium products</b>		113 000	5 283	43 050	0,381
<b>Total embedded emissions of final aluminium products</b>				<b>1,698</b>	<b>6,912</b>

When calculating the total embedded emissions of final aluminium products above, the **mass ratio (M<sub>i</sub>)** of the precursor is taken account (for calculation rules see section 6.2.2.3).

<sup>145</sup> The emission factor is based on a fictitious country's electricity grid with 40% electricity from relatively old coal plants, and 60% hydropower. Note that hydropower can only be taken into account if a power purchase agreement exists between the installation and the producer of the electricity. Otherwise a default value provided by the Commission would have to be used.

This is the mass of unwrought aluminium slabs consumed per tonne of aluminium products, and is calculated as:

- Mass slabs / mass aluminium products:  $120\,000\text{ t} / 113\,000\text{ t} = \mathbf{1,062\text{ t/t}}$  (as above).

The direct and indirect  $SEE_i$  values of the precursor are then adjusted by this ratio i.e.:

- For  $SEE_i$  direct (precursor):  $1,555\text{ t CO}_2 / \text{t} \times 1,062\text{ t/t} = 1,651\text{ t CO}_2 / \text{t}$ .

Total direct and indirect specific embedded emissions of the final complex aluminium product are calculated by **adding** the  $SEE$  values of the precursor (adjusted by the  $M_i$ ) to the emissions of the production process for aluminium products, as above.

Using the above approach, the CBAM reporting obligation due for the import of final aluminium product into the EU during the transitional period may then be determined; for example, for the import of 100 tonnes of basic aluminium product e.g. sheets:

- **Transitional period (report only):**
  - Direct embedded emissions =  $100\text{ t} \times 1,698\text{ t CO}_2 / \text{t} = 169,8\text{ t CO}_2$
  - Indirect embedded emissions =  $100\text{ t} \times 6,912\text{ t CO}_2 / \text{t} = 691,2\text{ t CO}_2$

**Total: 861,0 t CO<sub>2</sub>**

## 7.5 Chemicals – Hydrogen sector

The textbox below signposts sector-specific sections in the Implementing Regulation, relevant for the CBAM transitional period.

---

### Implementing Regulation references:

- **Annex II**, Section 3 – Special provisions and emissions monitoring requirements by production route. Sub-section 3.6 (Hydrogen).
- **Annex IV**, Section 2 – Sector specific parameters for CBAM goods that should be reported by producers of goods to importers, in the Emissions Data Communication.



---

### 7.5.1 Sector-specific requirements for monitoring and reporting

Direct and indirect embedded emissions should be monitored in line with the methodology set out in the Implementing Regulation and outlined in section 6 of this guidance document.

#### 7.5.1.1 Emissions monitoring

Relevant emissions that should be monitored and reported for the hydrogen sector are:

- Carbon dioxide emissions (direct) from the fuel combustion process in the hydrogen or synthesis gas production process, primary and secondary steam



reforming of natural gas, or partial oxidation other hydrocarbons; from stationary plant only (excludes emissions from any mobile units such as vehicles).

- Carbon dioxide emissions (direct) resulting from the production of measurable heating (for the purpose of producing hot water or steam) and cooling that is consumed within the system boundaries of the production process, regardless of the location of the production of the heat (i.e. from on-site generation or from imports from off-site).
- Carbon dioxide emissions (direct) from electrolysis are minimal and so where these emissions are significant they are likely to result from ancillary plant.
- Carbon dioxide emissions (direct) resulting from emissions control (e.g. from carbonate raw materials such as soda ash used for acidic flue gas cleaning).

Direct emissions from the different source streams above are not reported separately but are added together to result in the total direct emissions for the installation or production process.

Indirect emissions from electricity consumed must be reported separately from direct emissions. Note that for this sector indirect emissions are only reported during the transitional period (and not during the definitive period).

#### 7.5.1.2 *Additional rules*

##### **Attribution of emissions where different products are simultaneously produced**

Additional rules apply for the attribution of direct (and where applicable indirect) emissions to the different products of the following production processes, where these products have been produced simultaneously:

- Electrolysis of water – where oxygen is released to the atmosphere, all emissions from the production process are attributed to the hydrogen product. However, if oxygen is collected and used in other production processes or is sold then molar proportions are used to attribute emissions, using the equation below.
- Chlor-Alkali electrolysis and the production of chlorates – molar proportions are used to attribute emissions to the hydrogen produced, using the equations below.

Indirect embedded emissions from electricity consumption are to be separately reported during the transitional period. An emission factor of zero for electricity may be used where electricity is certified<sup>146</sup> to be produced from renewable sources. Such certification is required for the purpose of importing “green hydrogen” under the EU’s renewable energy framework.

---

<sup>146</sup> In accordance with Commission Delegated Regulation (EU) 2023/1184 supplementing Directive (EU) 2018/2001 [...] by establishing a Union methodology setting out detailed rules for the production of renewable liquid and gaseous transport fuels of non-biological origin. See [http://data.europa.eu/eli/reg\\_del/2023/1184/oj](http://data.europa.eu/eli/reg_del/2023/1184/oj)

## Electrolysis of water

Where the co-product oxygen is collected and/or where direct or indirect emissions are not equal to zero, emissions from the process are attributed to hydrogen based on molar proportions using the following equation.

$$Em_{H_2} = Em_{total} \left( 1 - \frac{\frac{m_{O_2,sold}}{M_{O_2}}}{\frac{m_{H_2,prod}}{M_{H_2}} + \frac{m_{O_2,prod}}{M_{O_2}}} \right)$$

Where:

$Em_{H_2}$  ... Either direct or indirect emissions attributed to hydrogen produced over the reporting period, expressed in tonnes of CO<sub>2</sub>

$Em_{total}$  ... Either direct or indirect emissions of the whole production process over the reporting period, expressed in tonnes of CO<sub>2</sub>

$m_{O_2,sold}$  ... Mass of oxygen sold or used in the installation over the reporting period, expressed in tonnes

$m_{O_2,prod}$  ... Mass of oxygen produced over the reporting period, expressed in tonnes

$m_{H_2,prod}$  ... Mass of hydrogen produced over the reporting period, expressed in tonnes

$M_{O_2}$  ... Molar mass of O<sub>2</sub> (31,998 kg/kmol)

$M_{H_2}$  ... Molar mass of H<sub>2</sub> (2,016 kg/kmol)

## Chlor-Alkali electrolysis and production of chlorates

Where direct or indirect emissions are not equal to zero, then emissions are attributed to the hydrogen fraction based on molar proportions using the following equations:

Chlor-Alkali electrolysis:

$$Em_{H_2,sold} = Em_{total} \left( \frac{\frac{m_{H_2,sold}}{M_{H_2}}}{\frac{m_{H_2,prod}}{M_{H_2}} + \frac{m_{Cl_2,prod}}{M_{Cl_2}} + \frac{m_{NaOH,prod}}{M_{NaOH}}} \right)$$

Production of Sodium Chlorate:

$$Em_{H_2,sold} = Em_{total} \left( \frac{\frac{m_{H_2,sold}}{M_{H_2}}}{\frac{m_{H_2,prod}}{M_{H_2}} + \frac{m_{NaClO_3,prod}}{M_{NaClO_3}}} \right)$$

Where:

$Em_{H_2,sold}$  ... Either direct or indirect emissions attributed to hydrogen produced over the reporting period, expressed in tonnes of CO<sub>2</sub>

$Em_{total}$  ... Either direct or indirect emissions of the whole production process over the reporting period, expressed in tonnes of CO<sub>2</sub>

$m_{H_2,sold}$  ... Mass of hydrogen sold or used as precursor over the reporting period, expressed in tonnes

$m_{H_2,prod}$  ... Mass of hydrogen produced over the reporting period, expressed in tonnes

$m_{Cl_2,prod}$  ... Mass of chlorine produced over the reporting period, expressed in tonnes

$m_{NaOH,prod}$  ... Mass of sodium hydroxide (caustic soda) produced over the reporting period, expressed in tonnes, calculated as 100% NaOH

$m_{NaClO_3,prod}$  ... Mass of sodium chlorate produced over the reporting period, expressed in tonnes, calculated as 100% NaClO<sub>3</sub>

$M_{H_2}$  ... Molar mass of H<sub>2</sub> (2,016 kg/kmol)

$M_{Cl_2}$  ... Molar mass of Cl<sub>2</sub> (70,902 kg/kmol)

$M_{NaOH}$  ... Molar mass of NaOH (39,997 kg/kmol)

$M_{NaClO_3}$  ... Molar mass of NaClO<sub>3</sub> (106,438 kg/kmol)

## Exclusions

As an operator, you should note that only the production of pure hydrogen or mixtures of hydrogen with nitrogen usable in ammonia production shall be considered. Not covered are the production of synthesis gas or of hydrogen within refineries or organic chemical installations, where the hydrogen is exclusively used within those plants and not used for the production of goods under the CBAM Regulation.

### 7.5.1.3 Additional reporting requirements

The following Table 7-24 lists out the additional information that should be provided by you as an operator to importers, in your emissions data communication to them.

Table 7-24: Additional chemical sector parameters requested in the CBAM report

Aggregated good category	Reporting requirement in the quarterly report
Hydrogen	– None

These parameters depend on the goods produced. There is no additional reporting required for hydrogen.

### 7.5.2 Worked examples for the hydrogen sector

#### 7.5.2.1 Example 1 – methane steam reforming

The following worked example shows how specific embedded emissions are derived for hydrogen produced by the steam reforming production route.

The resulting embedded emissions of imports into the EU are then calculated at the end of the example for reporting in the transitional period.

The diagram below gives an outline view of the installation and shows the system boundaries as a hatched line for the single production process. The physical units carrying out the production process have been grouped under 'steam reforming' and the inputs and outputs and sources of emissions have been identified.

Figure 7-17: Hydrogen example No.1 – Overview and complete monitoring approach for hydrogen

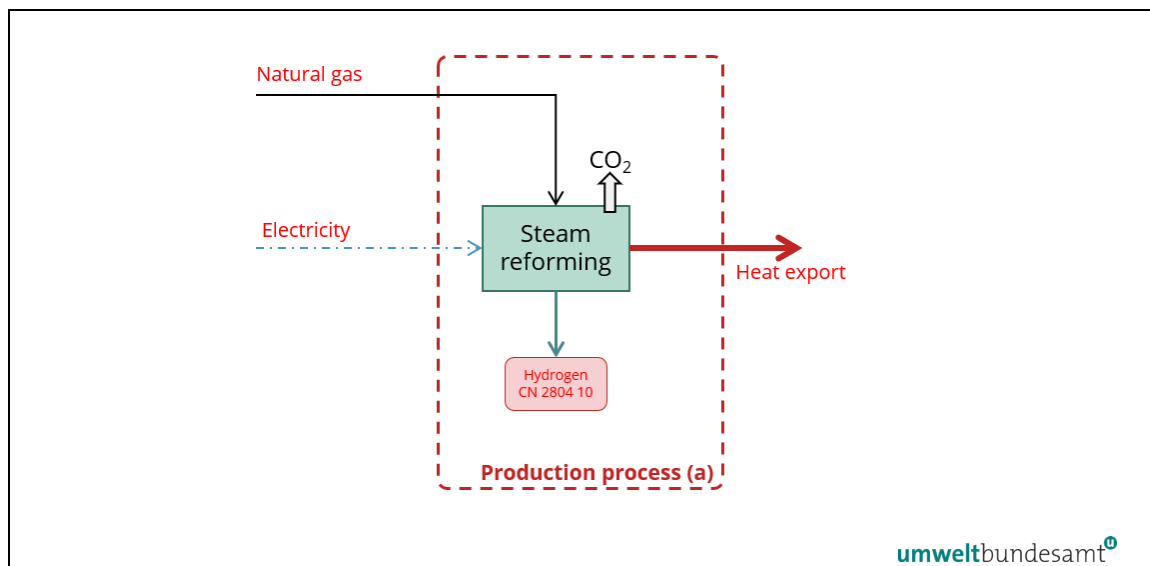

A single production process is defined for steam reforming. Inputs are natural gas (both as a raw material / feedstock for the process, and as a fuel) and electrical energy. Outputs are hydrogen product and heat exported to other parts of the installation or to a district heating network.

The inputs and outputs highlighted in red text in Table 7-25 are the parameters that would need to be monitored by the operator in order to attribute emissions and determine direct and indirect specific embedded emissions for the production process.

The direct and indirect emissions that are monitored in this example result from:

- Direct emissions from fuel combustion and from the steam reforming process<sup>147</sup>.
- For the purpose of calculating attributed emissions of the process, an equivalent of emissions associated with the heat export needs to be determined, and subtracted from attributed emissions. See section 6.2.2.2 for calculation approach, and section 6.7.2 for monitoring requirements.
- Indirect emissions from the electrical energy consumed by the production process.

The activity level of the hydrogen good produced also needs to be monitored.

Table 7-25 summarises the inputs and outputs from the process that are monitored for determining total direct and indirect specific embedded emissions.

<sup>147</sup> Emissions of carbon monoxide (CO) to the atmosphere from the process are not counted as outgoing source stream in the mass balance but are considered as the molar equivalent amount of CO<sub>2</sub> emissions.

Table 7-25: Example calculation of total direct emissions attributed to hydrogen net of emissions for a heat export.

Direct emissions	AD (t)	NCV (GJ/t)	Energy (TJ)	EF (t CO <sub>2</sub> /TJ)	Emissions (t CO <sub>2</sub> )
Input natural gas	190 000	48	9 120	56,1	511 632
Heat export			-800	56,1	-44 800
<b>Total direct emissions of the installation</b>					<b>466 832</b>

Total direct emissions of the installation result from one single source stream (natural gas). There is no need to distinguish combustion and process emissions for this purpose. In this example, these are wholly attributed to the hydrogen product, net of emissions attributed to a heat export. If the almost pure CO<sub>2</sub> produced by this process were to be captured and transferred to a geological CO<sub>2</sub> storage site, the related emissions could be deducted, provided the receiving installation carries out monitoring under the CBAM or an equivalent MRV system (see section 6.5.6.2).

Table 7-26: Total indirect emissions attributed to hydrogen

Indirect emissions	AD (MWh)	EF (t CO <sub>2</sub> / MWh)	Emissions (t CO <sub>2</sub> )
Electricity consumption	33 000	0,367 <sup>148</sup>	12 096
<b>Total indirect emissions of the installation</b>			<b>12 096</b>

The emission factor (EF) for electricity used in Table 7-26 above is based on the emission factor for natural gas, using an efficiency of a combined cycle power plant. Total indirect emissions of the installation attributed to the hydrogen product are 12 096 t CO<sub>2</sub>. Using the data in the tables above, in Table 7-26 the specific embedded emissions for hydrogen are calculated, using direct and indirect emissions and the production level for hydrogen in the reporting period.

Table 7-27: Calculation of embedded emissions of hydrogen product (example)

Production	Activity level (t)	Process total emissions (t CO <sub>2</sub> )		SEE (t CO <sub>2</sub> / t H <sub>2</sub> )	
		Direct	Indirect	Direct	Indirect
Hydrogen	55 000	466 832	12 096	<b>8,488</b>	<b>0,220</b>

Using the above approach, the CBAM reporting obligation for the import of hydrogen product into the EU during the transitional period may then be determined; for example, for the import of 100 tonnes of hydrogen product produced by methane steam reformatting:

<sup>148</sup> Source of EF is Annex VIII, Table 1 – EF for natural gas is 56,1 t CO<sub>2</sub>/TJ multiplied by 0,0036 to convert this value into its equivalent value of 0,202 t CO<sub>2</sub> / MWh. Then 55% efficiency for a combined cycle gas power plant is assumed.

- **Transitional period (report only):**

- Direct embedded emissions =  $100 \text{ t} \times 8,488 \text{ t} / \text{t CO}_2 = 848,8 \text{ t CO}_2$
- Indirect embedded emissions =  $100 \text{ t} \times 0,220 \text{ t} / \text{t CO}_2 = 22,0 \text{ t CO}_2$

**Total: 870,8 t CO<sub>2</sub>**

### 7.5.2.2 Example 2 – chlor-alkali electrolysis

The following worked example shows how specific embedded emissions are derived for hydrogen product, produced by the chlor-alkali production route.

The resulting embedded emissions of imports into the EU are then calculated at the end of the example, for reporting in the transitional period.

The diagram below gives an outline view of the installation and shows the system boundaries as a hatched line for the single production process. The physical units carrying out the production process have been grouped under ‘Electrolysis’ and the inputs and outputs and sources of emissions have been identified.

Figure 7-18: Hydrogen example No.2 – Overview and complete monitoring approach for hydrogen

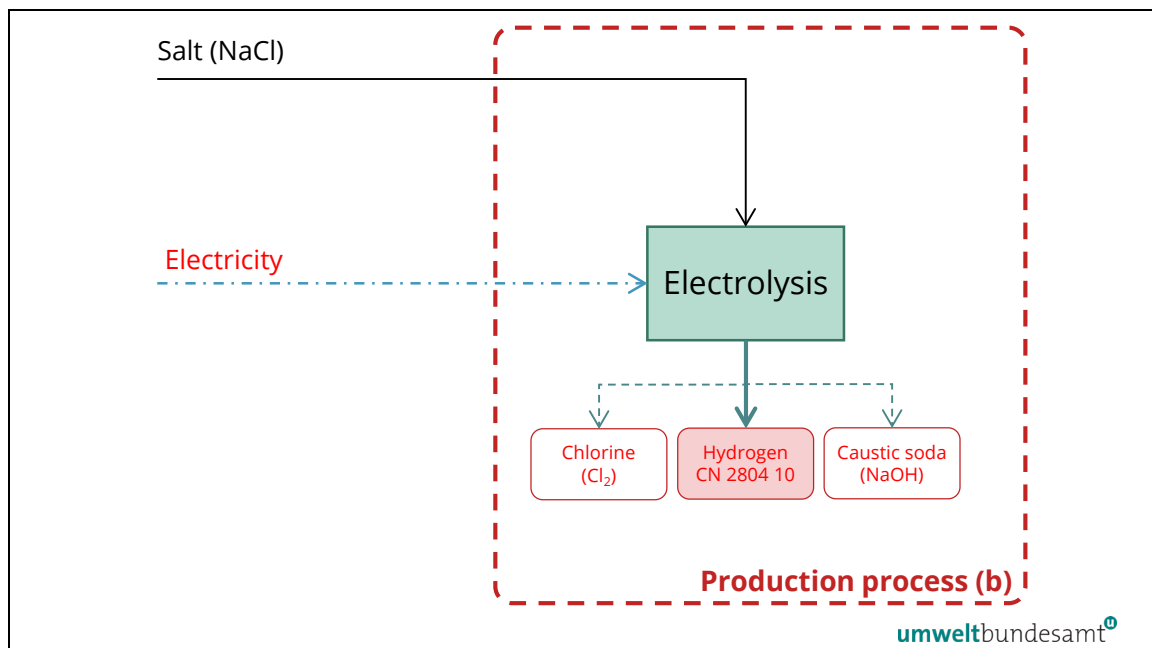

A single production process is defined for chlor-alkali electrolysis. Inputs are salt as a feedstock and electrical energy for electrolysis. Outputs are co-products chlorine, caustic soda and hydrogen product. There are no direct emissions, and no source streams to be monitored.

The inputs and outputs highlighted in red text above are the parameters that would need to be monitored by the operator in order to attribute emissions and determine direct and indirect specific embedded emissions for the production process.

There are no direct emissions in this example. Indirect emissions that are monitored in this example result from:

- Electrical energy consumed by the production process.

The activity levels of chlorine and caustic soda **as well as** that for the hydrogen good produced need to be monitored in order to perform the required split of emissions by product. For the example it is assumed that only a part of the hydrogen produced is also sold.

Table 7-28 summarises the inputs and outputs from the production process that are monitored in order to determine total specific embedded emissions.

*Table 7-28: Example production levels for the reporting period and calculation of the molar proportions*

Product	AD (t)	Molar mass (kg/kmol)	Molar proportion AD / molar mass (t kmol / kg)
Hydrogen (H <sub>2</sub> ) produced	5 687	2,016	<b>2 820,8</b>
Hydrogen (H <sub>2</sub> ) sold	1 200		<b>595,2</b>
Chlorine (Cl <sub>2</sub> ) produced	200 000	70,902	<b>2 820,8</b>
Caustic Soda (NaOH) produced	225 647	39,997	<b>5 641,6</b>

As hydrogen product is produced simultaneously alongside chlorine and caustic soda, its share of emissions resulting from the production process are attributed to it using the chlor-alkali electrolysis equation above (section 7.5.1.2). The attribution factor for the sold hydrogen fraction in this equation is calculated using the molar proportions in Table 7-28 above:

- Attribution factor for hydrogen =  $595,2 / (2\ 820,8 + 2\ 820,8 + 5\ 641,6) = 0,0528$

*Table 7-29: Total indirect emissions for the chlor-alkali electrolysis process*

Indirect emissions	MWh	EF (t CO <sub>2</sub> / MWh)	Emissions (t CO <sub>2</sub> )
Electricity consumption	520 000	0,367	190 604
<b>Total indirect emissions of the installation</b>			<b>190 604</b>

The attribution factor of 0,0528 calculated above is used to attribute indirect emissions to the hydrogen fraction, as below:

- Indirect embedded emissions attributed to hydrogen product =  $0,0528 \times 190\ 604\ \text{t CO}_2 = \mathbf{10\ 064\ \text{t CO}_2}$
- Dividing by hydrogen production level gives the specific indirect embedded emissions:  $10\ 064\ \text{t CO}_2 / 1\ 200\ \text{t H}_2 = \mathbf{8,387\ \text{t CO}_2 / \text{t H}_2}$

Using the above approach, the CBAM reporting obligation due for the import of hydrogen into the EU during the transitional period may then be determined; for

example, for the import of 100 tonnes of hydrogen produced by chlor-alkali electrolysis product:

- **Transitional period (report only):**
    - Direct embedded emissions = 0 t CO<sub>2</sub>
    - Indirect embedded emissions = 100 t x 8,387 t CO<sub>2</sub> / t = 838,7 t CO<sub>2</sub>
- Total: 837,9 t CO<sub>2</sub>**

## 7.6 Electricity “as a good” (i.e. imported into the EU)

The textbox below signposts sector-specific sections in the Implementing Regulation, relevant for the CBAM transitional period.

---

### Implementing Regulation references:

- **Annex II**, Section 3 – Special provisions and emissions monitoring requirements by production route. Sub-section 3.19 (Electricity)
  - **Annex III**, Section D – Monitoring of electricity, sub-sections D.1 to D.2
- 



Where electricity is imported into the EU as a good on its own, i.e. not included in the indirect emissions of a (tangible) good, specific rules apply. Firstly, only direct emissions exist. Secondly, it is the exception from the rule that actual emissions are monitored instead of using a default factor for the embedded emissions. For calculating those emissions, the formula given in section 6.6 is used. For the emission factor of electricity, the rules given in section D.2 of Annex III to the Implementing Regulation have to be applied, which are explained below.

The following options for determining the emission factor of electricity apply:

- (a) As the default case, the specific default value for a third country, group of third countries or region within a third country shall be used. That value is determined by the Commission based on the best data available them. These are **CO<sub>2</sub> emission factors**<sup>149</sup> based on data from the International Energy Agency (IEA) and are provided by the Commission in the CBAM Transitional Registry.
- (b) Where no specific default value is available pursuant to point (a), the CO<sub>2</sub> emission factor in the EU as set out in point D.2.2 of this Annex shall be used. It is also based on IEA data and provided via the CBAM Transitional Registry.
- (c) Where a reporting declarant submits sufficient evidence based on official and public information to demonstrate that **the applicable CO<sub>2</sub> emission factor is lower** than the values in accordance with points (a) and (b), and where the

---

<sup>149</sup> The CBAM Regulation defines: ‘CO<sub>2</sub> emission factor’, means the weighted average of the CO<sub>2</sub> intensity of electricity produced from fossil fuels within a geographic area. The CO<sub>2</sub> emission factor is the result of the division of the CO<sub>2</sub> emission data of the electricity sector by the gross electricity generation based on fossil fuels in the relevant geographic area. It is expressed in tonnes of CO<sub>2</sub> per megawatt-hour.



conditions provided in section 7.6.1 are fulfilled, the reporting declarant may determine the CO<sub>2</sub> emission factor based on the method described in that section.

- (d) The **actual emissions data** of a specific electricity producing installation may be used, if the criteria given in section 7.6.2 are met, and the calculation is based on data determined according to Annex III to the Implementing Regulation, as explained in section 7.6.2.

### 7.6.1 CO<sub>2</sub> emission factor based the reporting declarant's data

For the purpose of point (c) mentioned above, the reporting declarant shall provide the datasets from alternative **official sources**, including national statistics **for the five-years period ending two years before the reporting**. This timeframe was chosen to reflect the impact of decarbonisation policies (e.g. increase in renewable energy production) as well as climatic conditions (e.g. particularly cold years) on the yearly electricity supply in the countries concerned.

For this purpose, the reporting declarant shall calculate the yearly CO<sub>2</sub> emission factors per fossil fuel technology and its respective gross electricity generation in the country exporting electricity to the EU, based on the following equation:

$$Em_{el,y} = \frac{\sum_i^n EF_i \times E_{el,i,y}}{E_{el,y}}$$

Where:

$Em_{el,y}$  is the yearly CO<sub>2</sub> emission factor for all fossil fuel technologies in the given year in the third country capable of exporting electricity to the EU;

$E_{el,y}$  is the total gross electricity generation from all fossil fuel technologies in that year;

$EF_i$  is the CO<sub>2</sub> emission factor for each fossil fuel technology 'i', and

$E_{el,i,y}$  is the yearly gross electricity generation for each fossil fuel technology 'i'.

Then the CO<sub>2</sub> emission factor is calculated as a moving average of those years:

$$Em_{el} = \frac{\sum_{y-6}^{y-2} Em_{el,i}}{5}$$

Where:

$Em_{el}$  is the CO<sub>2</sub> emission factor resulting from the moving average of the CO<sub>2</sub> emission factors of the 5 previous years, starting from the current year, minus two years, until the current year, minus 6 years;

$Em_{el,y}$  is the CO<sub>2</sub> emission factor for each year 'i';

$i$  is the variable index for the years to consider, and

$y$  is the current year.

### 7.6.2 *CO<sub>2</sub> emission factor based on actual CO<sub>2</sub> emissions of the installation*

For allowing an importer of electricity to use actual emissions data of a specific electricity producing installation, all of the criteria (a) to (d) provided in Section 5 of Annex IV to the CBAM Regulation have to be fulfilled, which are:

- (a) The amount of electricity for which the use of actual embedded emissions is claimed is covered by a **power purchase agreement** between the authorised CBAM declarant and a producer of electricity located in a third country;
- (b) The installation producing electricity is **either directly connected to the Union transmission system or** it can be demonstrated that at the time of export there was **no physical network congestion** at any point in the network between the installation and the Union transmission system;
- (c) The installation producing electricity **does not emit more than 550 grammes of CO<sub>2</sub>** of fossil fuel origin **per kWh** of electricity;
- (d) The amount of electricity for which the use of actual embedded emissions is claimed has been **firmly nominated to the allocated interconnection capacity** by all responsible transmission system operators in the country of origin, the country of destination and, if relevant, each country of transit, and the nominated capacity and the production of electricity by the installation refer to the same period of time, which shall not be longer than one hour.

Furthermore, the said installation must determine the emission factor of electricity in line with Annex III to the implementing Regulation, i.e. as explained in section 6.7.3 or section 6.7.4 in case of CHP. The installation's direct emissions are to be determined as discussed in section 6.5.

## 8 EXEMPTIONS FROM THE CBAM

During the transitional period certain general exemptions apply, which are listed below.

---

### Implementing Regulation references:

- The CBAM Regulation (EU) 2023/956, Section I, Article 2 Scope, paragraphs 3, 4 and 7; Annex III Third countries and territories outside the scope of this Regulation for the purpose of Article 2.
- 

### De minimis exemption

Small quantities (de minimis) of imported goods that are in scope for the CBAM may be automatically treated as exempt from the provisions of the CBAM legislation, provided that the value of these goods is negligible, that is to say does not exceed EUR 150 per consignment<sup>150</sup>. This exemption does **not** apply during the transitional phase.

### Military use exemption<sup>151</sup>

An exemption applies to any goods imported to be used by the military authorities of Member States, or under agreement with those of a non-EU country, under the EU's Common Security and Defence Policy, or under NATO.

### EFTA exemption

Countries which apply the EU ETS (Norway, Iceland, Liechtenstein), or which have an ETS fully linked to the EU ETS (Switzerland), are exempted from the CBAM.

Countries exempted for goods other than electricity are listed in Annex III, section 1 of the CBAM Regulation; countries exempted for electricity would be added to section 2 of that Annex, which is currently empty.

### Limited exemption for electricity imports

Imports of electricity from non-EU countries are covered by the CBAM, unless the non-EU country is so closely integrated with the EU internal market for electricity that a technical solution to apply the CBAM to these imports cannot be found; this exemption only applies in limited circumstances and is subject to the conditions outlined in Article 2 of the CBAM Regulation.

---

<sup>150</sup> Article 23 of Council Regulation (EC) No 1186/2009. See: <https://eur-lex.europa.eu/LexUriServ/LexUriServ.do?uri=OJ:L:2009:324:0023:0057:EN:PDF>

<sup>151</sup> Commission Delegated Regulation (EU) 2015/2446 of 28 July 2015 supplementing Regulation (EU) No 952/2013 of the European Parliament and of the Council as regards detailed rules concerning certain provisions of the Union Customs Code.

## Annex A List of abbreviations

<b>Abbreviation</b>	<b>Full term</b>
<b>AD</b>	Activity Data
<b>AEM</b>	Anode Effect Minutes
<b>AEO</b>	Anode Effect Overvoltage
<b>AL</b>	Activity Level
<b>AOD</b>	Argon Oxygen Decarburisation.
<b>BAT</b>	Best Available Techniques
<b>BF</b>	Biomass Fraction
<b>BFG</b>	Blast Furnace Gas
<b>BOF</b>	Basic Oxygen Furnace
<b>BOFG</b>	Basic Oxygen Furnace Gas
<b>BREFs</b>	Best Available Techniques reference documents
<b>CA</b>	Competent Authority
<b>CBAM</b>	Carbon Border Adjustment Mechanism, the
<b>CCR</b>	Clinker to Cement Ratio
<b>CCS</b>	Carbon Capture and Storage
<b>CCU</b>	Carbon Capture and Utilisation
<b>CCUS</b>	Carbon Capture, Utilisation and Storage
<b>CEMS</b>	Continuous Emission Measurement Systems
<b>CF</b>	Conversion Factor
<b>CFP</b>	Carbon footprint of products
<b>CHP</b>	Combined Heat and Power
<b>CKD</b>	Cement Kiln Dust
<b>CN</b>	Combined nomenclature
<b>COG</b>	Coke Oven Gas
<b>DRI</b>	Direct Reduced Iron
<b>EAF</b>	Electric Arc Furnace
<b>EF</b>	Emission Factor
<b>EFTA</b>	European Free Trade Area
<b>EORI</b>	Economic Operator Registration and Identification
<b>ETS</b>	Emissions Trading System
<b>EU ETS</b>	EU Emissions Trading System
<b>EUA</b>	EU Allowances (used in the EU ETS)
<b>EUR</b>	Euro (currency)

<b>Abbreviation</b>	<b>Full term</b>
<b>FAR</b>	Free Allocation Rules (Regulation 2019/331) <sup>152</sup>
<b>GHG</b>	Greenhouse Gas
<b>GWP</b>	Global Warming Potential
<b>HBI</b>	Hot Briquetted Iron
<b>HS</b>	Harmonised System (for international trade)
<b>IEA</b>	International Energy Agency
<b>ISO</b>	International Organization for Standardization
<b>LULUCF</b>	Land-use, land change and forestry (criteria)
<b>MMD</b>	Monitoring Methodology Documentation
<b>MRR</b>	Monitoring and Reporting Regulation (Regulation 2018/2066) <sup>153</sup>
<b>MRV</b>	Monitoring, Reporting and Verification
<b>MS</b>	Member State(s)
<b>MWh</b>	Megawatt-hour
<b>NCV</b>	Net Calorific Value
<b>NPI</b>	Nickel pig iron
<b>OF</b>	Oxidation Factor
<b>PCI</b>	Pulverised Coal Injection
<b>PEMS</b>	Predictive Emission Monitoring System
<b>PFC</b>	Perfluoro-carbon
<b>PoS</b>	Proofs of Sustainability
<b>RED II</b>	Renewable Energy Directive, re-cast
<b>SEE</b>	Specific embedded emissions
<b>TARIC</b>	Integrated Tariff of the European Union database
<b>TJ</b>	Terajoules
<b>TSO</b>	Transmission System Operator
<b>UCC</b>	Union Custom Code
<b>UN/LOCODE</b>	United Nations Code for Trade and Transport Location

<sup>152</sup> Free Allocation Rules (Commission Delegated Regulation (EU) 2019/331 of 19 December 2018 determining transitional Union-wide rules for harmonised free allocation of emission allowances pursuant to Article 10a of Directive 2003/87/EC of the European Parliament and of the Council)

<sup>153</sup> Monitoring and Reporting Regulation (Commission Implementing Regulation (EU) 2018/2066 of 19 December 2018 on the monitoring and reporting of greenhouse gas emissions pursuant to Directive 2003/87/EC of the European Parliament and of the Council and amending Commission Regulation (EU) No 601/2012

## Annex B

## List of definitions

<b>Term</b>	<b>Definition</b>
<b>‘Accuracy’</b>	means the closeness of the agreement between the result of a measurement and the true value of the particular quantity or a reference value determined empirically using internationally accepted and traceable calibration materials and standard methods, taking into account both random and systematic factors;
<b>‘Activity data’</b>	means the amount of fuels or materials consumed or produced by a process relevant for the calculation-based methodology, expressed in terajoules (TJ), mass in tonnes or (for gases) volume in normal cubic metres, as appropriate
<b>‘Actual emissions’</b>	means the emissions calculated based on primary data from the production processes of goods and from the production of electricity consumed during those processes as determined in accordance with the methods set out in Annex IV [to the Implementing Regulation]
<b>‘Activity level’</b>	means the quantity of goods produced (expressed in MWh for electricity, or in tonnes for other goods) within the boundaries of a production process
<b>‘Agricultural, aquaculture, fisheries and forestry residues’</b>	means residues that are directly generated by agriculture, aquaculture, fisheries and forestry and that do not include residues from related industries or processing
<b>‘Authorised CBAM declarant’</b>	means a person authorised by the competent authority in accordance with Article 17 of the CBAM Regulation (EU) 2023/956
<b>‘Batch’</b>	means an amount of fuel or material representatively sampled and characterised, and transferred as one shipment or continuously over a specific period of time
<b>‘Biomass’</b>	means the biodegradable fraction of products, waste and residues from biological origin from agriculture, including vegetal and animal substances, from forestry and related industries, including fisheries and aquaculture, as well as the biodegradable fraction of waste, including industrial and municipal waste of biological origin
<b>‘Biomass fraction’</b>	means the ratio of carbon stemming from biomass to the total carbon content of a fuel or material, expressed as a fraction
<b>‘Calculation factors’</b>	means net calorific value, emission factor, preliminary emission factor, oxidation factor, conversion factor, carbon content or biomass fraction

<b>Term</b>	<b>Definition</b>
<b>‘Calibration’</b>	means the set of operations, which establishes, under specified conditions, the relations between values indicated by a measuring instrument or measuring system, or values represented by a material measure or a reference material and the corresponding values of a quantity realised by a reference standard
<b>‘Carbon price’</b>	means the monetary amount due in a third country, under a carbon emissions reduction scheme, in the form of a tax, levy or fee or in the form of emission allowances under a greenhouse gas emissions trading system, calculated on greenhouse gases covered by such a measure, and released during the production of goods
<b>‘CBAM certificate’</b>	means a certificate in electronic format corresponding to one tonne of CO <sub>2</sub> e of embedded emissions in goods
<b>‘CO<sub>2</sub> emission factor’</b>	means the weighted average of the CO <sub>2</sub> intensity of electricity produced from fossil fuels within a geographic area. The CO <sub>2</sub> emission factor is the result of the division of the CO <sub>2</sub> emission data of the electricity sector by the gross electricity generation based on fossil fuels in the relevant geographic area. It is expressed in tonnes of CO <sub>2</sub> per megawatt-hour
<b>‘Combined nomenclature’ (CN)</b>	<p>means the classification of goods, designed to meet the needs of: i) the Common customs tariff, setting import duties for products imported into the European Union (EU), as well as the Integrated tariff of the European Communities (Taric), incorporating all EU and trade measures applied to goods imported into and exported out of the EU; ii) the international trade statistics of the EU.</p> <p>The CN provides the means of collecting, exchanging and publishing data on EU international trade statistics. It is also used for the collection and publication of international trade statistics in intra-EU trade.<sup>154</sup></p>
<b>‘Combustion emissions’</b>	means greenhouse gas emissions occurring during the exothermic reaction of a fuel with oxygen
<b>‘Competent authority’</b>	means the authority designated by each Member State in accordance with Article 11 of the CBAM Regulation (EU) 2023/956
<b>‘Continuous emission measurement’ (CEM)</b>	means a set of operations having the objective of determining the value of a quantity by means of periodic measurements, applying either measurements in the stack or extractive procedures with a measuring instrument located close to the stack, whilst excluding measurement methodologies based on the collection of individual samples from the stack

<sup>154</sup> For definition see: [https://ec.europa.eu/eurostat/statistics-explained/index.php?title=Glossary:Combined\\_nomenclature\\_\(CN\)](https://ec.europa.eu/eurostat/statistics-explained/index.php?title=Glossary:Combined_nomenclature_(CN))

<b>Term</b>	<b>Definition</b>
<b>‘Complex goods’</b>	means goods other than simple goods
<b>‘Conservative’</b>	means that a set of assumptions is defined in order to ensure that no under-estimation of reported emissions or over-estimation of production of heat, electricity or goods occurs
<b>‘Conversion factor’</b>	means the ratio of carbon emitted as CO <sub>2</sub> to the total carbon contained in the source stream before the emitting process takes place, expressed as a fraction, considering CO emitted to the atmosphere as the molar equivalent amount of CO <sub>2</sub>
<b>‘Customs declarant’</b>	means the declarant as defined in Article 5(15) of Regulation (EU) No 952/2013 lodging a customs declaration for release for free circulation of goods in its own name or the person in whose name such a declaration is lodged
<b>‘CCUS system’</b>	means a group of economic operators with technically connected installations and transport equipment for CO <sub>2</sub> capture, transport, use in production of goods, or geological storage
<b>‘Data flow activities’</b>	mean activities related to the acquisition, processing and handling of data that are needed to draft an emissions report from primary source data
<b>‘Data set’</b>	<p>means one type of data, either at installation level or production process level as relevant in the circumstances, as any of the following:</p> <ul style="list-style-type: none"> <li>(a) the amount of fuels or materials consumed or produced by a production process as relevant for the calculation-based methodology, expressed in terajoules, mass in tonnes, or for gases as volume in normal cubic metres, as appropriate, including for waste gases;</li> <li>(b) a calculation factor;</li> <li>(c) net quantity of measurable heat, and the relevant parameters required for determining this quantity, in particular: i) mass flow of heat transfer medium; and ii) enthalpy of transmitted and returned heat transfer medium, as specified by composition, temperature, pressure and saturation;</li> <li>(d) quantities of non-measurable heat, specified by the relevant quantities of fuels used for producing the heat, and the net calorific value (NCV) of the fuel mix;</li> <li>(e) quantities of electricity;</li> <li>(f) quantities of CO<sub>2</sub> transferred between installations;</li> <li>(g) quantities of precursors received from outside the installation, and their relevant parameters, such as country of origin, used production route, specific direct and indirect emissions, carbon price due;</li> </ul>



<b>Term</b>	<b>Definition</b>
	(h) parameters relevant for a carbon price due
<b>‘Default value’</b>	means a value, which is calculated or drawn from secondary data, which represents the embedded emissions in goods
<b>‘Direct emissions’</b>	means emissions from the production processes of goods including emissions from the production of heating and cooling that is consumed during the production processes, irrespective of the location of the production of the heating and cooling
<b>‘Eligible monitoring, reporting and verification (MRV) system’</b>	means the MRV systems where the installation is established <sup>155</sup> for the purpose of a ‘carbon pricing scheme’, or compulsory emission monitoring schemes, or an emission monitoring scheme at the installation which can include verification by an accredited verifier, in accordance with Article 4(2) of the CBAM Implementing Regulation
<b>‘Embedded emissions’</b>	means direct emissions released during the production of goods and indirect emissions from the production of electricity that is consumed during the production processes, calculated in accordance with the methods set out in Annex IV and further specified in the Implementing Regulations adopted pursuant to Article 7(7)
<b>‘Emissions’</b>	mean the release of greenhouse gases into the atmosphere from the production of goods
<b>‘Emission factor’</b>	means the average emission rate of a greenhouse gas relative to the activity data of a source stream assuming complete oxidation for combustion and complete conversion for all other chemical reactions
<b>‘Emission factor’ for electricity</b>	means the default value, expressed in CO <sub>2</sub> e, representing the emission intensity of electricity consumed in production of goods.
<b>‘Emission source’</b>	means a separately identifiable part of an installation or a process within an installation, from which relevant greenhouse gases are emitted
<b>EU ETS</b>	means the system for greenhouse gas emissions allowance trading within the Union in respect of activities listed in Annex I to Directive 2003/87/EC other than aviation activities
<b>‘Fossil carbon’</b>	means inorganic and organic carbon that is not biomass
<b>‘Fossil fraction’</b>	means the ratio of fossil and inorganic carbon to the total carbon content of a fuel or material, expressed as a fraction
<b>‘Fugitive emissions’</b>	means irregular or unintended emissions from sources that are not localised, or too diverse or too small to be monitored individually

<sup>155</sup> Refers to the jurisdiction in which the installation is located.

<b>Term</b>	<b>Definition</b>
<b>‘Goods’</b>	means goods listed in Annex I to the CBAM Regulation (EU) 2023/956 [and Annex II to the Implementing Regulations]
<b>‘Greenhouse gases’</b>	mean greenhouse gases as specified in Annex I to the CBAM Regulation (EU) 2023/956 [and Annex II of the Implementing Regulation Annexes] in relation to each of the goods listed in that Annex
<b>‘Importer’</b>	means either the person lodging a customs declaration for release for free circulation of goods in its own name and on its own behalf or, where the customs declaration is lodged by an indirect customs representative in accordance with Article 18 of Regulation (EU) No 952/2013, the person on whose behalf such a declaration is lodged
<b>‘Importation’</b>	means release for free circulation as provided for in Article 201 of Regulation (EU) No 952/2013
<b>‘Indirect emissions’</b>	means emissions from the production of electricity, which is consumed during the production processes of goods, regardless of the location of the production of the consumed electricity.
<b>‘Inherent CO<sub>2</sub>’</b>	means CO <sub>2</sub> which is part of a source stream.
<b>‘Installation’</b>	means a stationary technical unit where a production process is carried out
<b>‘Measurable heat’</b>	means a net heat flow transported through identifiable pipelines or ducts using a heat transfer medium, such as, in particular, steam, hot air, water, oil, liquid metals and salts, for which a heat meter is or could be installed
<b>‘Measurement point’</b>	means the emission source for which continuous emission measurement systems (CEMS) are used for emission measurement, or the cross-section of a pipeline system for which the CO <sub>2</sub> flow is determined using continuous measurement systems
<b>‘Measurement system’</b>	means a complete set of measuring instruments and other equipment, such as sampling and data processing equipment, used to determine variables such as the activity data, the carbon content, the calorific value or the emission factor of the greenhouse gas emissions
<b>‘Minimum requirements’</b>	means monitoring methods using the minimum efforts allowed for determining data in order to result in emission data acceptable for the purpose of Regulation (EU) 2023/956.
<b>‘Mixed fuel’</b>	means a fuel which contains both biomass and fossil carbon
<b>‘Mixed material’</b>	means a material which contains both biomass and fossil carbon

<b>Term</b>	<b>Definition</b>
<b>‘Net calorific value’ (NCV)</b>	means the specific amount of energy released as heat when a fuel or material undergoes complete combustion with oxygen under standard conditions, less the heat of vaporisation of any water formed
<b>‘Non-measurable heat’</b>	means all heat other than measurable heat
<b>‘Operator’</b>	means any person who operates or controls an installation in a third (i.e. non-EU) country
<b>‘Oxidation factor’</b>	means the ratio of carbon oxidised to CO <sub>2</sub> as a consequence of combustion to the total carbon contained in the fuel, expressed as a fraction, considering carbon monoxide (CO) emitted to the atmosphere as the molar equivalent amount of CO <sub>2</sub>
<b>‘Preliminary emission factor’</b>	means the assumed total emission factor of a fuel or material based on the carbon content of its biomass fraction and its fossil fraction before multiplying it by the fossil fraction to produce the emission factor
<b>‘Power purchase agreement’</b>	means a contract under which a person agrees to purchase electricity directly from an electricity producer
<b>‘Production process’</b>	means the parts of an installation in which chemical or physical processes are carried out to produce goods under an aggregated goods category defined in Table 1 of Section 2 of Annex II, and its specified system boundaries regarding inputs, outputs and corresponding emissions
<b>‘Production route’</b> <sup>156</sup>	means a specific technology used in a production process to produce goods under an aggregated goods category
<b>‘Process emissions’</b>	means greenhouse gas emissions other than combustion emissions occurring as a result of intentional and unintentional reactions between substances or their transformation, for a primary purpose other than the generation of heat, including from the following processes: (a) the chemical, electrolytic or pyrometallurgical reduction of metal compounds in ores, concentrates and secondary materials; (b) the removal of impurities from metals and metal compounds; (c) the decomposition of carbonates, including those used for flue gas cleaning; (d) chemical syntheses of products and intermediate products where the carbon bearing material participates in the reaction; (e) the use of carbon containing additives or raw materials; (f) the chemical or electrolytic reduction of metalloid oxides or non-metal oxides such as silicon oxides and phosphates.

<sup>156</sup> Note that different production routes can fall within the same production process.

<b>Term</b>	<b>Definition</b>
<b>‘Proxy data’</b>	means annual values which are empirically substantiated or derived from accepted sources and which an operator uses to substitute a data set <sup>157</sup> for the purpose of ensuring complete reporting when it is not possible to generate all the required data or factors in the applicable monitoring methodology
<b>‘Rebate’</b>	means any amount that reduces the amount due or paid by a person liable for the payment of a carbon price, before its payment or after, in a monetary form or in any other form.
<b>‘Recommended improvements’</b>	means monitoring methods which are proven means to ensure that data are more accurate or less prone to mistakes than by mere application of minimum requirements, and which may be chosen on a voluntary basis
<b>‘Reporting declarant’</b>	means any of the following persons: <ul style="list-style-type: none"> <li>(a) the importer who lodges a customs declaration for release for free circulation of goods in its own name and on its own behalf;</li> <li>(b) the importerperson, holding an authorisation to lodge a customs declaration referred to in Article 182(1) of Regulation (EU) No 952/2013<sup>1</sup>, who declares the importation of goods;</li> <li>(c) the indirect customs representative, where the customs declaration is lodged by the indirect customs representative appointed in accordance with Article 18 of Regulation (EU) No 952/2013, when the importer is established outside the Union or where the indirect customs representative has agreed to the reporting obligations in accordance with Article 32 of Regulation (EU) 2023/956.</li> </ul>
<b>‘Reporting period’</b>	means a period that the operator of an installation has chosen to use as reference for the determination of embedded emissions
<b>‘Residue’</b>	means a substance that is not the end product(s) that a production process directly seeks to produce; it is not a primary aim of the production process and the process has not been deliberately modified to produce it
<b>‘Simple goods’</b>	means goods produced in a production process requiring exclusively input materials and fuels having zero embedded emissions

<sup>157</sup> Refers to the activity data or the calculation factors.

<b>Term</b>	<b>Definition</b>
<b>‘Source stream’</b>	means any of the following: (a) a specific fuel type, raw material or product giving rise to emissions of relevant greenhouse gases at one or more emission sources as a result of its consumption or production; (b) a specific fuel type, raw material or product containing carbon and included in the calculation of greenhouse gas emissions using a mass-balance method
<b>‘Specific embedded emissions’</b>	means the embedded emissions of one tonne of goods, expressed as tonnes of CO <sub>2</sub> e emissions per tonne of goods
<b>‘Standard conditions’</b>	means temperature of 273,15 K and pressure conditions of 101 325 Pa defining normal cubic metres (Nm <sup>3</sup> )
<b>‘Third country’</b>	means a country or territory outside the customs territory of the European Union
<b>‘Tonne of CO<sub>2</sub>(e)’</b>	means one metric tonne of carbon dioxide (‘CO <sub>2</sub> ’), or an amount of any other greenhouse gas listed in Annex I to the CBAM Regulation with an equivalent global warming potential (‘CO <sub>2</sub> e’)
<b>‘Transmission system operator’</b>	means an operator as defined in Article 2(35) of Directive (EU) 2019/944 of the European Parliament and of the Council ( <sup>158</sup> ).
<b>‘Uncertainty’</b>	means a parameter, associated with the result of the determination of a quantity, that characterises the dispersion of the values that could reasonably be attributed to the particular quantity, including the effects of systematic as well as of random factors, expressed in per cent, and describes a confidence interval around the mean value comprising 95% of inferred values taking into account any asymmetry of the distribution of values
<b>‘Waste’</b>	means any substance or object which the holder discards or intends or is required to discard, excluding substances that have been intentionally modified or contaminated in order to meet this definition
<b>‘Waste gas’</b>	means a gas containing incompletely oxidised carbon in a gaseous state under standard conditions which is a result of any of the processes listed under ‘process emissions’

<sup>158</sup> Directive (EU) 2019/944 of the European Parliament and of the Council of 5 June 2019 on common rules for the internal market for electricity and amending Directive 2012/27/EU (OJ L 158, 14.6.2019, p. 125).

## Annex C                      Default values

Default emission factor values have been produced by the European Commission to allow operators and importers of complex goods to calculate the embedded emissions of precursor goods, that are used as inputs and consumed in the production process for other CBAM goods, where the actual emissions intensities for these precursor goods are not available.

These default values comprise both direct and indirect emissions (where applicable) and are expressed in units of tonnes CO<sub>2e</sub> emissions per tonne of good.

However, default values may only be used in the calculation of embedded emissions for complex goods where precursor emissions contribute **less than 20%** of the **total embedded emissions** of the complex good.

The default values can be found on the European Commission’s dedicated website for the CBAM.

### Taxonomy of CBAM goods and precursor default values

The following sector tables classify CBAM goods and precursors according to their 4-, 6- and 8-digit CN code level. Default values published on the European Commission website follow this hierarchy.

- Default values given at a 4-digit CN code level apply to all goods falling within this 4-digit CN code category.
- Default values supplied at a 6-digit CN code level apply to all goods falling within this 6-digit CN code category.
- Default values supplied at an 8-digit CN code level only apply to this specific 8-digit CN code good – in most case these 8-digit codes are for the steel industry, reflecting the range of different production routes and alloying elements used.

Participants wishing to use default values should note that these are set at a high emissions intensity level, and so in most cases it would be more advantageous to use the actual values for precursor goods where these are available.

*Table 8-1: Default values for iron and steel goods by CN code*

<b>Aggregated good category</b>	<b>Product CN Code</b>	<b>Description</b>	<b>Default value (tCO<sub>2e</sub>/tonne<sup>159</sup>)</b>
<b>Sintered Ore</b>	2601 12 00	Agglomerated iron ores and concentrates, other than roasted iron pyrites	
<b>Pig iron</b>	7201	Pig iron and spiegeleisen in pigs, blocks or other primary forms	

<sup>159</sup> Default values are provided on the European Commission’s dedicated website for the CBAM.

<b>Aggregated good category</b>	<b>Product CN Code</b>	<b>Description</b>	<b>Default value (tCO<sub>2e</sub>/tonne<sup>159</sup>)</b>
	7205 <sup>160</sup>	Some products under 7205 (Granules and powders, of pig iron, spiegeleisen, iron, or steel) may be covered here	
<b>Ferro-alloy: FeMn</b>	7202 1	Ferro-manganese (FeMn)	
<b>Ferro-alloy: FeCr</b>	7202 4	Ferro-chromium (FeCr)	
<b>Ferro-alloy: FeNi</b>	7202 6	Ferro-nickel (FeNi)	
<b>DRI</b>	7203	Ferrous products obtained by direct reduction of iron ore and other spongy ferrous products	
<b>Crude steel</b>	7206	Iron and non-alloy steel in ingots or other primary forms (excluding iron of heading 7203)	
	7206 10 00		
	7206 90 00		
	7207	Semi-finished products of iron or non-alloy steel	
	7207 11 11		
	7207 11 14		
	7207 11 16		
	7207 12 10		
	7207 19 12		
	7207 19 80		
	7207 20 11		
	7207 20 15		
	7207 20 17		
	7207 20 32		
	7207 20 52		
	7207 20 80		
	7207 11 90		
	7207 12 90		
	7207 19 19		

<sup>160</sup> Only some products of this CN code will qualify as “pig iron”, while other goods of this code are classified as “iron or steel products”

<b>Aggregated good category</b>	<b>Product CN Code</b>	<b>Description</b>	<b>Default value (tCO<sub>2</sub>e/tonne<sup>159</sup>)</b>
	7207 20 19		
	7207 20 39		
	7207 20 59		
	7218	Stainless steel in ingots or other primary forms; semi-finished products of stainless steel	
	7218 10 00		
	7218 99 19		
	7218 99 80		
	7218 91		
	7218 99 11		
	7218 99 20		
	7224	Other alloy steel in ingots or other primary forms; semi-finished products of other alloy steel	
	7224 10		
	7224 90 18		
	7224 90 90		
	7224 90 02		
	7224 90 03		
	7224 90 05		
	7224 90 07		
	7224 90 14		
	7224 90 31		
	7224 90 38		
<b>Iron or steel products</b>	7205	Granules and powders, of pig iron, spiegeleisen, iron or steel (if not covered under category pig iron)	
	7208	Flat-rolled products of iron or non-alloy steel, of a width of 600 mm or more, hot-rolled, not clad, plated or coated	
	7209	Flat-rolled products of iron or non-alloy steel, of a width of 600 mm or more, cold-rolled (cold-reduced), not clad, plated or coated	



<b>Aggregated good category</b>	<b>Product CN Code</b>	<b>Description</b>	<b>Default value (tCO<sub>2</sub>e/tonne<sup>159</sup>)</b>
	7210	Flat-rolled products of iron or non-alloy steel, of a width of 600 mm or more, clad, plated or coated	
	7211	Flat-rolled products of iron or non-alloy steel, of a width of less than 600 mm, not clad, plated or coated	
	7212	Flat-rolled products of iron or non-alloy steel, of a width of less than 600 mm, clad, plated or coated	
	7213	Bars and rods, hot-rolled, in irregularly wound coils, of iron or non-alloy steel	
	7214	Other bars and rods of iron or non-alloy steel, not further worked than forged, hot-rolled, hot-drawn or hot-extruded, but including those twisted after rolling	
	7215	Other bars and rods of iron or non-alloy steel	
	7216	Angles, shapes and sections of iron or non-alloy steel	
	7217	Wire of iron or non-alloy steel	
	7219	Flat-rolled products of stainless steel, of a width of 600 mm or more	
	7220	Flat-rolled products of stainless steel, of a width of less than 600 mm	
	7221	Bars and rods, hot-rolled, in irregularly wound coils, of stainless steel	
	7222	Other bars and rods of stainless steel; angles, shapes and sections of stainless steel	
	7223	Wire of stainless steel	
	7225	Flat-rolled products of other alloy steel, of a width of 600 mm or more	

<b>Aggregated good category</b>	<b>Product CN Code</b>	<b>Description</b>	<b>Default value (tCO<sub>2</sub>e/tonne<sup>159</sup>)</b>
	7226	Flat-rolled products of other alloy steel, of a width of less than 600 mm	
	7227	Bars and rods, hot-rolled, in irregularly wound coils, of other alloy steel	
	7228	Other bars and rods of other alloy steel; angles, shapes and sections, of other alloy steel; hollow drill bars and rods, of alloy or non-alloy steel	
	7229	Wire of other alloy steel	
	7301	Sheet piling of iron or steel, whether or not drilled, punched or made from assembled elements; welded angles, shapes and sections, of iron or steel	
	7302	Railway or tramway track construction material of iron or steel, the following: rails, check-rails and rack rails, switch blades, crossing frogs, point rods and other crossing pieces, sleepers (cross-ties), fish-plates, chairs, chair wedges, sole plates (base plates), rail clips, bedplates, ties and other material specialised for jointing or fixing rails	
	7303	Tubes, pipes and hollow profiles, of cast iron	
	7304	Tubes, pipes and hollow profiles, seamless, of iron (other than cast iron) or steel	
	7305	Other tubes and pipes (for example, welded, riveted or similarly closed), having circular cross-sections, the external diameter of which exceeds 406,4 mm, of iron or steel	
	7306	Other tubes, pipes and hollow profiles (for example, open seam or welded, riveted or similarly closed), of iron or steel	

<b>Aggregated good category</b>	<b>Product CN Code</b>	<b>Description</b>	<b>Default value (tCO<sub>2</sub>e/tonne<sup>159</sup>)</b>
	7307	Tube or pipe fittings (for example, couplings, elbows, sleeves), of iron or steel	
	7308	Structures (excluding prefabricated buildings of heading 9406) and parts of structures (for example, bridges and bridge-sections, lock-gates, towers, lattice masts, roofs, roofing frameworks, doors and windows and their frames and thresholds for doors, shutters, balustrades, pillars and columns), of iron or steel; plates, rods, angles, shapes, sections, tubes and the like, prepared for use in structures, of iron or steel	
	7309	Reservoirs, tanks, vats and similar containers for any material (other than compressed or liquefied gas), of iron or steel, of a capacity exceeding 300 l, whether or not lined or heat-insulated, but not fitted with mechanical or thermal equipment	
	7310	Tanks, casks, drums, cans, boxes and similar containers, for any material (other than compressed or liquefied gas), of iron or steel, of a capacity not exceeding 300 l, whether or not lined or heat-insulated, but not fitted with mechanical or thermal equipment	
	7311	Containers for compressed or liquefied gas, of iron or steel	
	7318	Screws, bolts, nuts, coach screws, screw hooks, rivets, cotters, cotter pins, washers (including spring washers) and similar articles, of iron or steel	
	7326	Other articles of iron or steel	

Table 8-2 Default values for cement goods by CN code

<b>Aggregated good category</b>	<b>Product CN Code</b>	<b>Description</b>	<b>Default value (tCO<sub>2e</sub>/tonne)</b>
<b>Calcined clay</b>	2507 00 80	Kaolin and other kaolinic clays, calcined	
<b>Cement clinker</b>	2523 10 00	Cement clinkers	
<b>Cement</b>	2523 21 00	White Portland cement, whether or not artificially coloured	
	2523 29 00	Other Portland cement	
	2523 90 00	Other hydraulic cements	
<b>Aluminous cement</b>	2523 30 00	Aluminous cement <sup>161</sup>	

Table 8-3 Default values for fertilizer goods by CN code

<b>Aggregated good category</b>	<b>Product CN Code</b>	<b>Description</b>	<b>Default value (tCO<sub>2e</sub>/tonne)</b>
<b>Nitric acid</b>	2808 00 00	Nitric acid; sulphonitric acids	
<b>Urea</b>	3102 10	Urea, whether or not in aqueous solution	
<b>Ammonia</b>	2814	Ammonia, anhydrous or in aqueous solution	
<b>Mixed fertilizers</b>	2834 21 00	Nitrates of potassium	
	3102	Mineral or chemical fertilizers, nitrogenous, except 3102 10 (Urea)	
	3102 21 00	Ammonium sulphate	
	3102 29 00	Double salts and mixtures of ammonium sulphate and ammonium nitrate	
	3102 30	Ammonium nitrate, whether or not in aqueous solution	
	3102 40	Mixtures of ammonium nitrate with calcium carbonate or other inorganic non-fertilizing substances.	
	3102 50 00	Sodium nitrate	

<sup>161</sup> Also referred to as 'Calcium Aluminate Cement'.

<b>Aggregated good category</b>	<b>Product CN Code</b>	<b>Description</b>	<b>Default value (tCO<sub>2</sub>e/tonne</b>
	3102 60 00	Double salts and mixtures of calcium nitrate and ammonium nitrate	
	3102 80 00	Mixtures of urea and ammonium nitrate in aqueous or ammoniacal solution	
	3105 <sup>162</sup>	Mineral or chemical fertilizers containing two or three of the fertilizing elements nitrogen, phosphorus and potassium; other fertilizers  - Except: 3105 60 00 – Mineral or chemical fertilizers containing the two fertilising elements phosphorus and potassium	
	3105 20	Mineral or chemical fertilizers containing the three fertilising elements nitrogen, phosphorus and potassium  - Except: 3105 60 00 – Mineral or chemical fertilizers containing the two fertilising elements phosphorus and potassium	
	3105 30 00	Diammonium hydrogenorthophosphate (diammonium phosphate)	
	3105 40 00	Ammonium dihydrogenorthophosphate (monoammonium phosphate) and mixtures thereof with diammonium hydrogenorthophosphate (diammonium phosphate)	
	3105 51 00	Containing nitrates and phosphates	

<sup>162</sup> Except 3105 60 00 – Mineral or chemical fertilizers containing the two fertilising elements phosphorus and potassium. Excluded as not nitrogenous. Only nitrogen (N) containing fertilizers have significant embedded emissions.

<b>Aggregated good category</b>	<b>Product CN Code</b>	<b>Description</b>	<b>Default value (tCO<sub>2</sub>e/tonne)</b>
	3105 59 00	Mineral or chemical fertilizers containing the two fertilizing elements nitrogen (excl. nitrate) and phosphorus but not nitrates (excl. ammonium dihydrogenorthophosphate "monoammonium phosphate", diammonium hydrogenorthophosphate "diammonium phosphate")	

Table 8-4 Default values for aluminium goods by CN code

<b>Aggregated good category</b>	<b>Product CN Code</b>	<b>Description</b>	<b>Default value (tCO<sub>2</sub>e/tonne)</b>
<b>Unwrought aluminium</b>	7601	Unwrought aluminium	
<b>Aluminium products</b>	7603	Aluminium powders and flakes	
	7604	Aluminium bars, rods and profiles	
	7604 10 10	Aluminium bars, rods, not alloyed	
	7604 10 90	Aluminium profiles, not alloyed	
	7604 21 00	Aluminium alloy hollow profiles	
	7604 29 10	Aluminium alloy bars, rods	
	7604 29 90	Aluminium alloy profiles	
	7605	Aluminium wire	
	7606	Aluminium plates, sheets and strip, of a thickness exceeding 0,2 mm	
	7607	Aluminium foil (whether or not printed or backed with paper, paper-board, plastics or similar backing materials) of a thickness (excluding any backing) not exceeding 0,2 mm	
7608	Aluminium tubes and pipes		

<b>Aggregated good category</b>	<b>Product CN Code</b>	<b>Description</b>	<b>Default value (tCO<sub>2</sub>e/tonne)</b>
	7609 00 00	Aluminium tube or pipe fittings (for example, couplings, elbows, sleeves)	
	7610	Aluminium structures (excluding prefabricated buildings of heading 9406) and parts of structures (for example, bridges and bridge-sections, towers, lattice masts, roofs, roofing frameworks, doors and windows and their frames and thresholds for doors, balustrades, pillars and columns); aluminium plates, rods, profiles, tubes and the like, prepared for use in structures	
	7610 10 00	Doors, windows and their frames and thresholds for doors	
	7610 90	Other structures and parts of structures, of aluminium	
	7610 90 10	Bridges and bridge-sections, towers and lattice masts	
	7610 90 90	Structures and parts of structures, of aluminium	
	7611 00 00	Aluminium reservoirs, tanks, vats and similar containers, for any material (other than compressed or liquefied gas), of a capacity exceeding 300 litres, whether or not lined or heat-insulated, but not fitted with mechanical or thermal equipment	
	7612	Aluminium casks, drums, cans, boxes and similar containers (including rigid or collapsible tubular containers), for any material (other than compressed or liquefied gas), of a capacity not exceeding 300 litres, whether or not lined or heat-insulated, but not fitted with mechanical or thermal equipment	
	7613 00 00	Aluminium containers for compressed or liquefied gas	

<b>Aggregated good category</b>	<b>Product CN Code</b>	<b>Description</b>	<b>Default value (tCO<sub>2</sub>e/tonne)</b>
	7614	Stranded aluminium wire, cables, plaited bands and the like, of aluminium, not electrically insulated	
	7616	Other articles of aluminium	
	7616 10 00	Nails, tacks, staples, screws, bolts, nuts, screw hooks, rivets, cotters, cotter pins, washers and similar articles	
	7616 91 00	Cloth, grill, netting and fencing, of aluminium wire	
	7616 99 10	Other cast articles of aluminium	
	7616 99 90	Other uncast articles of aluminium	



## Annex D – Further information on biomass

As has been explained in section 6.5.4, emissions from biomass may be “zero-rated” only if certain of **sustainability and GHG savings criteria** (which are summarised as “**RED II criteria**” are complied with. These are defined in the “RED II” (re-cast Renewable Energy Directive<sup>163</sup>). This Annex provides further practical advice on the practical application of these criteria.

*The following short introduction to the sustainability and GHG savings criteria is based on the Commission’s Guidance Document No.3 “Biomass issues in the EU ETS”.  
[https://climate.ec.europa.eu/system/files/2022-10/gd3\\_biomass\\_issues\\_en.pdf](https://climate.ec.europa.eu/system/files/2022-10/gd3_biomass_issues_en.pdf)*

### 1. Definitions

For easier understanding of the text below, the following definitions will be useful:

- ‘Biofuels’ means liquid fuels for transport produced from biomass;
- ‘Bioliquids’ means liquid fuel for energy purposes other than for transport, including electricity and heating and cooling, produced from biomass;
- ‘Biomass fuels’ means gaseous and solid fuels produced from biomass;
- ‘Biogas’ means gaseous fuels produced from biomass;
- ‘Waste’ means any substance or object which the holder discards or intends or is required to discard, excluding substances that have been intentionally modified or contaminated in order to meet this definition;
- ‘Residue’ means a substance that is not the end product(s) that a production process directly seeks to produce; it is not a primary aim of the production process and the process has not been deliberately modified to produce it;
- ‘Agricultural, aquaculture, fisheries and forestry residues’ means residues that are directly generated by agriculture, aquaculture, fisheries and forestry and that do not include residues from related industries or processing;
- ‘Municipal waste’ means: (a) mixed waste and separately collected waste from households, including paper and cardboard, glass, metals, plastics, bio- waste, wood, textiles, packaging, waste electrical and electronic equipment, waste batteries and accumulators, and bulky waste, including mattresses and furniture; (b) mixed waste and separately collected waste from other sources, where such waste is similar in nature and composition to waste from households; Municipal waste does not include waste from production, agriculture, forestry, fishing, septic tanks and sewage network and treatment, including sewage sludge, end-of-life vehicles or construction and demolition waste.

---

<sup>163</sup> Directive (EU) 2018/2001, on the promotion of the use of energy from renewable sources (recast). See: <http://data.europa.eu/eli/dir/2018/2001/2022-06-07>

## 2. Which criteria apply?

Figure 8-1 presents a “decision tree” to which an operator may adhere in order to determine which written procedures have to be included in the MMD, and to determine the emission factor of biomass. The numbered steps in this picture mean the following:

1. The first step is to determine if the source stream consists exclusively of biomass, or whether it is mixed with a fossil fraction. In the latter case, the relevant analyses of the biomass fraction or the application of a reasonable default value is necessary (see last sub-heading in section 6.5.1.4). The possibility to apply an emission factor of zero applies only to the biomass fraction of the source stream.

The biomass fraction might also be determined based on proofs of sustainability from a certification scheme.

If only a part of the source stream is biomass, the following steps apply only to that biomass fraction. However, if the necessary evidence for meeting the RED II criteria is available only for a part of that biomass fraction, there are three fractions (one fossil, one biomass part that is treated like being fossil, and a biomass part which is zero-rated because it fulfils the RED II criteria).

2. Determine if the source stream is used (primarily) for energy purposes. Only if this is the case, the following steps are needed.
3. If the source stream is municipal solid waste, no further criteria need to be taken into account. The biomass fraction may be zero-rated.
4. Determine if the source stream is any type of forest or agricultural biomass, or (produced from) “residues from agriculture, aquaculture, fisheries or forestry”, as for such source streams the “land-related” sustainability criteria<sup>164</sup> apply. For other residues or waste (including all kinds of industrial wastes, if containing biomass), only GHG savings criteria need to be complied with<sup>165</sup>.

Note, however, that for biomass stemming from residues from animals, aquaculture and fisheries, the RED II does not list specific land-related sustainability criteria. For such materials operators will have to determine only GHG savings. Therefore, go to step 7.

5. Depending on step 4, the (land-related) sustainability criteria for the production of biofuels, bioliquids or biomass fuel are to be assessed. In short, the operator can rely on the certification of the used material/fuel under an (international) voluntary scheme recognised by the Commission.

---

<sup>164</sup> Article 29(2) to (7) of RED II

<sup>165</sup> In line with the methodology given in the Annexes of the RED II, “no emissions shall be allocated to wastes and residues” [at the first point of collection] when calculating life cycle emissions and GHG savings. This means effectively that for waste of biological origin which is generated directly at the [CBAM] installation, the GHG savings criteria will usually be fulfilled, and this will be easily demonstrated.

The tricky point here is to determine if a material is indeed waste, or whether it is a product, by-product or residue from a production process. For this, the definition of “waste” as given at the start of this Annex should be applied. It excludes explicitly “substances that have been intentionally modified or contaminated in order to meet this definition”. A case-by-case assessment may be required. Some RED II certification schemes may give support by providing confirmation if a material is to be considered waste.

Figure 8-1: Decision tree for applying sustainability and GHG saving criteria of the RED II to the monitoring of EU ETS source streams.

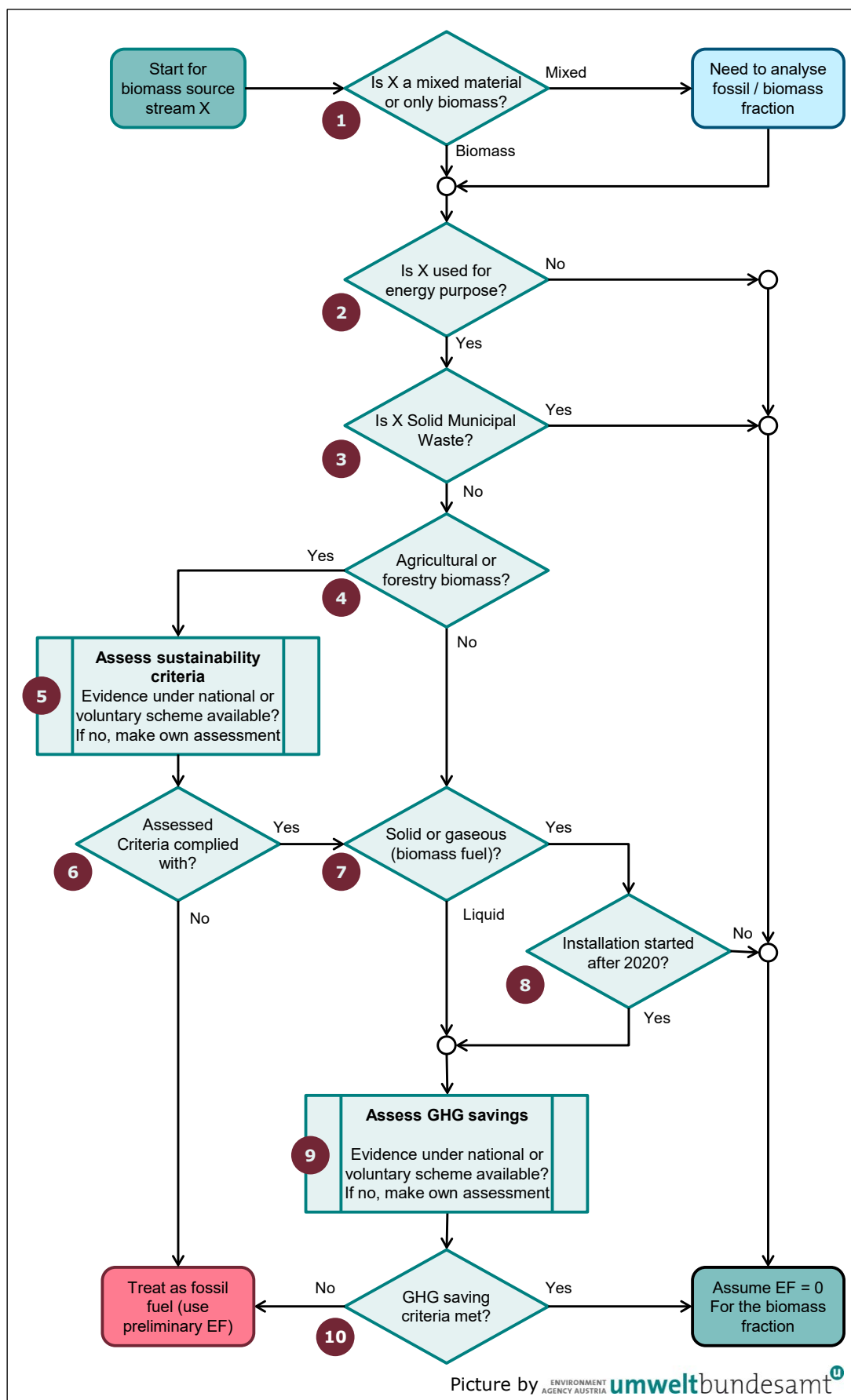

If no proof of sustainability under a certification scheme is available to the operator, the operator would have to perform the assessment of the relevant criteria itself. More details on steps 4 and 5 are given in sections 3.1 and 3.2 of this Annex.

6. If the previous step shows that the relevant sustainability criteria are not complied with, then the operator has to treat the material as if it were fossil, i.e. the preliminary emission factor becomes the emission factor.
7. If the source stream is liquid, the assessment of GHG savings is mandatory. Go to step 9.
8. As the additional requirement for “biomass fuels”, i.e. solid or gaseous biomass, applies only to installations starting operation from 1 January 2021, older installations (more exactly: installations which used biomass already before 2021) do not have to carry out further assessment.
9. The required GHG savings<sup>166</sup> have to be calculated in accordance with the outline given in section 3.2 of this Annex.
10. If the GHG savings are above the applicable threshold, the biomass can be zero-rated, otherwise it has to be treated as if it were fossil. With this step, the assessment is finished.

### 3. How to provide evidence for RED II criteria

This section explains how compliance against RED II criteria is checked. While these checks are usually performed under a certification scheme, the same considerations are relevant for operators who want to demonstrate compliance with RED II criteria without use of a certification scheme.

Depending on the needs identified using the “decision tree” (section 2 of this Annex), either sustainability criteria, GHG savings criteria, or both or none of these apply. It is therefore possible to discuss sustainability criteria (section 3.1 of this Annex) and GHG savings criteria (section 3.2 of this Annex) separately. Furthermore, the operator will have to ensure completeness of information by using a mass balance as required by Article 30(1) of the RED II, which is necessary to ensure that all criteria are tracked without gaps or double counting throughout the full chain of custody from the first collection point (harvest of biomass) to the use in the installation.

**For more details, please refer to the legal text of the RED II.** The aim of the following sections is meant only as a short overview for orientation in the RED II. Furthermore, an implementing act on “*rules to verify sustainability and greenhouse gas emissions saving criteria and low indirect land-use change-risk criteria*” gives detailed guidance<sup>167</sup>. This implementing act also gives the framework with which voluntary certification schemes have to comply.

---

<sup>166</sup> Article 29(10) of the RED II requires that GHG savings have to be calculated in accordance with Article 31(1) of the RED II.

<sup>167</sup> Commission Implementing Regulation (EU) 2022/996 on rules to verify sustainability and greenhouse gas emissions saving criteria [...], [http://data.europa.eu/eli/reg\\_impl/2022/996/oj](http://data.europa.eu/eli/reg_impl/2022/996/oj)



### 3.1 Sustainability criteria

The sustainability criteria are defined in Articles 29(2) to (7) of RED II. They can be summarised as follows:

- Biofuels, bioliquids and biomass fuels produced from residues derived from **agricultural land** (not from forestry) must comply with the conditions laid down in Article 29(2) of the RED II:  
“Operators or national authorities [must] have monitoring or management plans in place in order to address the impacts on soil quality and soil carbon.”
- Biofuels, bioliquids and biomass fuels produced from agricultural biomass (this includes the main product of that land, as well as residues) must comply with all of the following paragraphs of Article 29 of the RED II:
  - Article 29(3) excludes raw material obtained from land with a high biodiversity value, namely land that had a specified status in or after January 2008, whether or not the land continues to have that status. Relevant statuses listed are (a) primary forest and similar, (b) highly biodiverse forest and similar, (c) areas that are nature protected, and (d) highly biodiverse grassland. For Point (d), further criteria are given in an implementing act<sup>168</sup>.
  - Article 29(4) prevents the use of land which was converted from land with high carbon stocks, namely land that had a specified status in or after January 2008 and no longer has that status, in particular wetland and continuously forested areas.
  - Article 29(5) excludes biomass from former peatland, except if evidence is provided that no drainage of previously undrained soil is involved.
- Biofuels, bioliquids and biomass fuels produced from **forest biomass** (including residues from forestry) must meet certain criteria to minimise the risk of using forest biomass derived from unsustainable production (RED II Article 29(6)), and must meet specified land-use, land-use change and forestry (LULUCF) criteria given by Article 29(7). An implementing act<sup>169</sup> provides further guidance.
- For other biomass (e.g. animal waste or by-products; products, wastes or residues from aquaculture and fisheries; biomass from microorganisms, e.g. from industrial fermentation, etc.), no sustainability criteria are defined in the RED II. Therefore, no further assessments for these types of biomass are relevant. However, it will be useful for an operator to have evidence available that the source stream under discussion indeed falls within this category, i.e. it is a waste and not a material intentionally modified or contaminated in order to become waste. Some certification schemes

---

<sup>168</sup> Commission Regulation (EU) No 1307/2014 on defining the criteria and geographic ranges of highly biodiverse grassland. See <http://data.europa.eu/eli/reg/2014/1307/oj>

<sup>169</sup> Commission Implementing Regulation (EU) 2022/2448 on establishing operational guidance on the evidence for demonstrating compliance with the sustainability criteria for forest biomass: [http://data.europa.eu/eli/reg\\_impl/2022/2448/oj](http://data.europa.eu/eli/reg_impl/2022/2448/oj)

might provide the classification as part of their services, but this should only be necessary for borderline cases.

### 3.2 GHG savings

When the RED II requires GHG savings to be demonstrated, it means that the energy produced from biomass must lead to lower **life cycle emissions** than the use of comparable fossil fuels. The methodology for calculating GHG savings from biofuels and bioliquids is given in section C of Annex V to the RED II. For biomass fuels (biogas and solid biomass), the methodology is given in section B of Annex VI to the RED II. A short summary of the methodology is given here:

**Step 1:** Calculate the emissions  $E$  from the biomass use using the formula:

$$E = e_{ec} + e_l + e_p + e_{td} + e_u - e_{sca} - e_{ccs} - e_{ccr}$$

Where

$e_{ec}$  = emissions from the extraction or cultivation of raw materials<sup>170</sup>;

$e_l$  = annualised emissions from carbon stock changes caused by land-use change;

$e_p$  = emissions from processing;

$e_{td}$  = emissions from transport and distribution;

$e_u$  = emissions from the fuel in use<sup>171</sup>;

$e_{sca}$  = emission savings from soil carbon accumulation via improved agricultural management;

$e_{ccs}$  = emission savings from CO<sub>2</sub> capture and geological storage;

$e_{ccr}$  = emission savings from CO<sub>2</sub> capture and replacement.

For  $e_{ec}$ ,  $e_p$  and  $e_{td}$ , Annexes V and VI provide typical and default values for many feedstock types and processes for biofuel and biomass fuel production. In the case of solid biomass, transport emissions are given dependent of transport distance.

Installations often consume several types of waste materials or residues for which no default values can be found in the RED II. As a simplifying assumption, life cycle emissions of waste at the place and time when the material starts to comply with the definition of waste may be considered zero, if the emissions of sourcing (cultivation, transport to upstream processing, and that processing itself) can be reasonably attributed to the main products instead of the waste. Therefore, for such wastes, only the transport

---

<sup>170</sup> Default emission factors at regional (NUTS2) level are available from the Commission's website [https://energy.ec.europa.eu/topics/renewable-energy/biofuels/biofuels\\_en](https://energy.ec.europa.eu/topics/renewable-energy/biofuels/biofuels_en) and [https://energy.ec.europa.eu/system/files/2018-07/pre-iluc\\_directive\\_nuts2\\_report\\_values\\_mj\\_kg\\_july\\_2018\\_0.pdf](https://energy.ec.europa.eu/system/files/2018-07/pre-iluc_directive_nuts2_report_values_mj_kg_july_2018_0.pdf)

<sup>171</sup> Annexes V and VI of the RED II clarify: "Emissions of the fuel in use,  $e_u$ , shall be taken to be zero for **biofuels and bioliquids**. Emissions of non-CO<sub>2</sub> greenhouse gases (N<sub>2</sub>O and CH<sub>4</sub>) of the fuel in use shall be included in the  $e_u$  factor for bioliquids. Emissions of CO<sub>2</sub> from fuel in use,  $e_u$ , shall be taken to be zero for **biomass fuels**. Emissions of non-CO<sub>2</sub> greenhouse gases (CH<sub>4</sub> and N<sub>2</sub>O) from the fuel in use shall be included in the  $e_u$  factor."

emissions up to the installation (if any) as well as potential emissions from processing before combustion (if any) in the installation would have to be taken into account for determining their life cycle emissions.

For  $e_u$  the methodology in the RED II also gives instructions how the production of heat and electricity is to be handled if produced separately or by CHP<sup>172</sup>. Note that the approach to taking into account CHP is different from the approach used in the CBAM<sup>173</sup>.

$e_{sca}$  may only be taken into account if solid and verifiable evidence is provided.  $e_{ccs}$  and  $e_{ccr}$  are only relevant if CCS/CCU are applied.

Greenhouse gases to be taken into account and their GWP<sup>174</sup> values are CO<sub>2</sub>, N<sub>2</sub>O (GWP=298), CH<sub>4</sub> (GWP=25).

Where a proof of sustainability from a certification scheme is available at least for some parts of the value chain, the relevant  $e$  values for the formula above should be available from that proof. Also the GHG savings as calculated below should be given.

**Step 2:** Calculate the GHG savings as follows:

- For the use of (transport) biofuels:

$$SAVING = (E_{F(t)} - E_{B(t)}) / E_{F(t)}$$

Where:

$E_B$  = total emissions from the biofuel;

$E_F$  = total emissions from the fossil fuel comparator

- For the production of heating (and cooling) and electricity:

$$SAVING = (EC_{F(h\&c,el)} - EC_{B(h\&c,el)}) / EC_{F(h\&c,el)}$$

Where:

$EC_{B(h\&c,el)}$  = total emissions from the biomass fuel or bioliquid;

$EC_{F(h\&c,el)}$  = total emissions from the fossil fuel comparator for heating, cooling or electricity, as applicable

The generation efficiency  $\eta$  for heating, cooling or electricity has to be taken into account as follows:

$$EC = E / \eta$$

---

<sup>172</sup> Combined Heat and Power (Cogeneration)

<sup>173</sup> Section 6.7.4 of this guidance document

<sup>174</sup> GWP means the Global Warming Potential. Unfortunately, the GWP values given in the RED II have not yet been updated to those of the IPCC's 5<sup>th</sup> Assessment Report, which are used by the MRR. However, an update of these values by the Commission at a later stage is possible.

The following fossil fuel comparators apply<sup>175</sup>:

Purpose	Value of the fossil fuel comparator
Transport fuels (liquid): $E_{F(l)}$	94 g CO <sub>2</sub> e/MJ
Production of electricity: $EC_{F(el)}$	183 g CO <sub>2</sub> e/MJ
Production of useful heat, and heating and/or cooling: $EC_{F(h\&c)}$	80 g CO <sub>2</sub> e/MJ

In installations, “useful heat” can mean both, measurable and non-measurable heat. When measurable heat is generated, an efficiency for heat generation from the fuel is known (or can be at least determined in principle). The fossil fuel comparator takes such efficiency into account. For non-measurable heat, however, a fictitious heat generation efficiency of  $\eta = 90\%$  needs to be applied for making the amount of fuel used compatible with the comparator.

Secondly, if both, heat and electricity are produced in the installation, the respective fuel quantities have to be checked against the respective fossil fuel comparators separately. If a certification scheme is used, the economic operator (which may be the installation’s operator) doing the calculation must take the information on the efficiency of heat and electricity generation into account appropriately.

**Step 3:** Compare the GHG savings to the criteria given in Article 29(10) of the RED II:

- For **biofuels, biogas consumed in the transport sector and bioliquids**, savings must be at least 50% if produced<sup>176</sup> in installations in operation before 5 October 2015, at least 60% for installations starting operation until 31 December 2020, and at least 65% for installations starting operation from 1 January 2021. However, this calculation is usually performed by the producer of the biofuel, not by installations consuming such bioliquid or biogas. However, if an installation also uses diverse liquid biomass wastes or biogas<sup>176</sup>, it may consider itself to be the producer of the bioliquid or biogas. In such case, the GHG savings calculation may have to be performed by the operator of the installation, or by a certification scheme on its behalf.
- For **biomass fuels (i.e. solid and gaseous biomass)** consumed in installations, GHG savings must be
  - at least 70% in installations starting operation from 1 January 2021 until 31 December 2025,
  - 80% for installations starting operation from 1 January 2026.

<sup>175</sup> For liquid transport fuels, the comparator refers to the energy content of the fuel (NCV), while for the production of heat and electricity, the comparator refers to the amount of heat / electricity produced (taking into account the CHP calculation, where relevant).

<sup>176</sup> This criterion is relevant if the installation produces these fuels and delivers them to other users who have to provide proof for RED II compliance, but also if the installation consumes these fuels itself. Regarding biogas, the “for transport” purpose would then not be given. Instead, the criterion for biomass fuels in the next bullet point would apply.



## Annex E – Standard values for emission calculations

Implementing Regulation: Annex VIII

Standard factors used in the monitoring of direct emissions at installation level

### Fuel emission factors related to net calorific values (NCV)

Table 8-5: Fuel emission factors related to net calorific value (NCV) and net calorific values per mass of fuel.

Fuel type description	Emission factor (t CO <sub>2</sub> /TJ)	Net calorific value (TJ/Gg)	Source
Crude oil	73,3	42,3	IPCC 2006 GL
Orimulsion	77,0	27,5	IPCC 2006 GL
Natural gas liquids	64,2	44,2	IPCC 2006 GL
Motor gasoline	69,3	44,3	IPCC 2006 GL
Kerosene (other than jet kerosene)	71,9	43,8	IPCC 2006 GL
Shale oil	73,3	38,1	IPCC 2006 GL
Gas/Diesel oil	74,1	43,0	IPCC 2006 GL
Residual fuel oil	77,4	40,4	IPCC 2006 GL
Liquefied petroleum gases	63,1	47,3	IPCC 2006 GL
Ethane	61,6	46,4	IPCC 2006 GL
Naphtha	73,3	44,5	IPCC 2006 GL
Bitumen	80,7	40,2	IPCC 2006 GL
Lubricants	73,3	40,2	IPCC 2006 GL
Petroleum coke	97,5	32,5	IPCC 2006 GL
Refinery feedstocks	73,3	43,0	IPCC 2006 GL
Refinery gas	57,6	49,5	IPCC 2006 GL
Paraffin waxes	73,3	40,2	IPCC 2006 GL
White spirit and SBP	73,3	40,2	IPCC 2006 GL
Other petroleum products	73,3	40,2	IPCC 2006 GL
Anthracite	98,3	26,7	IPCC 2006 GL
Coking coal	94,6	28,2	IPCC 2006 GL
Other bituminous coal	94,6	25,8	IPCC 2006 GL
Sub-bituminous coal	96,1	18,9	IPCC 2006 GL
Lignite	101,0	11,9	IPCC 2006 GL
Oil shale and tar sands	107,0	8,9	IPCC 2006 GL
Patent fuel	97,5	20,7	IPCC 2006 GL
Coke oven coke and lignite coke	107,0	28,2	IPCC 2006 GL
Gas coke	107,0	28,2	IPCC 2006 GL
Coal tar	80,7	28,0	IPCC 2006 GL
Gas works gas	44,4	38,7	IPCC 2006 GL
Coke oven gas	44,4	38,7	IPCC 2006 GL
Blast furnace gas	260	2,47	IPCC 2006 GL
Oxygen steel furnace gas	182	7,06	IPCC 2006 GL
Natural gas	56,1	48,0	IPCC 2006 GL
Industrial wastes	143	n.a.	IPCC 2006 GL
Waste oils	73,3	40,2	IPCC 2006 GL
Peat	106,0	9,76	IPCC 2006 GL
Waste tyres	85,0 <sup>(177)</sup>	n.a.	WBCSD CSI
Carbon monoxide	155,2 <sup>(178)</sup>	10,1	J. Falbe and M. Regitz, Römpf Chemie Lexikon, Stuttgart, 1995
Methane	54,9 <sup>(179)</sup>	50,0	J. Falbe and M. Regitz, Römpf Chemie Lexikon, Stuttgart, 1995

<sup>(177)</sup> This value is the preliminary emission factor, i.e., before application of a biomass fraction, if applicable.

<sup>(178)</sup> Based on NCV of 10,12 TJ/t.

<sup>(179)</sup> Based on NCV of 50,01 TJ/t.

Table 8-6: Fuel emission factors related to net calorific value (NCV) and net calorific values per mass of biomass material.

Biomass material	Preliminary EF [t CO <sub>2</sub> / TJ]	NCV [GJ/t]	Source
Wood / Wood waste (air dry <sup>(180)</sup> )	112	15,6	IPCC 2006 GL
Sulphite lyes (black liquor)	95,3	11,8	IPCC 2006 GL
Other primary solid biomass	100	11,6	IPCC 2006 GL
Charcoal	112	29,5	IPCC 2006 GL
Bio gasoline	70,8	27,0	IPCC 2006 GL
Biodiesels	70,8	37,0	IPCC 2006 GL <sup>(181)</sup>
Other liquid biofuels	79,6	27,4	IPCC 2006 GL
Landfill gas <sup>(182)</sup>	54,6	50,4	IPCC 2006 GL
Sludge gas <sup>(10)</sup>	54,6	50,4	IPCC 2006 GL
Other biogas <sup>(10)</sup>	54,6	50,4	IPCC 2006 GL
Municipal waste (biomass fraction) <sup>(183)</sup>	100	11,6	IPCC 2006 GL

### Emission factors related to process emissions

Table 8-7: Stoichiometric emission factor for process emissions from carbonate decomposition (Method A)

Carbonate	Emission factor [t CO <sub>2</sub> / t Carbonate]
CaCO <sub>3</sub>	0,440
MgCO <sub>3</sub>	0,522
Na <sub>2</sub> CO <sub>3</sub>	0,415
BaCO <sub>3</sub>	0,223
Li <sub>2</sub> CO <sub>3</sub>	0,596
K <sub>2</sub> CO <sub>3</sub>	0,318
SrCO <sub>3</sub>	0,298
NaHCO <sub>3</sub>	0,524
FeCO <sub>3</sub>	0,380

<sup>(180)</sup> The given emission factor assumes around 15% water content of the wood. Fresh wood can have water content of up to 50%. For determining the NCV of completely dry wood, the following equation shall be used:

$$NCV = NCV_{dry} \cdot (1 - w) - \Delta H_v \cdot w$$

Where  $NCV_{dry}$  is the NCV of the absolute dry material,  $w$  is the water content (mass fraction) and  $\Delta H_v = 2,4 \text{ GJ/t } H_2O$  is the evaporation enthalpy of water. Using the same equation, the NCV for a given water content can be back-calculated from the dry NCV.

<sup>(181)</sup> The NCV value is taken from Annex III of Directive (EU) 2018/2001.

<sup>(182)</sup> For landfill gas, sludge gas and other biogas: Standard values refer to pure Biomethane. For arriving at the correct standard values, a correction is required for the methane content of the gas.

<sup>(183)</sup> The IPCC guidelines also give values for the fossil fraction of municipal waste: EF = 91,7 t CO<sub>2</sub>/TJ; NCV = 10 GJ/t

Carbonate	Emission factor [t CO <sub>2</sub> / t Carbonate]
General	$\text{Emission factor} = \frac{M(\text{CO}_2)}{Y * [M(x)] + Z * [M(\text{CO}_3^{2-})]}$ <p> X = metal  M(x) = molecular weight of X in [g/mol]  M(CO<sub>2</sub>) = molecular weight of CO<sub>2</sub> in [g/mol]  M(CO<sub>3</sub><sup>2-</sup>) = molecular weight of CO<sub>3</sub><sup>2-</sup> in [g/mol]  Y = stoichiometric number of X  Z = stoichiometric number of CO<sub>3</sub><sup>2-</sup> </p>

Table 8-8: Stoichiometric emission factor for process emissions from carbonate decomposition based on alkali earth oxides (Method B)

Oxide	Emission factor [t CO <sub>2</sub> / t Oxide]
CaO	0,785
MgO	1,092
BaO	0,287
general: X <sub>Y</sub> O <sub>Z</sub>	$\text{Emission factor} = \frac{M(\text{CO}_2)}{Y * [M(x)] + Z * [M(\text{O})]}$ <p> X = alkali earth or alkali metal  M(x) = molecular weight of X in [g/mol]  M(CO<sub>2</sub>) = molecular weight of CO<sub>2</sub> [g/mol]  M(O) = molecular weight of O [g/mol]  Y = stoichiometric number of X  = 1 (for alkali earth metals)  = 2 (for alkali metals)  Z = stoichiometric number of O = 1 </p>

Table 8-9: Emission factors for process emissions from other process materials (production of iron or steel, and processing of ferrous metals) <sup>(184)</sup>

Input or output material	Carbon content (t C/t)	Emission factor (t CO <sub>2</sub> /t)
Direct reduced iron (DRI)	0,0191	0,07
EAF carbon electrodes	0,8188	3,00
EAF charge carbon	0,8297	3,04
Hot briquetted iron	0,0191	0,07
Oxygen steel furnace gas	0,3493	1,28
Petroleum coke	0,8706	3,19
Pig iron	0,0409	0,15
Iron / iron scrap	0,0409	0,15
Steel / steel scrap	0,0109	0,04

<sup>(184)</sup> IPCC 2006 Guidelines for National Greenhouse Gas Inventories

## Global warming potentials for non-CO<sub>2</sub> greenhouse gases

Table 8-10: Global warming potentials

Gas	Global warming potential
N <sub>2</sub> O	265 t CO <sub>2</sub> e / t N <sub>2</sub> O
CF <sub>4</sub>	6 630 t CO <sub>2</sub> e / t CF <sub>4</sub>
C <sub>2</sub> F <sub>6</sub>	11 100 t CO <sub>2</sub> e / t C <sub>2</sub> F <sub>6</sub>

## ANNEX IX – Harmonised efficiency reference values for separate production of electricity and heat

In the tables below the harmonised efficiency reference values for separate production of electricity and heat are based on net calorific value and standard atmospheric ISO conditions (15 °C ambient temperature, 1,013 bar, 60 % relative humidity).

Table 8-11: Reference efficiency factors for electricity production

Category		Type of fuel	Year of construction		
			Before 2012	2012-2015	From 2016
<b>Solids</b>	S1	Hard coal including anthracite, bituminous coal, sub-bituminous coal, coke, semi-coke, pet coke	44,2	44,2	44,2
	S2	Lignite, lignite briquettes, shale oil	41,8	41,8	41,8
	S3	Peat, peat briquettes	39,0	39,0	39,0
	S4	Dry biomass including wood and other solid biomass including wood pellets and briquettes, dried woodchips, clean and dry waste wood, nut shells and olive and other stones	33,0	33,0	37,0
	S5	Other solid biomass including all wood not included under S4 and black and brown liquor	25,0	25,0	30,0
	S6	Municipal and industrial waste (non-renewable) and renewable/bio-degradable waste	25,0	25,0	25,0
<b>Liquids</b>	L7	Heavy fuel oil, gas/diesel oil, other oil products	44,2	44,2	44,2
	L8	Bio-liquids including bio-methanol, bioethanol, bio-butanol, biodiesel, and other bio-liquids	44,2	44,2	44,2
	L9	Waste liquids including biodegradable and non-renewable waste (including tallow, fat and spent grain)	25,0	25,0	29,0
<b>Gaseous</b>	G10	Natural gas, LPG, LNG and biomethane	52,5	52,5	53,0
	G11	Refinery gases hydrogen and synthesis gas	44,2	44,2	44,2
	G12	Biogas produced from anaerobic digestion, landfill, and sewage treatment	42,0	42,0	42,0
	G13	Coke oven gas, blast furnace gas, mining gas, and other recovered gases (excluding refinery gas)	35,0	35,0	35,0
<b>Other</b>	O14	Waste heat (including high temperature process exhaust gases, product from exothermic chemical reactions)			30,0

Table 8-12: Reference efficiency factors for heat production

Category		Type of fuel	Year of construction					
			Before 2016			From 2016		
			Hot water	Steam <sup>(185)</sup>	Direct use of exhaust gases <sup>(186)</sup>	Hot water	Steam <sup>(185)</sup>	Direct use of exhaust gases <sup>(186)</sup>
<b>Solids</b>	S1	Hard coal including anthracite, bituminous coal, sub-bituminous coal, coke, semi-coke, pet coke	88	83	80	88	83	80
	S2	Lignite, lignite briquettes, shale oil	86	81	78	86	81	78
	S3	Peat, peat briquettes	86	81	78	86	81	78
	S4	Dry biomass including wood and other solid biomass including wood pellets and briquettes, dried woodchips, clean and dry waste wood, nut shells and olive and other stones	86	81	78	86	81	78
	S5	Other solid biomass including all wood not included under S4 and black and brown liquor	80	75	72	80	75	72
	S6	Municipal and industrial waste (non-renewable) and renewable/bio-degradable waste	80	75	72	80	75	72
<b>Liquids</b>	L7	Heavy fuel oil, gas/diesel oil, other oil products	89	84	81	85	80	77

<sup>(185)</sup> If steam plants do not account for the condensate return in their calculation of CHP (combined heat and power) heat efficiencies, the steam efficiencies shown in the table above shall be increased by 5 percentage points.

<sup>(186)</sup> Values for direct use of exhaust gases shall be used if the temperature is 250 °C or higher.

Category	Type of fuel	Year of construction						
		Before 2016			From 2016			
		Hot water	Steam <sup>(185)</sup>	Direct use of exhaust gases <sup>(186)</sup>	Hot water	Steam <sup>(185)</sup>	Direct use of exhaust gases <sup>(186)</sup>	
	L8	Bio-liquids including bio-methanol, bioethanol, bio-butanol, biodiesel, and other bio-liquids	89	84	81	85	80	77
	L9	Waste liquids including biodegradable and non-renewable waste (including tallow, fat and spent grain)	80	75	72	75	70	67
<b>Gaseous</b>	G10	Natural gas, LPG, LNG and biomethane	90	85	82	92	87	84
	G11	Refinery gases hydrogen and synthesis gas	89	84	81	90	85	82
	G12	Biogas produced from anaerobic digestion, landfill, and sewage treatment	70	65	62	80	75	72
	G13	Coke oven gas, blast furnace gas, mining gas, and other recovered gases (excluding refinery gas)	80	75	72	80	75	72
<b>Other</b>	O14	Waste heat (including high temperature process exhaust gases, product from exothermic chemical reactions)	—	—	—	92	87	—